

NOVEMBER 1, 1957

electronics

engineering edition

A MCGRAW-HILL PUBLICATION • PRICE ONE DOLLAR

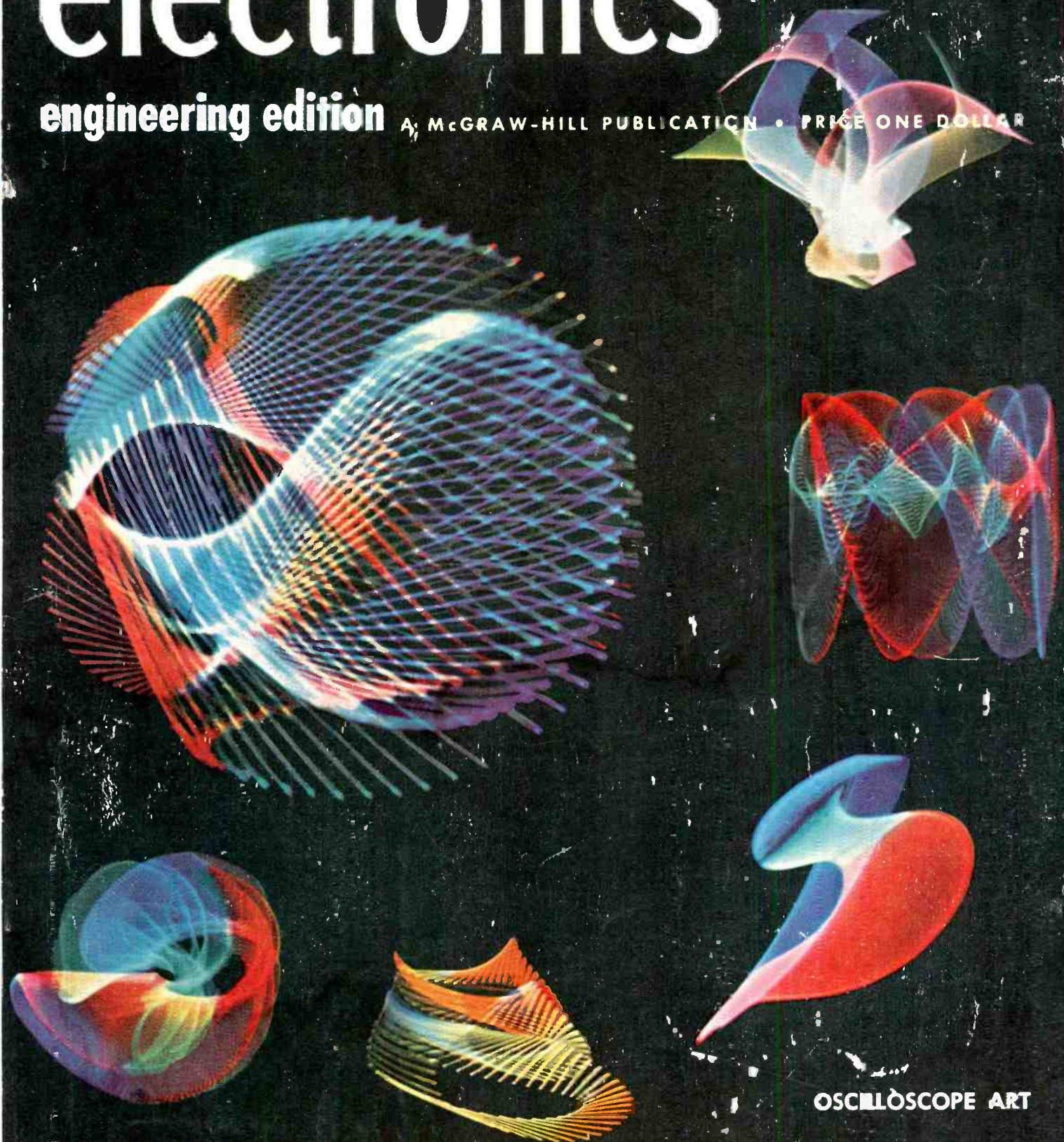

OSCILLOSCOPE ART

Target for Missile Tests page 141

New Semiconductors page 144



DO-TS

Deci-Ouncer Transformers

REVOLUTIONARY TRANSISTOR TRANSFORMERS

of unequalled power handling capacity and reliability

Hermetically Sealed to MIL-T-27A Specs.

TYPICAL DO-T PERFORMANCE CURVES

Power curves based on setting output power at 1 KC, then maintaining same input level over frequency range.

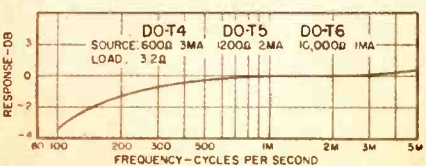
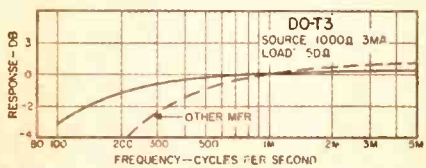
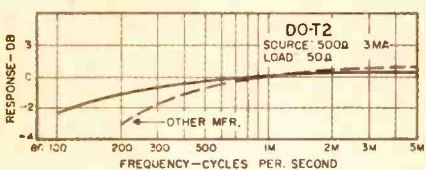
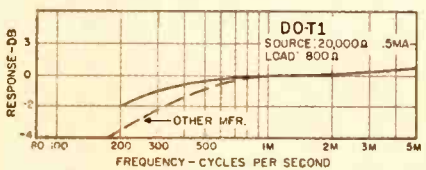
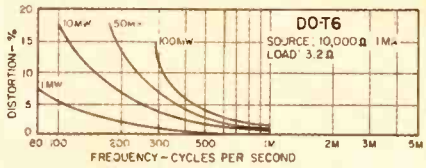
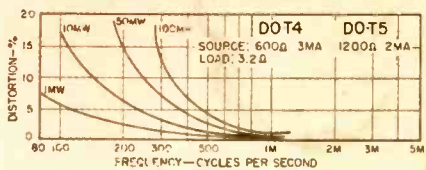
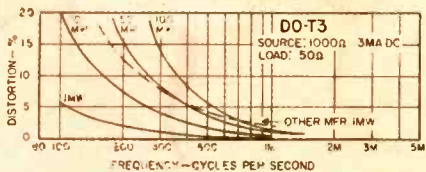
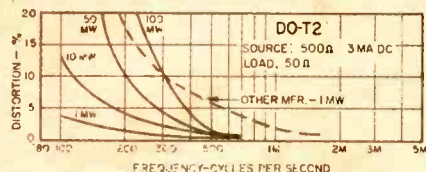
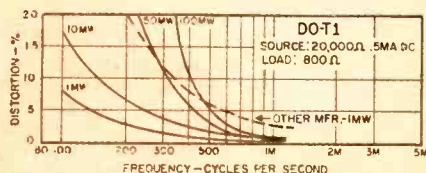

Conventional miniaturized transistor transformers have inherently poor electrical characteristics, perform with insufficient reliability and are woefully inadequate for many applications. The radical design of the new UTC DO-T transistor transformers** provides unprecedented power handling capacity and reliability, coupled with extremely small size. Twenty-five stock types cover virtually every transistor application*. Special types can be made to order.

High Power Rating . . . up to 100 times greater.

Excellent Response . . . twice as good at low end.

Low Distortion . . . reduced 80%.

High Efficiency . . . up to 30% better.

Moisture Proof . . . hermetically sealed to MIL-T-27A.

Rugged . . . completely cased

Anchored Leads . . . will withstand 10 pound pull test.

Printed Circuit Use . . . (solder melting) plastic insulated leads.

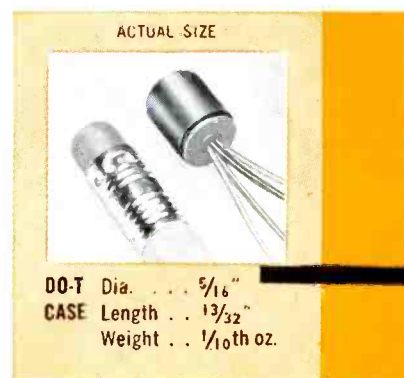

Type No.	MIL Type	Application	Pri. Imp.	D.C. Ma.† in Pri.	Sec. Imp.	Pri. Res.	Level Mw.
DO-T1	TF4RX13YY	Interstage	20,000 30,000	.5 5	800 1200	850	50
DO-T2	TF4RX17YY	Output	500 600	3 3	50 60	60	100
DO-T3	TF4RX13YY	Output	1000 1200	3 3	60 60	115	100
DO-T4	TF4RX17YY	Output	600	3	3.2	60	100
DO-T5	TF4RX13YY	Output	1200	2	3.2	115	100
DO-T6	TF4RX13YY	Output	10,000	J	3.2	1000	100
DO-T7	TF4RX16YY	Input	200,000	0	1000	8500	25
DO-T8	TF4RX20YY	Reactor 3.5 Hys. @ 2 Ma. DC				630	
DO-T9	TF4RX13YY	Output or driver	10,000 12,500	1 1	500 CT 600 CT	800	100
DO-T10	TF4RX13YY	Driver	10,000 12,500	1 1	1200 CT 1500 CT	800	100
DO-T11	TF4RX13YY	Driver	10,000 12,000	J 1	2000 CT 2500 CT	800	100
DO-T12	TF4RX17YY	Single or PP output	150 CT 200 CT	10 10	12 16	11	500
DO-T13	TF4RX17YY	Single or PP output	300 CT 400 CT	7 7	12 16	20	500
DO-T14	TF4RX17YY	Single or PP output	600 CT 800 CT	5 5	12 16	43	500
DO-T15	TF4RX17YY	Single or PP output	800 CT 1070 CT	4 4	12 16	51	500
DO-T16	TF4RX13YY	Single or PP output	1000 CT 1330 CT	3.5 3.5	12 16	71	500
DO-T17	TF4RX13YY	Single or PP output	1500 CT 2000 CT	3 3	12 16	108	500
DO-T18	TF4RX13YY	Single or PP output	7500 CT 10,000 CT	1 1	12 16	505	200
DO-T19	TF4RX17YY	Output to line	300 CT	7	600	19	500
DO-T20	TF4RX17YY	Output or matching to line	500 CT	5.5	600	31	500
DO-T21	TF4RX17YY	Output to line	900 CT	4	600	53	500
DO-T22	TF4RX13YY	Output to line	1500 CT	3	600	86	500
DO-T23	TF4RX13YY	Interstage	20,000 CT 30,000 CT	.5 .5	800 CT 1200 CT	850	100
DO-T24	TF4RX16YY	Input (usable for chopper service)	200,000 CT	0	1000 CT	8500	25
DO-T25	TF4RX13YY	Interstage	10,000 CT 12,000 CT	1 1	1500 CT 1800 CT	800	100

†DCMA shown is for single ended useage (under 5% distortion—100MW—1KC) . . . for push pull, DCMA can be any balanced value taken by .5W transistors (under 5% distortion—500MW—1KC)

UNITED TRANSFORMER CORP.

150 Varick Street, New York 13, N. Y.

PACIFIC MFG. DIVISION: 4008 W. JEFFERSON BLVD., LOS ANGELES 16, CALIF.

EXPORT DIVISION: 13 EAST 40th STREET, NEW YORK 16, N. Y. CABLES: "ARLAB"

*DO-T units have been designed for transistor application only . . . not for vacuum tube service. **Pats. Pending

ISSUE AT A GLANCE

H. W. MATEER, *Publisher*

W. W. MacDONALD, *Editor*

Managing Editor, John M. Carroll.

Feature Editor, John Markus.

Associate Editors: John M. Kinn, Jr., Frank Leary, Michael F. Tomaino, Howard K. Janis, Sylvester P. Carter, David A. Findlay, Haig A. Manoogian, Roland J. Charest, Donald C. Hoefler.

Assistant Editors: William P. O'Brien, George Sideris, Edward DeJongh, John F. Mason, Barry Miller.

Pacific Coast Editor (Los Angeles) Harold C. Hood; *Midwestern Editor* (Chicago) Harold Harris.

Art Director, Harry Phillips. Roy Thompson.

Production Editor, John C. Wright, Jr. Bernice Duffy, Jean L. Matin.

Editorial Assistants: Gloria J. Filippone, Arlene Schilp, Barbara Hearst, Noreen Hennessy, Phyllis A. Cronin, Barbara Habermann.

JAMES GIRDWOOD, *Advertising Sales Manager*. R. S. Quint, *Assistant Advertising Sales Manager and Buyer's Guide Manager*. Fred Stewart, *Promotion Manager*. Frank H. Ward, *Business Manager*. George E. Pomeroy, *Classified Manager*. Jean Heiges, *Research*. Wallace B. Blood, *Market Consultant*.

New York: Donald H. Miller, Henry M. Shaw, Martin J. Gallay. *Boston*: Wm. S. Hodgkinson. *Philadelphia*: James T. Hauptli. *Chicago*: Bruce Winner, Walter M. Luce. *Cleveland*: Warren H. Gardner. *San Francisco*: T. H. Carmody, R. C. Alcorn. *Los Angeles*: Carl W. Dysinger, Russell H. Antles. *Atlanta*: M. Miller. *Dallas*: Gordon L. Jones. *Denver*: J. Patten. *London*: Herbert Lagler.

Keith Henney, *Consultant*.

Oscilloscope Art. Oscillators, phase-splitting networks and color wheel on scope face produce abstract geometrical patterns. (See p 198).....COVER

By Ben F. Laposky

Photoelectric Target for Missile Tests. Rectangular coordinates of test missile can be determined by two banks of multiplier phototubes.....p 141

By Samuel E. Dorsey

Semiconductor Compounds Open New Horizons. Characteristics, unusual properties and applications are covered in this comprehensive survey.....p 144

By Abraham Coblentz

Thyratrons Improve Mobile Phone Operation. Trigger-tube counters replace electromechanical selector in vehicle telephone.....p 150

By W. Ornstein

Jukebox and Tape Automate Radio Shows. Dual-track recording of program material and control signals permits studio automation for small broadcasters.....p 156

By John K. Birch

Tones Monitor Heart's Electrical Action. Heart's electrical signal controls frequency of neon-tube oscillator providing surgeon with audio monitor..p 160

By Albert J. Morris and Joseph P. Swanson

R-F Power Supply for Infrared Viewers. Electron-coupled r-f oscillator supplies noise-free high voltage for sniperscopes or snooperscopes.....p 163

By T. Fujii and H. Kojima

Electronics Controls Gas Chromatograph. Heat-controlled system maintains preset temperature between 40 and 225 C within thermal compartment. Precision voltage regulator supplies 2 to 4 volts at maximum of 400 ma.....p 164

By Walt Donner

Transmitter Cost Trimmed by Series Gate Modulator. Low-level modulator achieves high-level efficiency and splatter-free clipping in small package.p 167

By Ralph H. Baer

Gamma-Ray Monitor Has High Reliability. Transistorized unit detects gamma radiation over 1 to 1,000 mr per hr range with accuracy of ± 40 percent.p 170

By J. M. Jackson and J. J. Suran

CONTENTS continued

- Phase Generator Has Resistive Shifter.** Signal generator using phase-shifting network produces two sinusoidal signals with known phase relation. . . p 175
By George E. Pihl
- Transistorized AFC Uses Triangular Search Sweep.** Multivibrator with zener diodes holds 30-mc i-f of radar system within 200-kc bandwidth. . . . p 178
By H. H. Hoge and D. L. Spotten
- Designing Oscillators for Greater Stability.** Oscillator circuits using surface-barrier transistors are designed by new method that improves stability. . . p 180
By Samuel N. Witt, Jr.
- Designing Tapered Waveguide Transitions.** A graphical procedure for designing tapered matching sections where wavelength varies along the taper. p 183
By Bernard J. Migliaro
- Binary-Decimal Counter Operates at 10 Mc.** Counter uses logical and gates in feedback loop to convert from binary to binary-decimal form. . . . p 186
By Donald E. Cottrell
- Coaxial Line Impedance Chart (Reference Sheet).** Characteristic impedances are related to dielectric constants and conductor diameter ratios. p 190
By Herbert L. Levin
- Parallel-T Nomograph (Reference Sheet).** Values of five parameters for parallel-T frequency-eliminating network are given with one reading. p 192
By Donald F. Carter

FIGURES OF THE MONTH p 6

INDUSTRY REPORT p 7

ELECTRONS AT WORK p 194

- | | |
|---|---|
| Electronic Equipment Cooling. 194 | Back Window Cathode Ray Tube. 202 |
| Radar Telemetering Trains Pilots. 194 | Low-Voltage Color-Tube Gun. 204 |
| Indicator for Color TV Tuning. 194 | Balancing Automobile Engines. 208 |
| Ridge Vane Antenna. 196 | Increasing Recorder Resolution. 210 |
| By William A. Scanga | By N. D. Diamantides |
| The Front Cover. 198 | Avoiding Blown Fuses. 218 |
| Mobile Radar Uses Balloon | By Sergio Bernstein |
| Antenna. 198 | Magic Tee Technique. 230 |
| Dielectric Recorder. 200 | By Alan C. Macpherson |

PRODUCTION TECHNIQUES p 234

- | | |
|--|---|
| Blank Printed Circuit Cards. 234 | 3-D Packaging for Circuits. 244 |
| By L. Lindgreen and A. Osborn | By John A. Werek, Jr. |
| Molding Pressure Seals. 236 | Nylon-Insert Screws. 254 |
| Design of Month: Strain Cells. 236 | Choosing Radome Materials. 256 |
| Machine Inserts Components. 238 | By Hugh O. Pierson |
| Wrappable Magnetic Shields. 238 | Plastic Protects Work Orders. 268 |
| Vacuum-Evaporated | Capacitors. 270 |

NEW PRODUCTS p 272

LITERATURE p 358

PLANTS AND PEOPLE p 360

NEW BOOKS p 382

THUMBNAIL REVIEWS p 385

LETTERS p 387

INDEX TO ADVERTISERS p 417

electronics

November 1, 1957 Vol. 30, No. 11

Published three times a month with an additional issue in June, by McGraw-Hill Publishing Company, Inc., James H. McGraw (1860-1948) Founder.

Executive, Editorial, Circulation and Advertising Offices: McGraw-Hill Building, 330 W. 42 St., New York 36, N. Y.

Longacre 4-3000. Publication Office 99-129 North Broadway, Albany 1, N. Y. See panel below for directions regarding subscription on change of address. Donald C. McGraw, President; Joseph A. Gerardi, Executive Vice President; L. Keith Goodrich, Vice President and Treasurer; John J. Cooke, Secretary; Nelson Bond, Executive Vice President, Publications Division; Ralph B. Smith, Vice President and Editorial Director; Joseph H. Allen, Vice President and Director of Advertising Sales; A. R. Venezian, Vice President and Circulation Coordinator.

Single copies \$1.00 for Engineering Edition and 50¢ for Business Edition in United States and possessions, and Canada: \$2.00 and \$1.00 for all other foreign countries. Buyers' Guide \$3.00. Subscription rates—United States and possession, \$6.00 a year; \$9.00 for two years. Canada, \$10.00 a year, \$16 for two years. All other countries \$20.00 a year, \$30.00 for two years. Three year rates accepted on renewals only, are double the one-year rate. Second class mail privileges authorized at Albany, N. Y. Printed in U.S.A. Copyright 1957 by McGraw-Hill Publishing Co., Inc.—All Rights Reserved. Title registered in U. S. Patent Office. BRANCH OFFICES: 520 North Michigan Avenue, Chicago 11; 68 Post Street, San Francisco 4; McGraw-Hill House, London E. C. 4; National Press Bldg., Washington, D. C. 4; Architects Bldg., 17th & Sansom Sts., Philadelphia 3; 1111 Henry W. Oliver Bldg., Pittsburgh 22; 1510 Hanna Bldg., Cleveland 15; 856 Penobscot Bldg., Detroit 26; 3615 Olive St., St. Louis 8; 350 Park Square Bldg., Boston 16; 1321 Rhodes Haverly Bldg., Atlanta 3; 1125 West Sixth St., Los Angeles 17; 1740 Broadway, Denver. ELECTRONICS is indexed regularly in The Engineering Index.

Subscriptions: Address correspondence to Subscription Manager, Electronics, 330 W. 42nd St., New York 36, N. Y. Allow one month for changes of address, stating old as well as new address. Subscriptions are solicited only from persons engaged in theory, research, design, production, maintenance and use of electronic and industrial control components, parts and products. Position and company connection must be indicated on subscription orders.

Postmaster: please send form 3579 to Electronics, 330 W. 42 St., New York 36, N. Y.



Member ABC and ABP

November 1, 1957 — ELECTRONICS

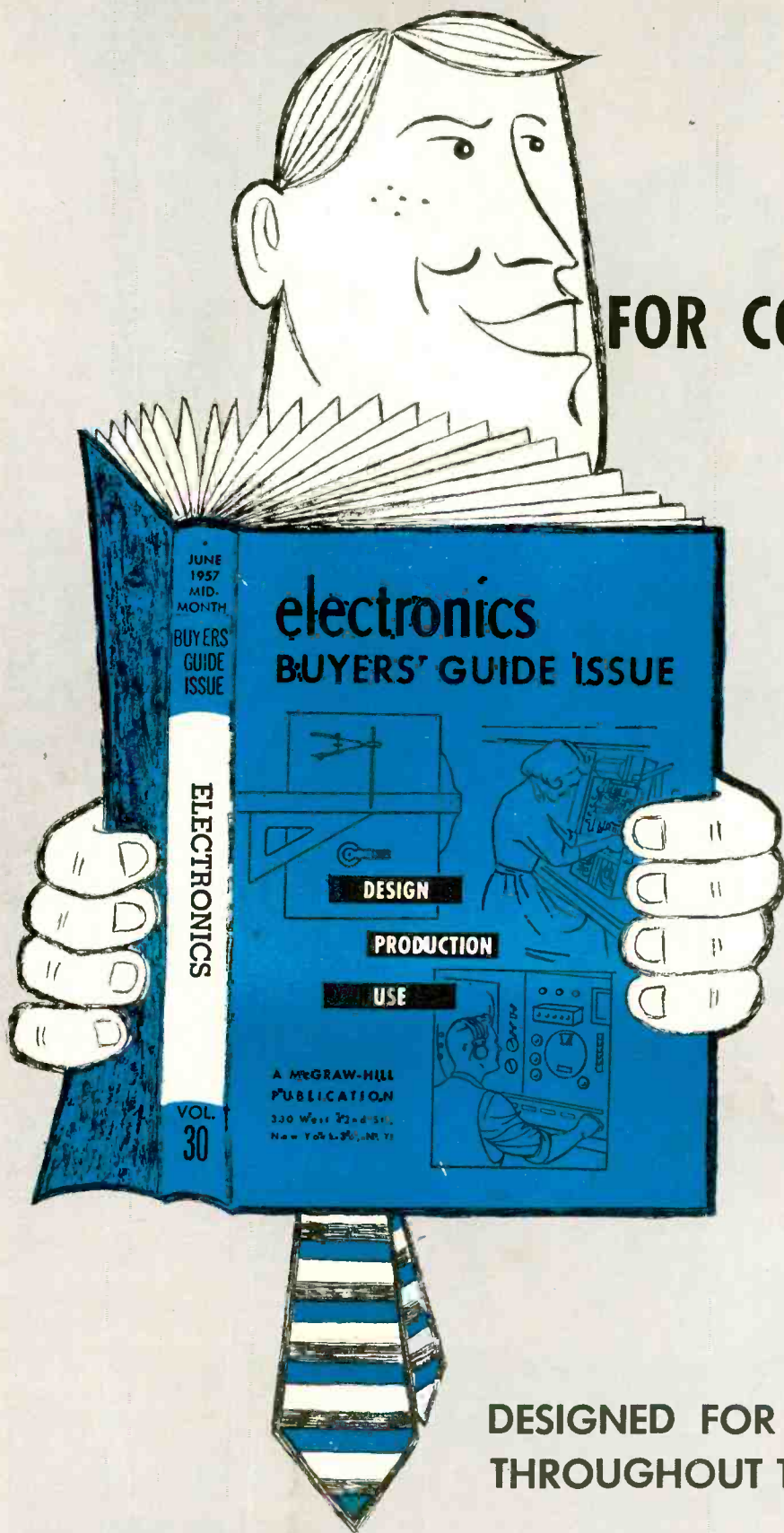

FOR COMPLETENESS

After a year of intensive research, questionnairing, verifying and collating . . . electronics has published its most comprehensive and informative edition of the BUYERS' GUIDE to come off the press thus far.

For users, designers and producers of electronic and allied equipment and services, the 1957 electronics BUYERS' GUIDE (now in your hands) features an alphabetical product listing with all advertisers' names bold-faced and page-numbered. It contains an industry-wide Index of Manufacturers of better than 4,000 names. Included are 14 pages of manufacturers' representatives, 700 pages of catalog-type advertisements revealing the most complete designs and specifications of electronic and allied equipment for your easy reference, 25 pages of listings and guides for the buying of used equipment, professional services and an Index for Advertisers. Also of great importance are the 64 pages of useful editorial feature articles that provide lasting reference type technical material.

It all adds up to 1,070 pages of the most valuable, reliable and complete buying and data sources available today. It is no wonder to us that the electronics BUYERS' GUIDE is called the working tool of the electronic industry. It has been . . .

DESIGNED FOR YOUR DAILY USE THROUGHOUT THE COMING YEAR

electronics BUYERS' GUIDE

A MCGRAW-HILL PUBLICATION

330 WEST 42ND STREET • NEW YORK 36, NEW YORK



That's My NOBATRON®!

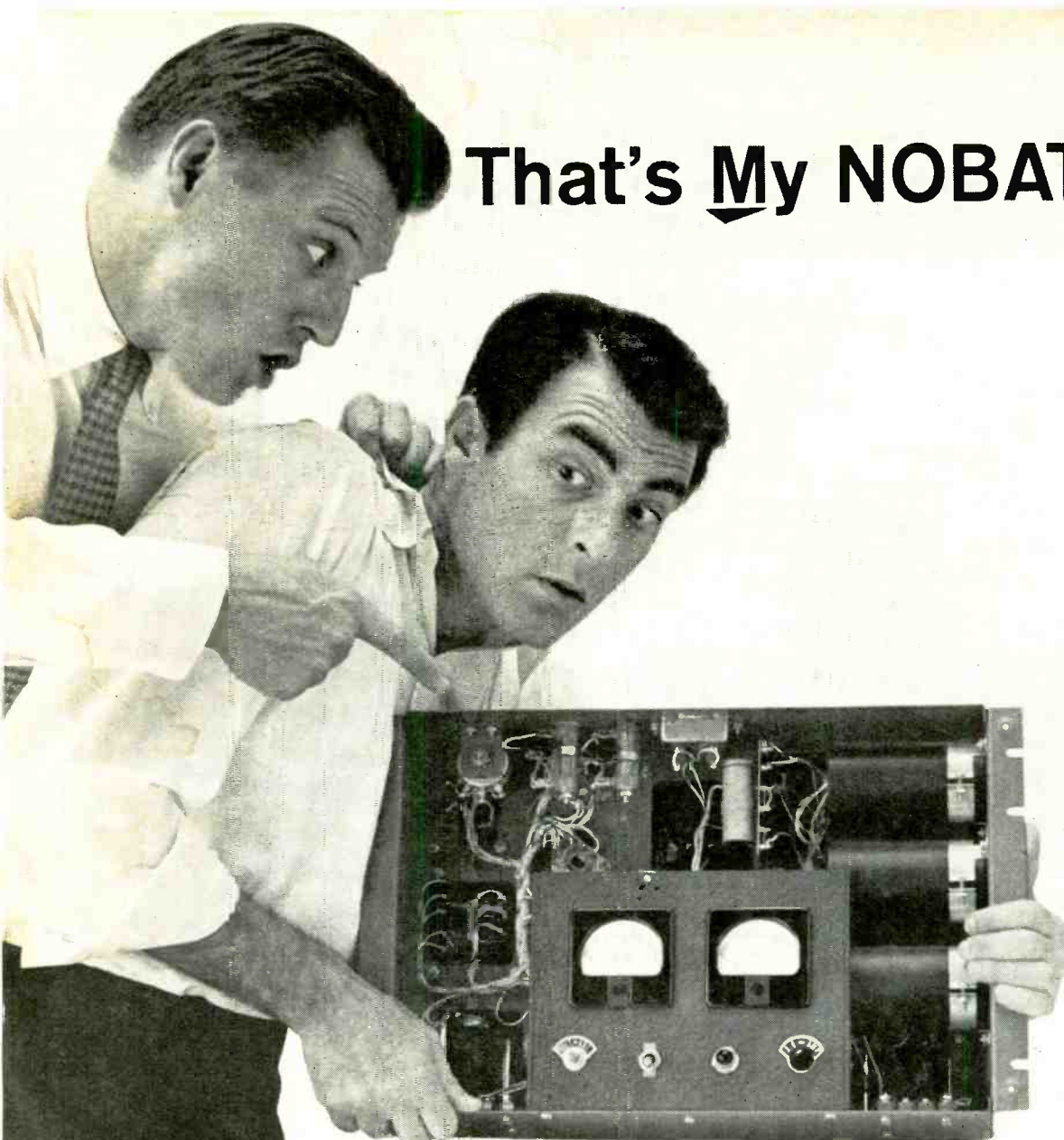

Regulated DC Sources for Low-Voltage High-Current— 6, 12, 28, 48, 125, 200 Volts at 5 to 75 Amps.

For a reliable *sustained* low-voltage DC supply, delivering the power that covers most laboratory and many industrial applications, and with voltage variation held within $\pm 0.2\%$... these Nobatrons just can't be matched — by anything, anywhere.

Nobatrons are in use, by the thousands, all over the world. Many of them have been in operation continuously over a span of years. Conservative design and generous specifications insure long life—especially for wound components.

So effective is the Sorensen regulating principle in correcting line and load drops that output has the stability of a battery supply over extended periods. And the

disadvantages of batteries—recharging, acid handling, fixed voltage, temperature problems—are eliminated.

Over-voltage protection is assured by a special safety diode that impels a voltage drop in case of filament failure, with other protective devices safe-guarding all components against power surge.

Most units are designed for rack-mounting, and with cabinets for bench use.

Let your local Sorensen representative give you complete data on these Sorensen DC Nobatrons or write directly for specific information. Please address **SORENSEN & COMPANY, Inc.**, Richards Avenue, South Norwalk, Connecticut.

TYPICAL SPECIFICATIONS Model E-28-5* (illustrated)

Output Voltage	28 VDC, Adjustable $\pm 10\%$ with rated accuracy	Load Range	0.5 to 5 Amps at Rated Accuracy; accuracy decreases to around $\pm 0.5\%$ for no load.
Input Voltage	95-130 VAC, single phase, 50/60 cycles.	Ripple Voltage	1% RMS at 60 cycles. Filters available to reduce ripple to 0.1%
Regulation Accuracy	$\pm 0.2\%$ against line from 105 to 125 VAC Input; $\pm 0.2\%$ against load.	Time Constant	0.2 second
		Size	Rack height 12 $\frac{1}{4}$ " Cabinet Size 21 $\frac{3}{4}$ " x 14" x 15"

*Write for data on other models and capacities.

Sorensen CONTROLLED POWER FOR
RESEARCH AND INDUSTRY

F.M. DEVIATION *Directly Measured*



with this time-saving and accurate MARCONI instrument

If you haven't a deviation meter you can use the Bessel Zero or "Disappearing Carrier" method of measurement; this, however, requires complex monitoring equipment, an accurately-known modulation frequency, and, finally, mathematical interpretation of results.

With the compact and easy-to-use Marconi Deviation Meter, the modulation frequency need not be known and deviation is read *directly* from the panel meter.

F.M. DEVIATION METER

MODEL TF 934/2

Carrier Frequency Range:
2.5 to 500 Mc.

Deviation Measurement Ranges:
5, 25, and 75 kc full-scale.

Accuracy of Deviation
Measurement:
±3% from full-scale to half-scale for
modulation frequencies up to 12 kc;
±6% up to 15 kc.

Tubes:
6AK5, 6AL5, 6C4, 6X5, 6B2.

BESSEL ZERO METHOD

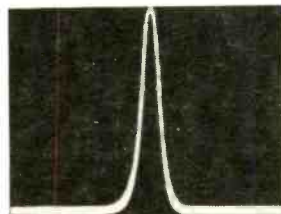

Unmodulated Carrier

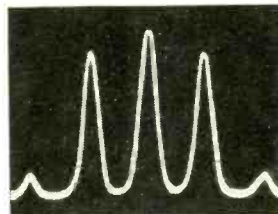

Modulation Index 1.3

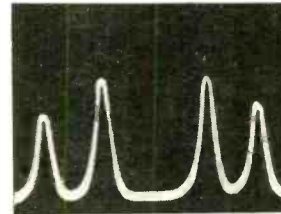

Modulation Index 2.4
The Carrier "Disappears"

MARCONI INSTRUMENTS

AM & FM SIGNAL GENERATORS · AUDIO & VIDEO OSCILLATORS · FREQUENCY METERS · VOLTMETERS · POWER METERS · DISTORTION METERS
FIELD STRENGTH METERS · TRANSMISSION MONITORS · DEVIATION METERS · OSCILLOSCOPES, SPECTRUM & RESPONSE ANALYSERS · Q METERS & BRIDGES

Full data and prices will be mailed immediately on request.

44 NEW STREET · NEW YORK 4

CANADIAN MARCONI COMPANY, 6035 COTE DE LIESSE, MONTREAL 9, CANADA

HEAD OFFICE: MARCONI INSTRUMENTS LTD · ST. ALBANS · HERTS · ENGLAND

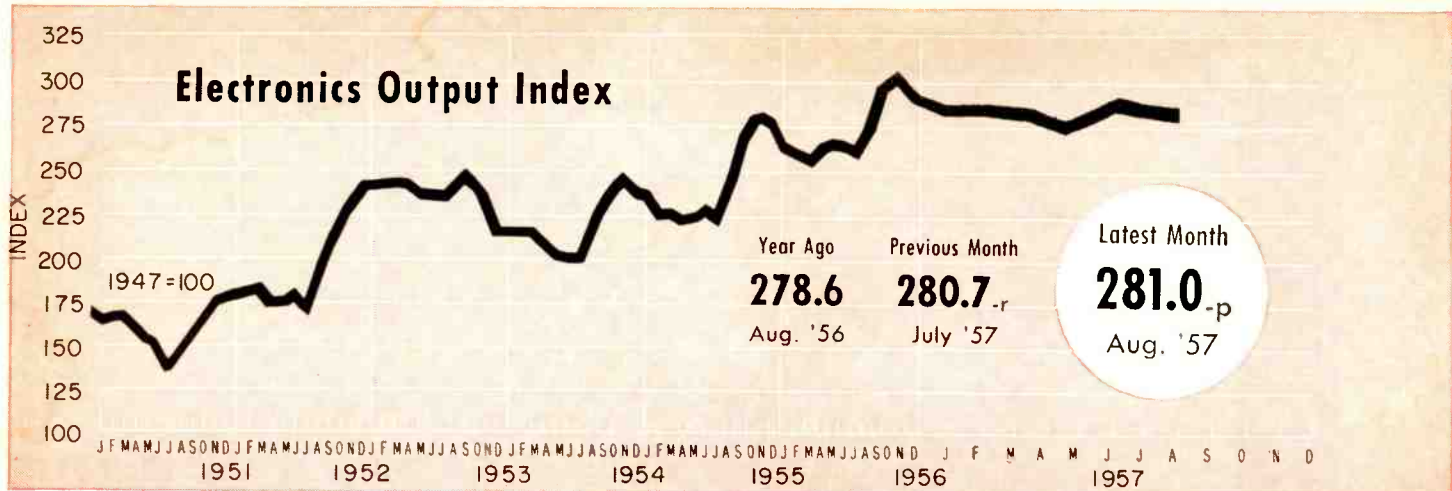

FIGURES OF THE MONTH

	Latest Month	Previous Month	Year Ago
RECEIVER PRODUCTION			
(Source: RETMA)	August '57	July '57	August '56
Television sets, total	673,734	360,660	612,927
With UHF	88,615	55,401	90,419
Color sets	nr	nr	nr
Radio sets, total	965,724	612,588	990,845
Auto sets	301,971	256,279	198,087

	Latest Month	Previous Month	Year Ago
RECEIVER SALES			
(Source: RETMA)	August '57	July '57	August '56
Television sets, units	510,097	426,334 -r	566,158
Radio sets (except auto)	710,553	597,484	681,152

	Latest Month	Previous Month	Year Ago
RECEIVING TUBE SALES			
(Source: RETMA)	August '57	July '57	August '56
Receiv. tubes, total units	43,029,000	33,077,000	43,948,000
Receiv. tubes, value	\$34,886,000	\$27,042,000	\$34,507,000
Picture tubes, total units	930,296	491,935	1,099,605
Picture tubes, value	\$17,984,185	\$9,835,586	\$19,628,837

	Quarterly Figures		
	Latest Quarter	Previous Quarter	Year Ago
(Source: NEMA)	2nd '57	1st '57	2nd '56
Vacuum	\$10,191,621	\$11,224,707	\$7,680,250
Gas or vapor	\$2,758,630	\$3,332,357	\$2,983,488
Magnetrons and velocity modulation tubes	\$17,177,922	\$15,359,108	\$16,254,025
Gaps and T/R boxes	\$1,589,670	\$1,409,463	\$1,238,469

	1st '57	4th '56	1st '56
MILITARY PROCUREMENT			
(Source: Defense Dept.)	1st '57	4th '56	1st '56
Army	\$69,381,000	\$56,185,000	\$40,490,000
Navy	\$21,426,000	\$34,210,000	\$28,700,000
Air Force	\$159,829,000	\$145,962,000	\$124,828,000
Total—Electronics	\$250,636,000	\$236,357,000	\$194,018,000

	Latest Month	Previous Month	Year Ago
BROADCAST STATIONS			
(Source: FCC)	July '57	June '57	July '56
TV stations on air	522	519	499
TV stations CPs—not on air	132	132	116
TV stations—new requests	78	79	42
A-M stations on air	3,095	3,079	2,922
A-M stations CPs—not on air	155	159	119
A-M stations—new requests	340	322	263
F-M stations on air	531	530	530
F-M stations CPs—not on air	31	31	19
F-M stations—new requests	25	24	7

	Latest Month	Previous Month	Year Ago
COMMUNICATION AUTHORIZATIONS			
(Source: FCC)	July '57	June '57	July '56
Aeronautical	51,463	49,699	49,639
Marine	64,067	63,844	57,529
Police, fire, etc.	23,550	23,270	20,943
Industrial	36,261	35,711	30,776
Land transportation	9,652	9,592	9,027
Amateur	163,994	160,000	149,032
Citizens radio	28,864	27,931	19,253
Disaster	347	347	327
Experimental	797	788	722
Common carrier	2,856	2,790	2,356

	Latest Month	Previous Month	Year Ago
EMPLOYMENT AND PAYROLLS			
(Source: Bur. Labor Statistics)	July '57	June '57	July '56
Prod. workers, comm. equip.	395,600-p	394,200	379,700
Av. wkly. earnings, comm.	\$75.85 -p	\$79.59 -r	\$73.30
Av. wkly. earnings, radio	\$75.05 -p	\$76.97 -r	\$72.83
Av. wkly. hours, comm.	39.1 -p	40.4 -r	39.2
Av. wkly. hours, radio	39.5 -p	40.3 -r	39.8

	August '57	July '57	August '56
SEMICONDUCTOR SALES ESTIMATES			
Transistors, Units	2,709,000	1,703,000	1,315,000

	August '57	July '57	August '56
STOCK PRICE AVERAGES			
(Source: Standard and Poor's)	August '57	July '57	August '56
Radio-tv & electronics	47.28	51.56	57.84
Radio broadcasters	60.63	64.78	73.49

p—provisional r—revised nr—not reported

FIGURES OF THE YEAR

Television set production	8,765,606
Radio set production	3,746,834
Television set sales	4,947,006
Radio set sales (except auto)	297,281,000
Receiving tube sales	6,236,890
Cathode-ray tube sales	6,837,728

TOTALS FOR FIRST EIGHT MONTHS

	1957	1956	Percent Change	1956 Total
Television set production	3,756,533	4,365,060	-13.9	7,357,029
Radio set production	8,765,606	8,216,707	+ 6.7	13,981,800
Television set sales	3,746,834	3,839,718	- 2.4	6,804,756
Radio set sales (except auto)	4,947,006	4,648,707	+ 6.4	8,332,077
Receiving tube sales	297,281,000	303,004,000	- 1.9	464,186,000
Cathode-ray tube sales	6,236,890	6,837,728	- 8.8	10,987,021

INDUSTRY REPORT

electronics—November 1 • 1957

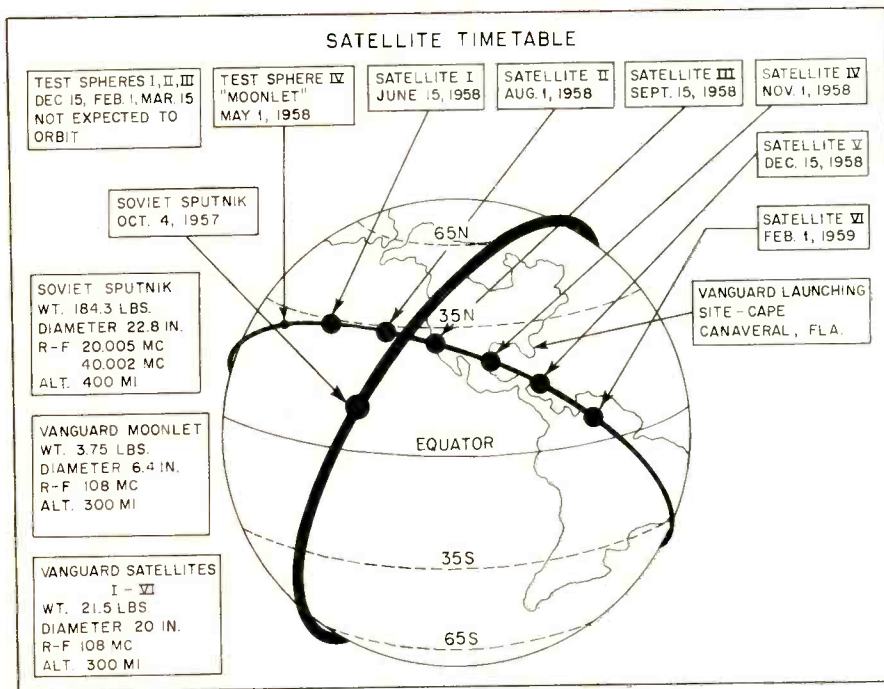

U. S. satellite orbits are yet to be filled, but . . .

Vanguard's Center Gets Rehearsal

Although unprepared for Sputnik, computer men gained valuable information

VANGUARD'S Computing Center has had a live and unexpected dress rehearsal in satellite orbit computations since Oct. 4 when the Soviet *Sputnik* highballed without warning into space.

Although ahead of schedule in preparation for *Vanguard*, the IBM center—under contract to the Naval Research Lab—was not yet prepared to go into high gear.

By 2:00 a.m. Saturday, the cen-

ter's IBM 704 computer was running. But reliable information to feed into it was scarce.

Directional orientation for both visual (Moonwatch) and Minitrack radio monitoring systems were set up for a satellite going in an east-west orbit from 35 degrees north latitude to 35 degrees south. *Sputnik* had been launched at a 65-degree inclination from the Equator and was careening up and down the Minitrack and Moonwatch stations in an almost north-south path.

Radio reception was ruled out for hours because *Sputnik's* transmit-

ting frequencies were too low for Minitrack. Frequency changes had to be made and visual equipment re-oriented north and south.

► **Sightings**—Visual observation reports began trickling in to the Smithsonian Astrophysical Observatory at MIT from observatories and universities. They were unreliable on two counts: they came from extreme latitudes like Alaska and Australia where exact coordinates were not known; and secondly, there was no assurance the observer had seen the actual satellite. *Sputnik's* nose cone and third-stage rocket were also caught up in orbits making already dubious sightings less usable still. Several sightings fed into the programmed 704 were promptly rejected by the computer as false.

By Tuesday afternoon, Oct. 8, the ten Minitrack stations had been converted to receive on 20.005 mc and 40.002 mc and nine stations had been heard from. But even this data was not completely reliable. One station received a steady signal from the satellite for 45 minutes—almost half way around the globe. Extremes of the signal were sky waves, giving erroneous positions.

► **Computations**—By carefully culling all data sent in, a minute-by-minute orbital computation was made 64 hours and some 2 billion calculations after the computer was started. Altitude and orbit shape were not clear but schedule and itinerary predictions have checked out with reasonable precision.

Data sources are ten Minitrack receiver stations, 150 teams of Moonwatchers with twelve optical

tracking cameras and the volunteer observatories and universities throughout the world.

Visual observations go to the Smithsonian Astrophysical Observatory at MIT while Minitrack data is sent in to NRL in Washington. From there, screened data is passed on by teletype to IBM's Vanguard Computing Center.

Recorded on punched-paper tape, data is fed through a tape-to-card converter and into the already-programmed computer.

The 704 is able, with only three accurate positions, to arrive at an orbit. Once an orbit is established, the launching site can be pinpointed.

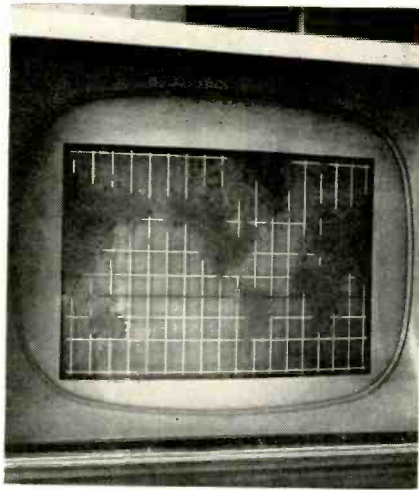

Visual presentation of orbiting satellite appears on IBM's type 780 cathode ray tube display unit

Computers Approach 5,000 Mark

Over 103 types now available for research and commercial applications

METEORIC RISE in the rate of computer investments sharply spotlights substantial computer growth. From ten million dollars per year invested in 1953, the rate rose to one hundred million dollars in 1956. Within the next few years expenditures should mushroom to one billion dollars per year.

This growth is reflected in a report on digital computers issued recently by the Office of Technical Services of the Department of Commerce. By early summer over 4,900 computers had been manufactured.

► **Cost**—Computer costs range from \$16,800 for the 46-tube Litton 40, a portable differential analyzer, to \$4,200,000 for the giant 30,000-tube RCA Bizmac. Of 103 computers surveyed nine units cost more than \$1,000,000 while 21 cost less than \$100,000.

► **Tubes**—Like computer costs, tube quantities vary from 30,000 in the Bizmac down to 40 in Logistics Research's ALWAC 800. Thirteen computers possess in excess of 5,000 tubes, but 33 have less than 1,000.

To ease replacement problems efforts have been made to standardize tube types in computers. For example, the 10,000-tube IBM 702 has three tube types, the 9,800-tube NORC has 20 and the 6,100-tube IBM 705 has ten.

► **Transistorization**—According to the report a trend toward transistorization is not yet apparent. Only three models, the IBM 608, the Livermore Automatic Research Calculator (LARC) and the Philco Transac S 1000 are completely transistorized. But nineteen other units, most notably the Lincoln TX2, employ some transistors.

Largest number of transistors are the 25,000 found in the TX2. National Bureau of Standards' SEAC, a general purpose scientific calculator, supplements 2,229 tubes with three transistors.

► **Crystal Diodes**—Consumption of crystal diodes in digital computers is considerable. The Bizmac uses 70,000. Twenty-two other models use in excess of 10,000. Less than 16 models have fewer than 1,000.

► **Arithmetic**—Speed of arithmetic operations varies considerably for different units.

Punched-Tape Robot Performs at NEC

Rumors of new assembly machines heard as one prototype makes operating debut

HARD-WORKING committees chalked up another success as the Hotel Sherman doors closed on the National Electronics Conference in Chicago. Final attendance was close to that for previous years. Once again, engineers enjoyed and profited from the quiet and leisurely pace of this show, in contrast to the noise, the crowds, and the rush-to-see-it-all of the annual IRE convention in New York.

► **On Duty**—A total of 230 booths this year had 879 scheduled attendants. In addition, top executives of many firms were to be seen at their booths, available for positive answers at management level to supplement the technical information provided by their engineers and sales staffs. As a result, booth coverage probably set an all-time high for the industry, and visitors seldom had to wait for answers to questions.

► **Get-Around Gimmick**—With exhibits spread through rooms on four different levels, some badly broken up by partitions, NEC management had a real problem in guiding and luring visitors to the most remote booths. Their highly effective solution—six time clocks and a redhead.

At the main entrance was a display table packed high with door prizes, a stack of time cards and charted instructions for reaching the time clocks at the remote corners of each room. A filled-in card, validated at each clock, was tossed into a barrel for the grand drawing at the end of the show. The curvaceous guide was strategically stationed at the stairs to the furthermost lower room, to coax dog-tired engineers down that last flight for coverage of 32 more booths. Success of this planning was evidenced by essentially uniform aisle popu-

(Continued on page 10)

plant
Burnell moves a ~~step~~ further
 in toroid, filter and
 related network leadership

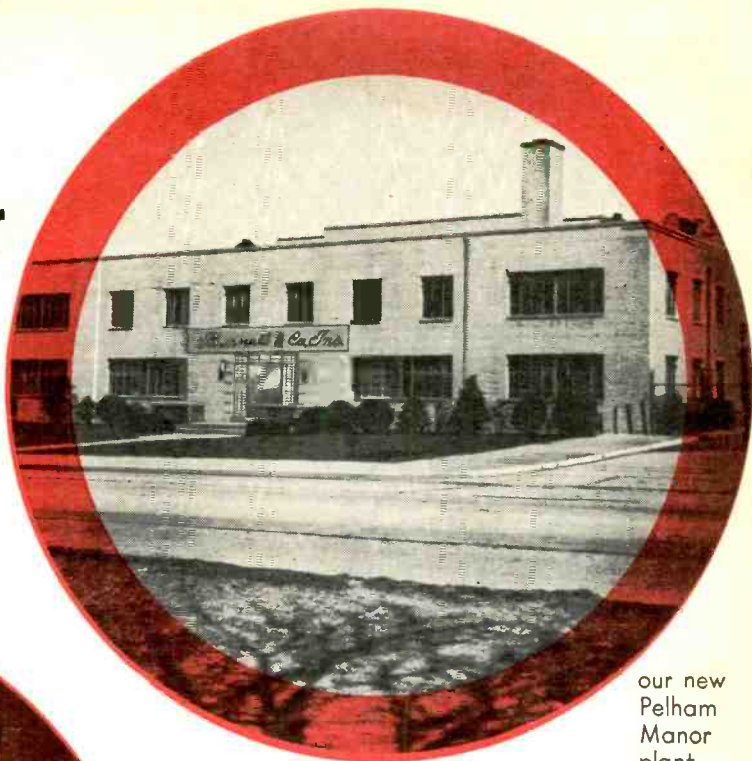

our new
 Pelham
 Manor
 plant

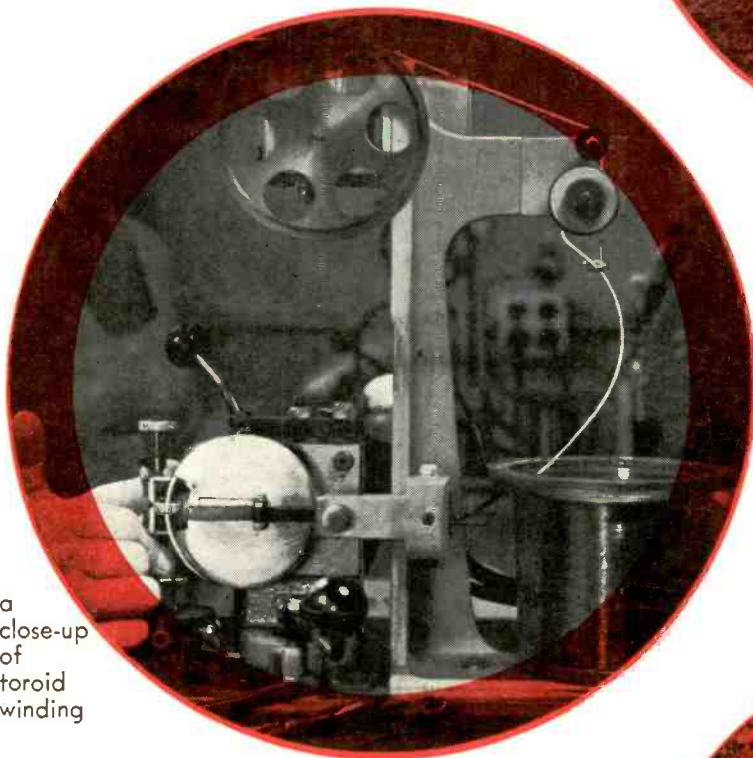

a
 close-up
 of
 toroid
 winding

Burnell & Co. is now producing toroids, filters, and related networks in its new Pelham Manor plant — largest and best equipped of its kind in the country. For customers, this means fast attention to samples, quicker delivery of orders, more solutions to network problems.

- look to Burnell to remain first in ...**
- advanced research**
 - product development**
 - new design ideas**
 - new circuit components**
 - new production methods**
 - economy**

Burnell & Co., Inc.

first . . . in toroids, filters, and related networks

EASTERN DIVISION
 10 PELHAM PARKWAY
 PELHAM MANOR
 NEW YORK



Dept. E117

PACIFIC DIVISION
 720 MISSION STREET
 SOUTH PASADENA
 CALIFORNIA

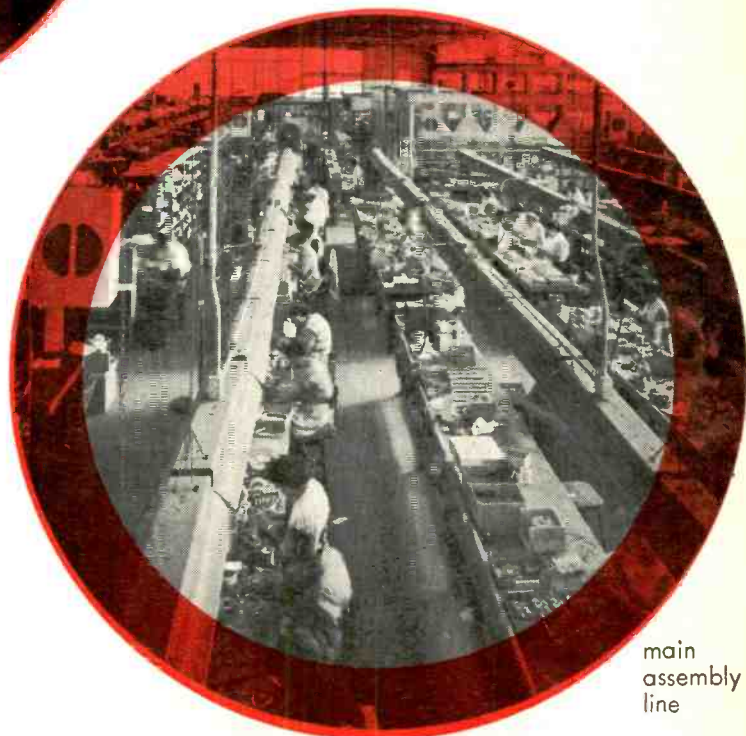

main
 assembly
 line

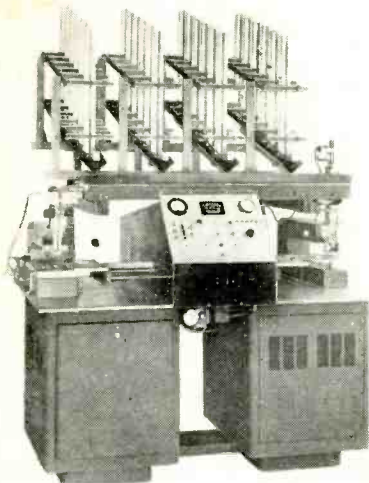

Drilling is done at the right and insertion of components at the left, under step-by-step control of punched paper tape in left-hand base cabinet of Design Tool Corp's Auto-Board. Hoppers at top, holding 24 different values of axial-lead components, release components one at a time as called for by tape

lation on all parts of the exhibit floor.

► **Rumor and Fact**—Multistation automatic assembly machines are running a poor second to women on tv assembly lines, with the result that some machines are gathering dust in odd corners of plants, according to convention-floor gossip. Dark horse is the more complex but more flexible single-station machine which puts in one part after another under control of punched tape.

Prototype of one such machine was actually running in Design Tool Corp.'s booth. Under control of easily punched paper tape, this robot drills required holes one after another in one board while inserting parts in a previously drilled board. A tiny belt conveyor brings axial-lead components to the insertion head from 24 hoppers each having a release solenoid controlled by the tape. Loading and unloading of boards are manual, but board positioning is entirely automatic. Changeover to new board design is achieved simply by putting in new paper tape, since 24 different values of components can take care of most board requirements.

A machine similar to this one but guided by punched cards rather

than tape (ELECTRONICS, p 19, Aug. 20, 1957), is now in actual operation, with a market version being readied for a price tag in the \$100,000 range. It uses belted reels of components in place of hoppers, all feeding a single insertion head.

Still another machine of the flexible single-station type is rumored to be nearing completion behind locked doors in a midwestern research lab, under a development contract with an as-yet unknown manufacturer.

► **Signal Corps Role**—All of these new machines are no doubt based

in large part on experience acquired by GE in building ACAS for the Signal Corps, even though this granddaddy of the centralized-brain assembly machines now rests idly in the firm's Utica plant. Industry has thus taken up on its own the campaign by the military for automatic production equipment that could be set up and changed over within minutes to meet changing military needs in an emergency. Such fast changeover is needed when hundreds of different boards must be made for a missile control computer.

(Continued on page 12)

Business Briefs

► **Litton Industries**, Beverly Hills, Calif. and **Aircraft Radio**, Boonton, N. J., announces merger plans. Under the proposed agreement, subject to stockholder approval, Aircraft Radio stockholders will be offered choice of six-tenths share of Litton common or 0.23 share of Litton \$100 par 5-percent cumulative preferred for each share of Aircraft Radio common. In September, Litton Industries announced plans to purchase Maryland Electronic Manufacturing of College Park, Md. Payment was to be made with Litton stock, but amounts were not disclosed

► **Standard Coil Products** overcomes past loss operations. Net profit for July and August was about \$160,000. Further increases are expected in future months. A net loss of nearly \$1.5 million was registered in 1956. Profit improvement reported due mainly to program to end loss in Standard's Tuner Division. Program included cutting overhead, expenses and salaries and finding new markets

► **F. C. Huyck & Sons** plans increased concentration on instruments, control devices and other products for industry. For this reason company sold its blanket and cloth plant in Vermont

► **Credit Union National Association (CUNA)** reports that employees of electronic firms recently organized six more credit unions to provide 4,100 members with low cost credit facilities. Electronics manufacturing groups now have 108 credit unions. New credit unions were organized at **Applied Electronics**, San Francisco, Calif.; **Antennavision Manufacturing and Engineering**, Phoenix, Ariz.; **Radio Television Products**, Grass Lake, Mich.; **Crosley-Avco**, Evandale, Ohio and **Philco Corp.**, Sandusky, Ohio. In addition, the National Electronic Federal Credit Union was organized at Malden, Mass.

Nominal Performance Characteristics of Typical SPRAGUE Magnetic Shift Registers

OPERATING FREQUENCY	0-25			0-100			0-200		
	Recommended (kc)			0-90			0-190		
Maximum (kc)	0-25			0-100			0-200		
Recommended (kc)	0-20			0-90			0-190		
VOLTAGE SIGNAL LEVEL	4	15	30	4	15	30	4	15	30
SHIFT PULSE									
Nominal Operating Current (ma)	160	160	160	140	200	200	220	220	220
Voltage Drop per Stage (v)	5.4	8.0	9.5	8.0	10.0	13.5	6.8	6.0	9.5
Duration (μ sec at $\frac{1}{2}$ amplitude)	7.0	6.5	5.8	2.0	2.0	2.5	1.2	1.2	1.2
Rise Time (μ sec)	1.8	1.8	1.8	0.8	0.8	0.8	0.3	0.3	0.3
Fall Time (μ sec)	0.9	1.8	0.9	0.8	0.8	0.8	0.3	0.3	0.3
Peak Pulse Power (watts)	.55	1.5	1.6	1.12	2.0	2.7	1.5	1.4	2.1
INPUT PULSE									
Amplitude (ma)	15	10	5	15	10	15	15	10	10
Duration (μ sec)	10	10	10	3	3	3	2	2	2
PARALLEL OUTPUT PULSE									
Amplitude (ma)	4	16	32	5	18	30	4.5	16	30
Ratio (min.)	10:1	10:1	10:1	10:1	10:1	10:1	8:1	8:1	8:1
Load Impedance (ohms, min.)	2000	6000	25,000	1800	8000	15,000	10,000	10,000	18,000
DIODE TYPE (or equivalent)	T-7	T-7	T-7	T-7	T-7	T-5	T-7	T-5	T-5
ENGINEERING DATA SHEET	9111	9113	9115	9121	9123	9125	9131	9133	9135

core-diode type magnetic shift register assemblies

... 100% pulse performance tested

Wherever you use Sprague Magnetic Shift Register Assemblies... in the air or on the ground... in counters for industrial controls or basic logic circuits for computers... chances are you'll be looking for uniformity and reliability. That's why Sprague uses truly reliable components throughout their construction. Why every core used is subjected to rigid switching tests before installation. And why every assembly is 100% pulse performance tested before shipment.

Packages matched to the application

assure long register life at minimum cost. Register assemblies for ground use are available in hermetically sealed corrosion-resistant metal cases with glass-to-metal solder-seal terminals for severe environmental conditions, or embedded in plastic for moderate environments. Special minimum volume airborne packages are ideal for limited space applications.

All standard packages are characterized by terminal spacing that simplifies external mounting of semi-conductor diodes, or they can be permanently

packaged as integral assembly components in Sprague special designs.

Single and multiple stage register assemblies are available with read and write provisions to meet most system requirements. Standard designs can easily be modified with additional windings to perform various logical operations.

For Data Sheets on core-diode type magnetic shift register assemblies, write the Technical Literature Section, Sprague Electric Company, 35 Marshall St., North Adams, Massachusetts.

SPRAGUE[®]
the mark of reliability

SPRAGUE COMPONENTS:

MAGNETIC COMPONENTS • TRANSISTORS • RESISTORS • CAPACITORS • INTERFERENCE FILTERS • PULSE NETWORKS • HIGH TEMPERATURE MAGNET WIRE • PRINTED CIRCUITS



BRAIN TUMOR detector, that uses a radioactive arsenic source, is one of the new electronic devices shown at the Massachusetts General Hospital this month when three major groups gather in Boston to hear . . .

Doctors Evaluating Electronics

Keynote of conference:
new medical concepts based on
a highly-developed technology

AN IMPORTANT annual conference, taking place in Boston this month (Nov. 6-8), is coming closer and closer to bridging the gaps between doctors, engineers and biologists. The major groups sponsoring this conclave: The Instrument Society of America, The American Institute of Electrical Engineers, The Boston Chapter of The Professional Group of Medical Electronics of the IRE and the Medical Physics Group of Boston, will see and hear about new devices that are exploring breakthroughs in medical electronics. But more than that, they have raised their sights on a new concept of medicine.

The tenth Annual Conference On Electrical Techniques in Medicine and Biology has planned specific sessions that will appraise electronic devices used to study nerve kinetics, blood flow and membrane potentials.

► **Problems**—Despite the great strides that have been made in medicine since the beginning of the second World War, unsolved problems in medicine are great and pressure on the doctor to get his work done is greater than it has been in the whole history of the medical profession. The demand for treatment is greater than hospital facilities will allow, despite the huge medical centers that have multiplied during our generation. There are just not enough skilled and properly trained doctors to take care of our demands. There are not enough hospital beds to accommodate patients. Labor costs are rising too, and the big problem here is to free skilled men and women of medicine from routine tasks so that they may better devote their skills and training to more complicated tasks.

► **New era**—Medicine has now reached the stage that can no longer get along without a technology that will handle the doctors work more efficiently. Up to very

recent times, progress in biological research has been accomplished by using methods and techniques that are comparable, in a way to the methods of production used during the early stages of the industrial revolution.

Up to recent years medicine hasn't had its share of the electronics technology because medicine has been small business, not able to afford the research necessary to develop medical electronics as it should be developed. But medicine is now growing slowly and surely into big business that is spending more and more electronics money for biological research.

Plane Maker Turns to Instruments

Circuit analyzer is first electronic product to be marketed by Republic Aviation

MILITARY aircraft manufacturers are looking beyond expanding missile business to replace lost plane sales.

Several months ago Republic Aviation began to market an electronic circuit analyzer. A number of other electronic test equipment items, now under development, are expected to be released for sale shortly.

Also, for years Republic has made many electronic test instruments for its own use. Until now, no efforts were made to produce for sale because of pressing aircraft orders.

► **Personnel**—The growth of the electronics tooling department illustrates the new emphasis on electronics at Republic. In three years it has grown from 12 to 124 members.

As this department does only development work and limited manufacturing, a separate electronics manufacturing department, and possibly a special electronics division, is in the offing.

Here's how the circuit analyzer works. Circuits are harnessed to

(Continued on page 14)

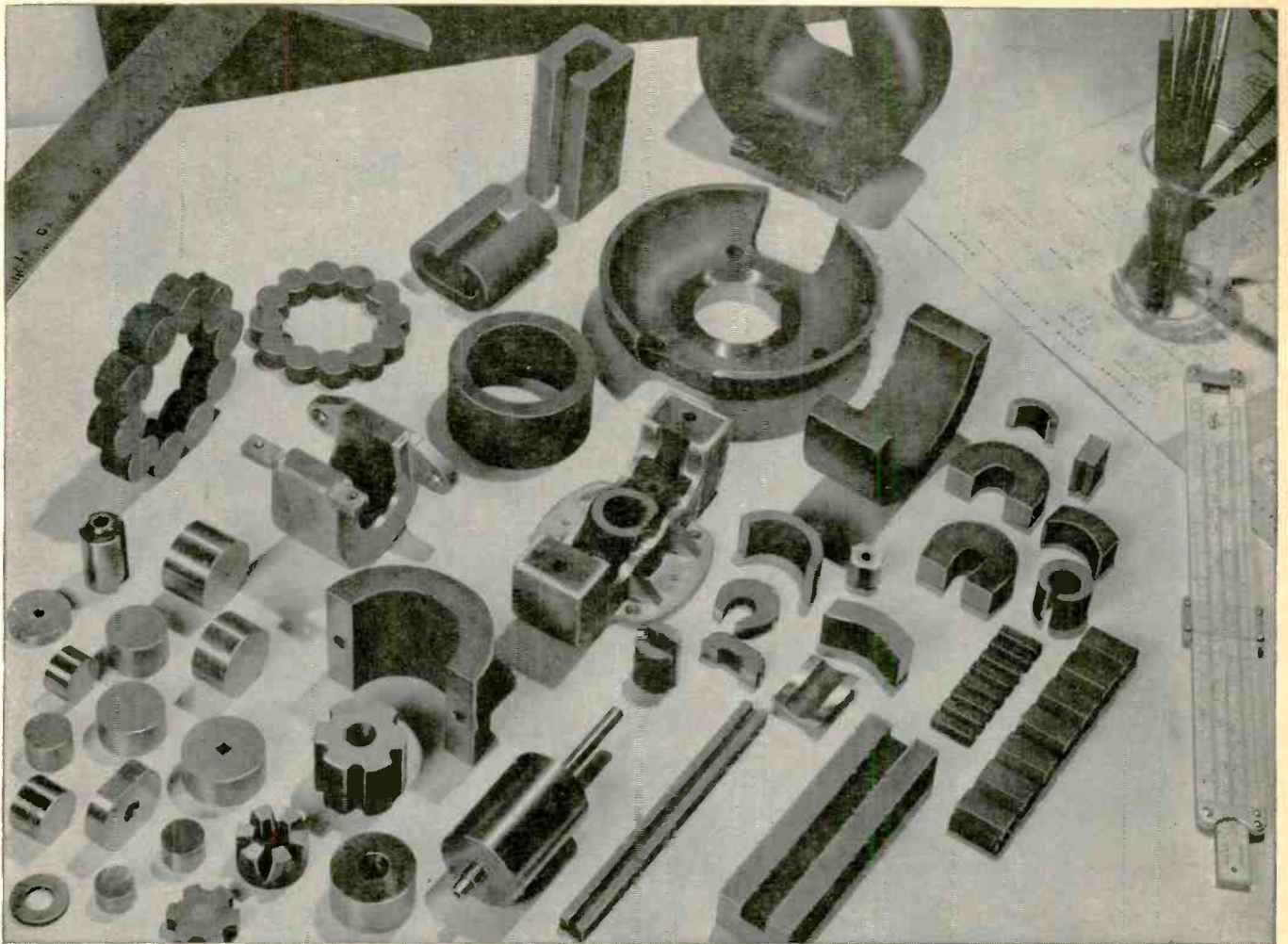

For Alnico Magnets—Stock or Special

Specify "ARNOLD"

Materials

Cast Alnico Magnets are most commonly made in Alnico V, VI or III. Sintered Alnico Magnets usually are made in Alnico II, V or VI. Special permanent magnet materials include Vicalloy, Cunico, and Cunife.

Engineering Data

**Write for your copy
BULLETIN GC-105 C**

Contains useful data on Alnico Magnets, their physical and magnetic properties. Also lists stock items and standard tolerances for cast and sintered magnets.

ADDRESS DEPT. E-711

Your best bet when looking for a source of Alnico magnets and assemblies is Arnold—producer of the most complete line of magnetic materials in the industry. Arnold can supply your need for any size or shape of Alnico magnet, as illustrated by the variety pictured above. Weights range from a few ounces to 75 pounds or more. Die-cast or sand-cast aluminum jackets, Celastic covers, etc., can be supplied as required. Complete assemblies are available with Permendur, steel or aluminum

bases, inserts and keepers as specified—magnetized and stabilized according to the requirements of the application.

A wide range of the more popular shapes and sizes of cast and sintered magnets are carried in stock at Arnold. Unsurpassed plant facilities make possible quick delivery of all special orders. • *Let us handle your magnetron, traveling wave tube and wave guide permanent magnet requirements, or any other magnetic material specification you may have.*

WSW 6875

THE ARNOLD ENGINEERING COMPANY



Main Office & Plant: Marengo, Illinois
Repath Pacific Division Plant: 641 East 61st Street, Los Angeles, Calif.

District Sales Offices:
 Boston: 200 Berkeley St. Los Angeles: 3450 Wilshire Blvd.
 New York: 350 Fifth Ave. Washington, D.C.: 1001-15th St., N.W.

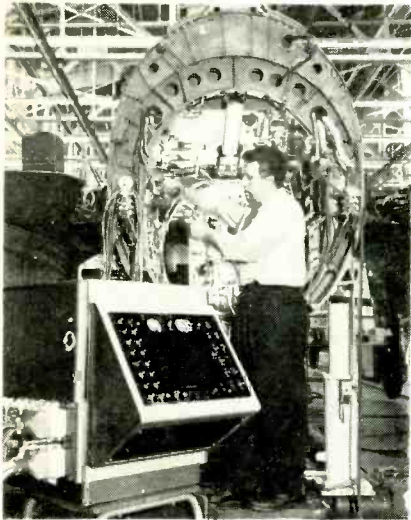

Circuits of F-85 interceptor being checked with 400-circuit automatic analyzer

the analyzer which first checks every circuit under test, lighting up to indicate malfunctioning ones. Then the instrument tells the nature of the trouble—short, ground open or reversed connection, weak insulation.

► **Capability**—The analyzer comes in five different models with capacity to test assemblies of 100, 200, 400, 800, and 1,200 circuits. The portable 100-circuit model can be used in the field.

One advantage of the analyzer is speed in circuit checking and resultant labor savings. If all circuits are ok they can be checked out in a few seconds on the small models and in a few minutes on the largest.

One circuit testing job used to take a minimum of 75 hours at Republic when a bell or light system for checking individual circuits was used. The same job, including setup time, now takes four hours. Furthermore, unskilled workers can quickly be taught to do the job.

Versatility has been achieved through use of removable program boards. If one analyzer is being used to check different circuits, separate program boards are wired for each circuit.

► **Market**—Aircraft, electronic and television, missile, computer and automotive manufacturers as well as ship operators have indicated interest in the analyzer.

Military Electronics

► **Development** and production of a 16-in. all-glass cathode-ray tube for military use is announced by Westinghouse. Equipment to house the tube, designated 16AKP7, is less complicated since there is no need to insulate the cone of the tube from its surroundings

► **Nearly 6,000 people** at Tglin Field, Fla. watched a heat-seeking Sidewinder pursue and destroy a 5-in. rocket fired from an F-100

► **Shock waves** that reach speeds of 100,000 mph and produce temperatures of higher than 100,000 degrees C are being created in a hydromagnetic shock tube built at Lockheed's research and development center, Palo Alto, Calif. To produce the wave, a large high-voltage charge is rapidly discharged from a bank of condensers at one end of the shock tube, creating a bubble of superheated gas. Expansion of the gas bubble produces a high-velocity and intensely luminous shock wave that flashes down the tube. The wave is boosted to the tremendous speeds and temperature by external magnetic fields which interact with the high-current discharge

► **Single spindle, five-axis profile milling machine** recently underwent performance and acceptance tests by USAF. The five axis machine in addition to conventional longitudinal, transverse and depth motion, can be tilted in both longitudinal and transverse directions plus numerous combinations of the two. All five motions are continuously and simultaneously controlled and synchronized by magnetic tape

Is This the Year for Stereo?

Despite strong public interest in stereo sound, many in hi-fi industry remain cautious

THE past few months have seen most of the major phonograph record companies giving the green light to full production of stereophonic magnetic sound tapes. They have also been marked by the first public demonstrations in a score of years of single-groove stereo disks. Upon hearing stereo for the first time, one observer at the New York hi-fi exhibit in October was heard to remark, "This is what I expected

hi-fi to be in the first place!"

► **Downbeat**—Despite the all-out support of the giants of the record industry, and in the face of consumer interest, many hi-fi manufacturers are bearish about stereo's future. Only about one-third of the exhibitors at the New York show are pushing stereo at all. Attitudes of the other range from cautious optimism to downright pessimism.

Many of them recall that stereo sound has been on the scene in one form or another for over two decades, but never caught on with

(Continued on page 16)

KÄHLE machines

for
faster,
more precise
semiconductor production

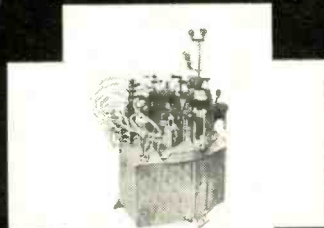

AUTOMATIC
DIODE BEADER #2719



CRYSTAL GROWER
#2901B

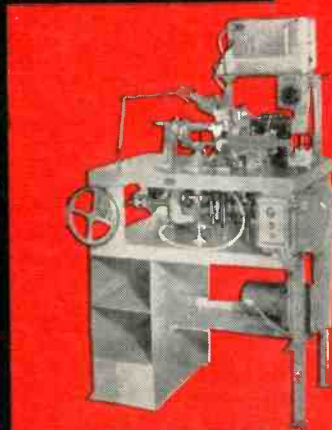

AUTOMATIC CAT WHISKER
WELDER #2981



AUTOMATIC
MICRO-MINIATURE
GLASS BODY MAKER
#2461

What makes Kahle machinery a standout among automated equipment for semiconductor and electron tube production? The most important reason is Kahle's craftsmanship — born of over 25 years design and manufacture of electronic production equipment. Secondly, every Kahle machine is a custom-designed unit with your particular production requirements in mind.

What makes Kahle machinery your best buy? The answer again is Kahle's diversified experience — experience that covers the design and manufacture of automatic and semi-automatic machines for every step of semiconductor production from glass cutting, lead beading, encapsulating, crystal growing, mounting and etching, cat whisker producing — to final sealing and testing.

What makes Kahle machinery your no-risk investment? Every machine is tested before your representative at the Kahle plant before shipment. No machine is permitted to be shipped before it receives your seal of approval.

Catalog sheets on the entire Kahle line are available in Kahle's latest file folder. Write for them today.

KÄHLE

ENGINEERING COMPANY

GENERAL OFFICES:
1310 SEVENTH STREET, NORTH BERGEN, N. J.

PLANTS:
SEVENTH STREET, NORTH BERGEN, N. J.
HUDSON AVE., UNION CITY, N. J.

DESIGNERS AND BUILDERS OF SPECIAL AUTOMATIC AND SEMI-AUTOMATIC EQUIPMENT FOR ALL INDUSTRIAL OPERATIONS

the public. Some cite the rather lukewarm results of the stereophonic promotion in motion pictures.

► **Upbeat**—At the annual convention of the Audio Engineering Society, however, which ran concurrently with the New York show, the tremendous interest in stereo was in evidence throughout the program. In addition to one afternoon and evening being devoted exclusively to the topic, stereo was alluded to in numerous other papers. Some of the subjects included stereo standards and duplication, stereo disks, three-speaker stereo using a phantom circuit, pseudo stereo, stereo

reverberation, three-channel stereo recording, stereocasting and stereo reproduction in the home. The minority of stereo proponents at the show claimed capacity crowds for all of their demonstrations, which in turn sparked the writing of orders from distributors and dealers. They point out further that one company which introduced stereo tape several years ago, has been making original masters in stereo ever since and has a huge supply of material in the vaults to meet expected demand. One of the more active independents now has 50 items in its tape line and expects to jump the number to 75 by the end of the year. This firm's ratio

of tape sales is reported to run about 90 percent stereo against about 10 percent monaural.

► **Platters**—Feeling in some quarters is that stereo can never reach the mass market with tape alone, and most disk manufacturers are engaged in research aimed at a stereo record. Several such systems developed in Europe have had a careful going over from American firms. Manufacturers have also indicated interest in a recently announced U. S. system. At least one company is known to have imported equipment for experimental use. A major record producer is reported to be developing another system.

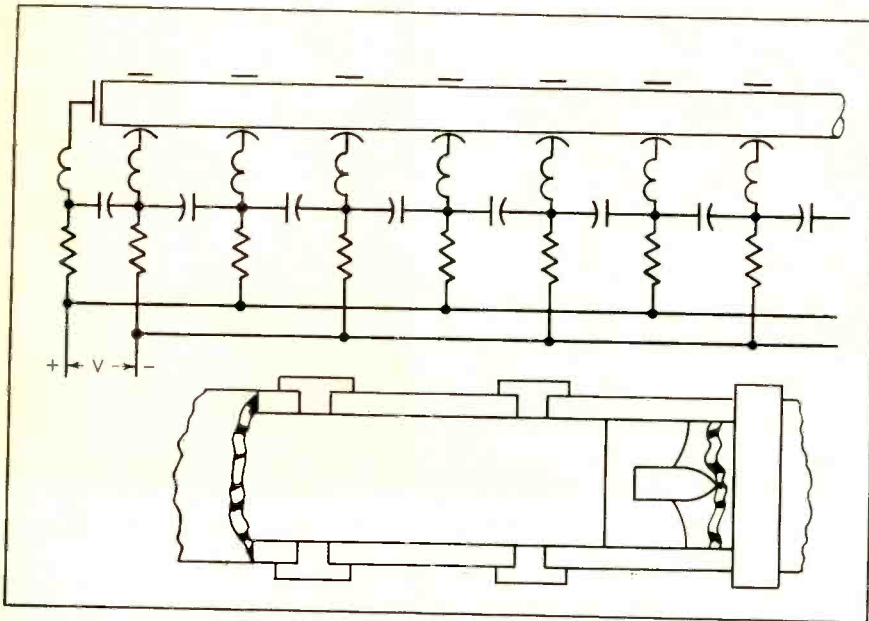

NEW electric gun accelerates projectiles to 30,000 feet a second as . . .

Missile Research Gets Hotter

Mass accelerators, shock guns test materials; wind tunnels simulate 15,000 F temperatures

SPEED-PRODUCED heat and materials problems are roadblocks which designers of missiles, rockets and supersonic aircraft must hurdle. Electric guns, shock tubes and super wind tunnels used in aerodynamic research produce a demand for instrumentation effective at ex-

treme temperatures and speeds.

► **Electric Gun**—One electric gun, designed at a GE missile nose testing lab, can accelerate a 20-gram projectile to 30,000 feet per second, twice the limit of explosive propellants.

Actually, the wind tunnel is an electrical-arc mass accelerator. It consists of a long gas-filled barrel with a series of ring electrodes

alternately charged positive and negative. As the projectile passes each electrode, the gas filling the barrel is ionized behind the projectile by an intense electrical discharge.

One researcher believes the mass accelerator could be used as a weapon because of its terrific speed. He noted that 30,000 feet per second is sufficient to break through gravity.

► **Shock tubes**—Some shock tubes are longer than 100 feet. They simulate high speed flight by bringing a powerful shock wave to the target. They require instrumentation and recording equipment able to operate in the millionth-second range. One built at Avco Research Lab produces a shock wave of 18,000 mph and a temperature of 15,000 F, sufficient to vaporize metal.

The wave is produced by placing a sturdy diaphragm between the shock tube and an explosion of compression chamber. When the diaphragm is broken, the shock wave is released into the low-pressure side.

► **Wind tunnel**—McDonnell Aircraft recently built a full-scale wind-tunnel facility which simulates conditions at 5,000 mph. It can test 15-foot-long structures at

(Continued on page 20)

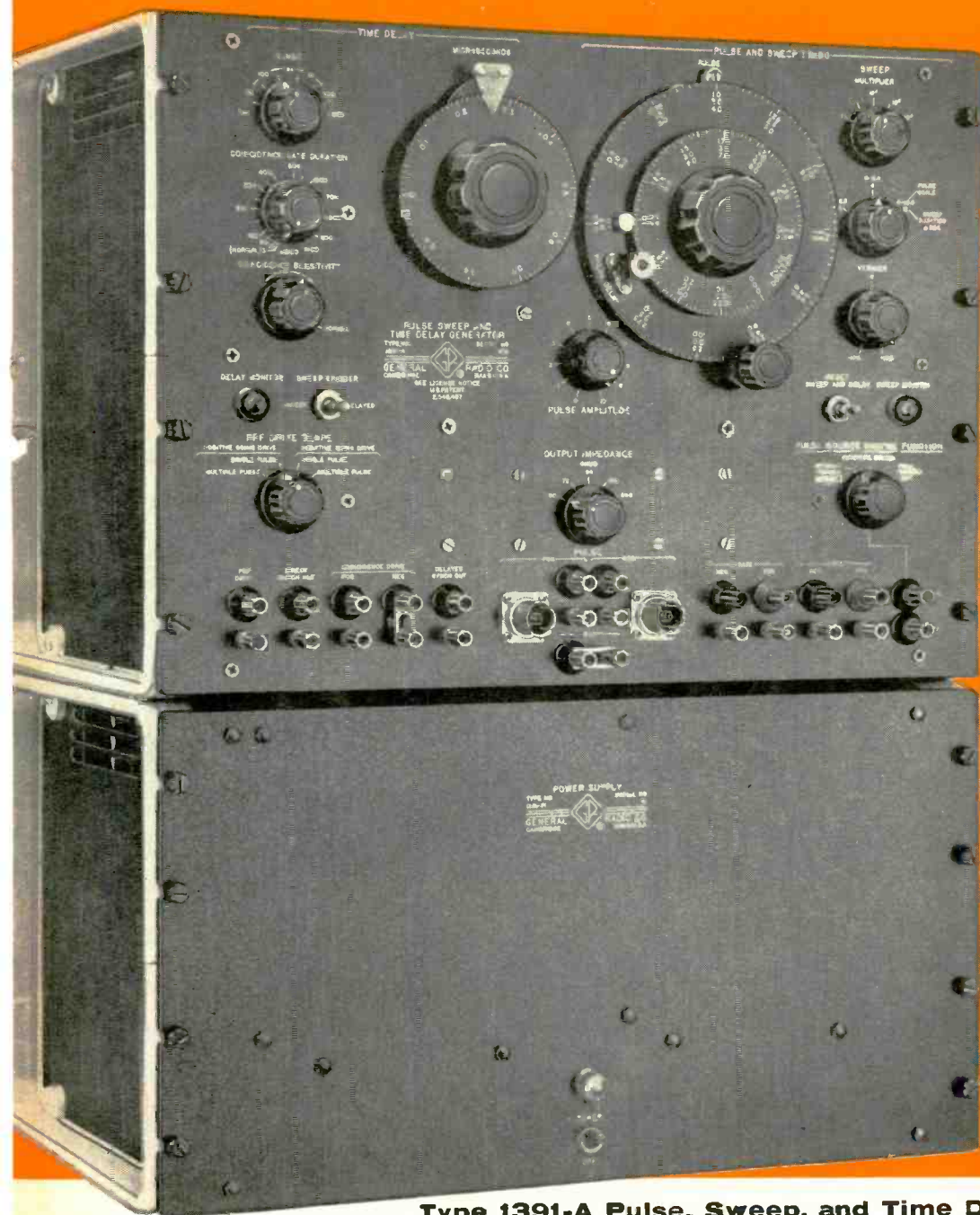

Basic Instrument for the Pulse Engineer

Type 1391-A Pulse, Sweep, and Time Delay Generator, \$1745

The Type 1391-A Pulse, Sweep, and Time-Delay Generator is the most versatile pulse package commercially available today. Pulse, sweep, and gate outputs (both positive and negative), triggers, delayed signals, and timing signals are all available at the front panel. Double pulsing (in three different ways) and the generation of pulse bursts are readily accomplished.

Performance specifications are excellent — they include extremely wide ranges of pulse duration (0.05 μ s to 10⁵ μ s), pulse-repetition frequency (dc to 250 kc), time delay (1 μ s to 1.1 sec), output impedance (50-600 Ω), and pulse amplitude (up to 90 volts).

Yet the basic pulse characteristics are outstanding: rise and decay times as low as 25 millimicroseconds, negligible overshoot, no ramp-off, no duty-ratio restrictions, and pulse jitter as low as one part in 50,000.

Write for our Pulse Bulletin which describes this instrument completely (it also describes our Unit Pulse Equipment).

GENERAL RADIO Company

275 Massachusetts Avenue, Cambridge 39, Mass., U.S.A.

Broad Avenue at Linden, Ridgefield, N. J. NEW YORK AREA 1000 N. Seward St. LOS ANGELES 38

8055 13th St., Silver Spring, Md. WASHINGTON, D. C.

1150 York Road, Abington, Pa. PHILADELPHIA

1182 Los Altos Ave., Los Altos, Calif. SAN FRANCISCO

6605 W North Ave., Oak Park, Ill. CHICAGO

Circle 72 Readers Service Card

The Type 1391-A Pulse, Sweep, and Time-Delay Generator takes external sine wave, square wave, pulse, or other cyclic voltage — uses this signal to synchronize its delay, sweep, and pulse circuits — and makes available at its various binding posts:

Direct-trigger pulse (or synchronizing pulse) timed by the input signal.

Delayed synchronizing pulse accurately adjustable in time by delay generator — to perform time selection, built-in coincidence circuitry permits timing of the delayed synchronizing pulse to be controlled by externally generated pulses fed into the instrument.

Push-pull sawtooth voltage of sufficient amplitude to be applied to the deflection plates of any oscilloscope for examining the generator's output pulses, or for use in driving auxiliary equipment.

Push-pull gating pulse having the same duration as the sweep.

Positive or negative pulses with excellent shape characteristics, continuously adjustable in duration, amplitude, and delay with respect to (a) the input trigger and (b) the sweep, at a variety of output impedances.

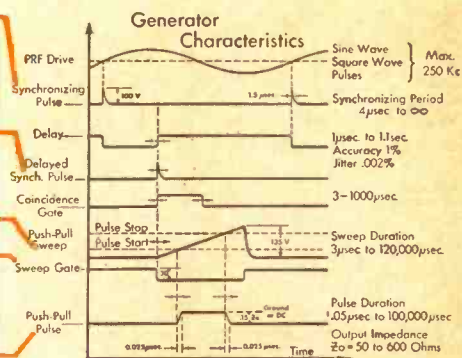

All G-R Products are now covered by a

2-Year Warranty



PERFORMANCE-PROVED

TRANSISTORS

for Superior Reliability... Superior Performance

Raytheon presents this full complement of both Silicon and Germanium PNP Transistors in the JETEC 30 package including new *RF and AF Types* and several types in an extremely small package.

All these Transistors are made by the Raytheon-perfected *fusion-alloy* process that assures superior electrical performance and supreme reliability; life tests aggregating over 20,000,000 transistor hours show *less than one open per 800,000 hours and no shorts.*

SILICON TRANSISTORS	Type	Case	V _{CE} max. volts	Beta ave.	I _{CO} ave. μa	I _{EO} ave. μa	r _b ave. ohms	r _c ave. kilohms	f _{αb} ave. Kc	Noise Factor max. db	Dissipation Coefficient	
											In Air	In Sink
											°C/mw	°C/mw
	2N327	A	-40	14	0.005	0.005	1300	900	300	30	0.43	0.25
	2N328	A	-30	25	0.005	0.005	1500	1000	350	30	0.43	0.25
	2N329	A	-20	50	0.005	0.005	1800	1250	600	30	0.43	0.25
	2N330	A	-20	18	0.005	0.005	1500	1000	500	15	0.43	0.25

COMPUTER TRANSISTORS	Type	Case	V _{CE} max. volts	f _{αb} ave. Mc	H _{FE1} ave. I _B = 1 ma V _{CE} = -0.25V	H _{FE2} ave. I _B = 10 ma V _{CE} = -0.35V	Rise Time* max. μsec	Dissipation Coefficient	
								In Air	In Sink
								°C/mw	°C/mw
	2N425	A	-20	4	30	18	1.0	0.4	0.18
	2N426	A	-18	6	40	24	0.55	0.4	0.18
	2N427	A	-15	11	55	30	0.44	0.4	0.18
	2N428	A	-12	17	80	40	0.33	0.4	0.18

*I_C = 50 ma; I_{B1} = 5 ma; R_L = 200 Ω; I_{B2} = 5 ma; Grounded Emitter Circuit

GENERAL PURPOSE AUDIO TRANSISTORS	Type	Case	V _{CE} max. volts	Beta ave. small signal	Power Gain Class A ave. db	I _{CO} ave. μa	Noise Factor ave. db	Dissipation Coefficient	
								In Air	In Sink
								°C/mw	°C/mw
	2N422	A	-20	90	40	6	6 max.	0.36	—
	2N464	A	-40	22	40	6	12	0.36	0.15
	2N465	A	-30	45	42	6	12	0.36	0.15
	2N466	A	-20	90	44	6	12	0.36	0.15
	2N467	A	-15	180	45	6	12	0.36	0.15
	2N130A	B	-40	22	40	6	12	0.59	—
	2N131A	B	-30	45	42	6	12	0.59	—
	2N132A	B	-20	90	44	6	12	0.59	—
	2N133A	B	-20	50	38	6	6 max.	0.59	—
	CK754	B	-10	300	45	6	—	0.59	—

Your Design is Better

Your Product performs Better

when you use RAYTHEON SEMICONDUCTORS

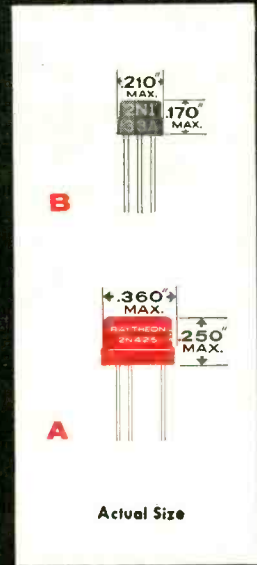
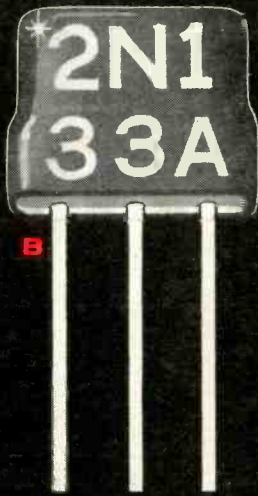

Write for Data Sheets
on individual types for
complete ratings and
test conditions.

GENERAL PURPOSE RADIO FREQUENCY TRANSISTORS	Type	Case	V_{CE} max. volts	$f_{\alpha b}$ ave. Mc	Beta ave.	c_{ob} ave. $\mu\mu f$	r_b " ave. ohms	Dissipation Coefficient	
								In Air	In Sink
								$^{\circ}C/mw$	$^{\circ}C/mw$
2N413	A	-18	2.5	25	12	70	0.4	0.18	
2N414	A	-15	6	40	12	80	0.4	0.18	
2N416	A	-12	10	60	12	90	0.4	0.18	
2N417	A	-10	20	80	12	100	0.4	0.18	

IF AND RF RADIO RECEIVER TRANSISTORS	Type	Case	Circuit Usage	V_{CE} max. volts	c_{ob} $\mu\mu f$	Gain db	Type	Case	Circuit Usage	V_{CE} max. volts	c_{ob} $\mu\mu f$	Gain db
2N482	A	IF	-12	12±2	31*	2N413A	A	IF	-18	12±2	31*	
2N483	A	IF	-12	12±2	35*	2N414A	A	IF	-15	12±2	35*	
2N484	A	IF	-10	12±2	39*	2N414	A	Conv.	-15	12 ave.	26‡	
2N485	A	Conv.	-12	12 ave.	26‡							
2N486	A	Conv.	-10	12 ave.	30‡							

*Maximum Available Gain @ 455 kc

‡Conversion Gain @ 1 Mc

AUDIO RADIO RECEIVER TRANSISTORS	Type	Case	Circuit Usage	Supply Voltage max. volts	Power Gain		Dissipation Coefficient	
					Class A	Class B	In Air	In Sink
					db	db	$^{\circ}C/mw$	$^{\circ}C/mw$
2N359	A	Output	-16	40*	37‡	0.36	0.15	
2N360	A	Output	-16	37*	34‡	0.36	0.15	
2N361	A	Output	-16	34*	31‡	0.36	0.15	
2N362	A	Driver	-16	41♦	—	0.36	—	
2N363	A	Driver	-16	37♦	—	0.36	—	

*@ 50 mw, 9 volt supply

‡@250 mw, 9 volt supply

♦@ 1 mw, 9 volt supply

All ratings taken at 25°C.

All types are hermetically sealed.

Unless otherwise indicated all data taken at $V_{CE} = -6$ volts, $I_c = 1.0$ mA



SEMICONDUCTOR DIVISION

Silicon and Germanium Diodes and Transistors • Silicon Rectifiers

Newton, Mass.: 55 Chapel St., Bldg 4-7500

New York: 589 Fifth Ave., Plaza 9-3900

Chicago: 9501 Grand Ave., Franklin Park, TUXedo 9-5400

Los Angeles: 5236 Santa Monica Blvd., NORmandy 5-4221

1,000 F and smaller pieces at 1,500 F, approximating 15,000 F and 5,300 mph at 90,000 feet altitude.

ARDC's new "Hot Shot" wind tunnel simulates flights of 11,000 mph at 15,000 F in order to investigate missile skin-cooling methods. Cornell Aeronautical Laboratory is planning an installation to realistically test aircraft and missiles in an airflow of 10,000 mph and

9,000 F, according to reports.

► **Flight tests**—Instrument and equipment makers, who provide flight-test engineers with tools, are pushing at high temperature, high-pressure barriers as well. Consolidated Electrodynamics, for example, recently announced a water-cooled pressure pickup adapter which allows the transducer to operate at 2,000 F.

capacitors loaded by the multiplier phototubes. The ratio is then recorded on the chart continuously.

Analysis of a metal alloy including six elements can be completed within 57 seconds, says Intec.

► **Advantages**—The Spectro-Lecteur is reported to have these other advantages:

- It successively records all the elements according to their own period of stability.

- Changeover from analysis of one alloy to another with a different base metal can be done within two minutes.

- Maintenance is easy because there are only two electronic circuits.

- Installation takes two days.

Analyzer Identifies Automatically

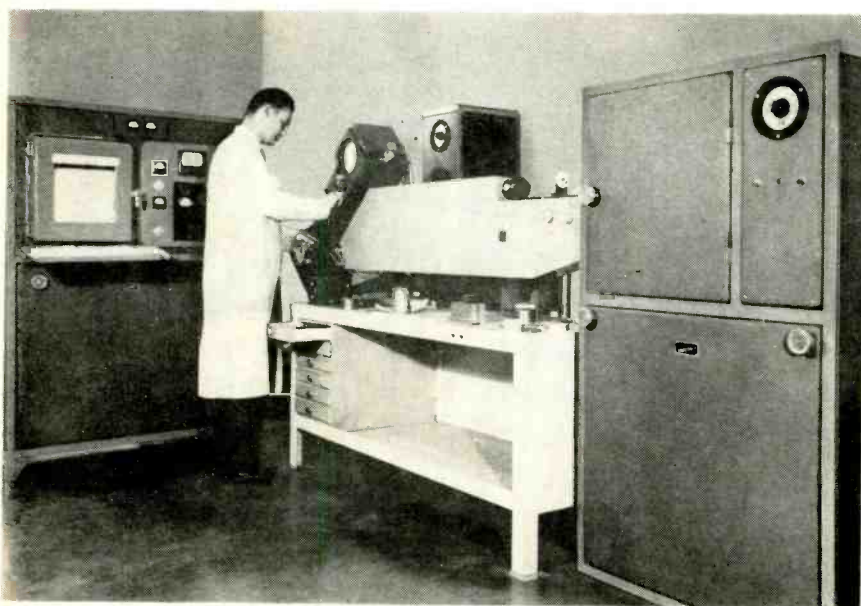

From left to right, metal analyzer consists of amplifier and recorder cabinet, direct reading head in front of automatic control cabinet, quartz spectrograph, and electrostatic-screening cabinet

Machine gives direct-reading of spectrum values obtained from electrical measurement

A FRENCH-DESIGNED metal analyzer that permits direct and instantaneous identification of specimens automatically is being introduced this week at the Metal Show in Chicago.

Unlike spectrographic analyzers which use as many multiplier phototubes as there are lines in the spectrum to be recorded, the Spectro-Lecteur uses only two multiplier phototubes, says Intercontinental Electronics Corp.

One multiplier phototube views a characteristic line of the basic

metal in the alloy. The other travels automatically along the focal plane of the spectrum, stopping at selected lines for a determined length of time according to a prearranged program.

► **Direct Reading**—In photographic-analysis, measurement of the density of the plate gives the value of the ratio of the characteristic spectrum line of the basic metal in the alloy to the spectrum of one of the other element contained in the alloy. However, in the Spectro-Lecteur's direct-reading method, this ratio is obtained through electrical measurement of potentials across the terminals of

Britain Pushes Airborne Controls

Exhibition features flight data systems, navigational aids and transistor devices

BRITAIN'S shift from aircraft to guided weapons is today spotlighting control components. This means the British electronics industry is now playing a larger role in the manufacture of guided weapons than the aircraft industry.

So says Aubrey Jones, Minister of Supply, in commenting on the exhibits of control components at last month's exhibition of the Society of British Aircraft Constructors.

Typical exhibitors were Ferranti, English Electric, Plessey, Elliott Bros., Dowty Equipment, and H. M. Hobson, to name a few of the 400 firms that have been engaged in guided weapons development.

► **DIAN System**—One important navigation feature at the show was the integrated DIAN system introduced by Decca Navigation Co. of London. The system comprises the Decca Navigator System for short-range positioning; Decca long-

(Continued on page 22)

NEW T/PLOTTER CUTS VIBRATION TEST TIME 50% to 75%

Automatically Plots Detailed
Curves of Transmissibility



Immediate evaluation of system transmissibility is made possible by the new Barry-Inesco T/Plotter which automatically draws a continuous curve of transmissibility. The T/Plotter eliminates data processing and conversion, and ends laborious point-by-point recording, calculating, and curve plotting. And because the recorded curve is *continuous*, there is no danger of missing significant peaks through arbitrary choice of points in the plotted curve.

How it works

Vibration pickups on the shaketable and on the test specimen feed their a-c voltage outputs into identical amplifiers and rectifiers in separate channels of the T/Plotter. The instrument's servo system responds to the difference between the two voltages, which is a measure of transmissibility.

Fast scan over the entire frequency spectrum quickly shows resonance points, and slow scan provides detailed analysis of these resonances, (see curves below).

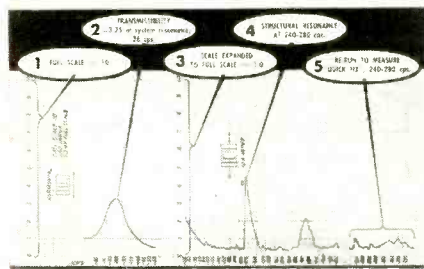

Measurement range

The T/Plotter can be set for full-scale ranges of 0.2, 1.0, 10, and 100. Any standard laboratory vibration pickup can be used. Frequency range is from 5 to 4000 cps. Accuracy is $\pm 2\%$ to 2000 cps, $\pm 2\frac{1}{2}\%$ above 2000 cps. Chart speed is variable from 6 to 960 inches per hour, in 16 steps.

Released time for laboratory equipment and personnel, resulting from the faster and more accurate measurements possible with the T/Plotter, expands the capacity of present lab facilities — without adding space, shakatables, control or metering apparatus to existing equipment. Write for Bulletin 57-04 that tells how you can cut vibration-test time 50 to 75%.

How to design for RELIABILITY UNDER SHOCK and VIBRATION

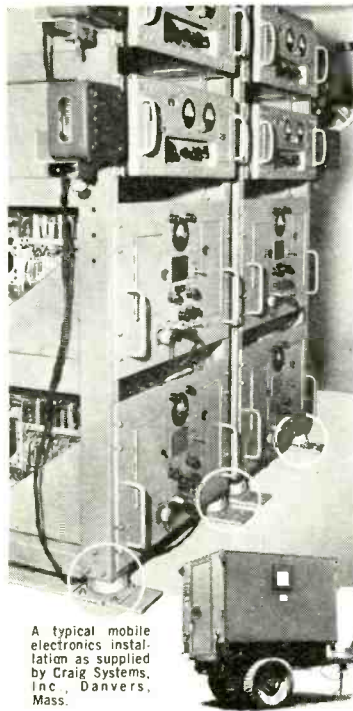

A typical mobile electronics installation as supplied by Craig Systems, Inc., Danvers, Mass.



To protect electronic gear against road shock during travel over rough terrain, Barry Cup-mounts supporting equipment racks of mobile air-traffic-control units combine effective protection against high-impact shock with efficient isolation of vibration frequencies above 45 cps. This isolates the structural resonances of the vehicle, with no amplification of vibration from tires and springs. In other applications, these mounts protect against the high transients of gun-fire shock. Details of load ratings, sizes, and characteristics — with useful data on choosing Cup-mounts — are yours in Barry Product Bulletin 56-02, free on request.

▶ FOR VEHICULAR SERVICE

LANDING-SHOCK CURVES

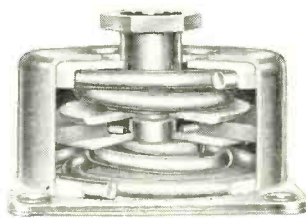
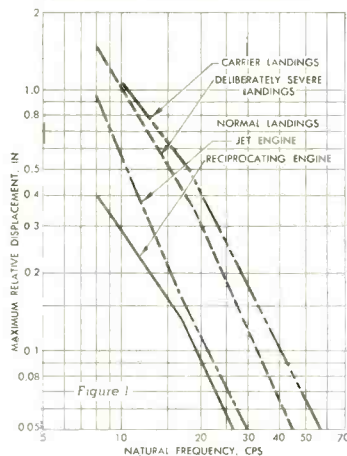

To protect sensitive electronic equipment in jet aircraft against landing shocks, while maintaining in-flight vibration isolation, mounts must be able to withstand the severe conditions indicated by the curves of Fig. 1, plotted from actual measured landing shocks. ALL-ANGL Barry Mounts, having natural frequencies above 25 cps, keep shock displacements within reasonable limits. Load-deflection curves, for this family of isolators that give protection under high thrust loads applied in any direction, are shown in Fig. 2. For complete performance data on ALL-ANGL Barry Mounts, write for Data Sheet 57-02.

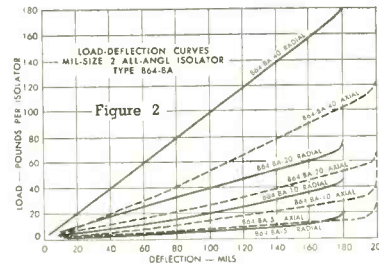

▶ FOR AIRCRAFT SERVICE

BARRY CONTROLS INCORPORATED

BARRY B MOUNT

SALES REPRESENTATIVES
IN ALL PRINCIPAL CITIES

707 PLEASANT STREET, WATERTOWN 72, MASSACHUSETTS

range navigation system and doppler navigation for positioning in areas where on ground facilities exist.

In the composite DIAN scheme, navigational information from all three systems is displayed on the same presentation unit. This reduces size, weight and complexity of doppler components. The Decca doppler system incorporates a wind memory system said to be more accurate than other systems based on storage of ground speed and drift.

Computer unit in the Decca system is completely transistorized with a-c transistor servos driving integrating motors and resolvers.

► **CADF System**—An improvement in vhf and uhf direction-finding systems is seen in Standard Telephones and Cables commutated automatic d-f system. In this system site errors are reduced by a factor of ten. Use of a wide baseline in the antenna system results in an improvement of three on a given suppression of horizontally polarized pickup in the Adcock d-f system.

The CADF system consists of 18 omnidirectional antennas operating either between 100-156 mc or 225-400 mc and placed uniformly about the circumference of a 45-ft metal counterpoise with a reference unipole antenna mounted in the center.

Output of each antenna is successively switched by diode switches at 30 times a second to one receiver, while output of the reference antenna is connected to a second receiver. Output of receiving system is mixed and demodulated; a sine wave is obtained with a frequency of the antenna switching cycle whose phase varies with azimuth. By comparing this with the reference signal in a phase comparison circuit, the bearing to an accuracy of 0.5 to 1.5 degrees is presented on a crt.

► **Airborne ssb**—An airborne ssb h-f transmitter/receiver is in prototype production by Mullard. Other companies are known to be working on such a system in Britain, but Mullard's 12-channel unit has successfully completed flight

trials which showed the 300-watt transmitter output to be equivalent in range to a dsb carrier of 2.5 kw.

The Mullard system uses controlled-carrier ssb modulation compared with usual American use of suppressed carrier.

► **Devices**—Here are some of the other featured devices at the British Aircraft Show:

Hydraulic jet control valve by Ferranti Ltd. operating at supply pressure of 1,500 lbs/sq in. control effected by two sets of replacable potted control coils which give a differential output pressure of 80 lbs/sq in./ma plus or minus 1 lb/sq in./ma in one model with a maximum of 700 lbs/sq in. In a second

model 140 lbs/sq in./ma is obtained with a maximum of 1,000 lbs/sq in. where only one set of coils is used. In both models the hysteresis loop only results in a maximum deviation of 1.5 percent of maximum current.

Also by Ferranti—a 300 GM viscously damped shorted-turn accelerometer covering the range plus or minus 25 g with a sensitivity of 0.23v/g and a linearity of better than 2½ percent. It consists of a symmetrical laminated core. The center limb carries the energizing coil and the two outers the secondary coil. A shorted turn of copper which is the inertia mass is mounted on retaining springs.

(Continued on page 24)

FCC Actions

► **Allocates** 1,200 kc of spectrum space between 150.8 and 152.0 mc for use of the nongovernment land mobile service

► **Allows** Radio Corp. of Puerto Rico to build a radio-telephone station for communication with the Dominican Republic by tropospheric scatter

► **Permits** Western Union Telegraph to establish subscriber rates for class M full-descriptive service on football games of the National Professional Football League

► **Amends** tv assignment table moving channel 13 to Hibbing, Minn., and substituting channel 9 for channel 13 in Bemidji, Minn.

► **Grants** All-American Cables & Radio new license to land and operate two submarine cables connecting New York City with the Panama Canal Zone, with an intermediate landing at U. S. Government Reservation, Guantanamo, Cuba

► **Changes** Domestic Public Radio Service Rules to permit operation of microwave auxiliary stations at fixed points in addition to present mobile operation

► **Expresses** regret at the death of former FCC Commissioner and Chairman Wayne Coy, "whose contribution to the progress and development of electrical communication in our country is recognized by all"

► **Publishes** a 1,485-page report of the Network Broadcasting Study ordered by Congress in 1955. Report includes a recommendation that the Commission forbid any licensee's owning more than three vhf stations in the nation's top 25 markets

Announcing

THE ACQUISITION OF THE *Macson Company* BY *Elco Pacific*



The news is out—and it's good news! Elco Corporation's wholly-owned subsidiary, Elco Pacific, has acquired the Macson Company. Macson has for years manufactured heavy-duty electrical and audio cable connectors which were judged on quality and reliability for commercial and military use; and based on these considerations, Macson has established an enviable reputation. These connectors have found great acceptance in equipment used in such diverse classifications as . . .

- Audio and Hi Fi Equipment—where heavy-duty connectors are required
- Geo-Physical—waterproof heavy-duty power-connectors in oil-well drilling
- Computers—in power-supply equipment
- Motion Pictures—in heavy electrical light, sound, camera installations
- Power Supplies for Military Equipment of various natures
- Construction—electrical drill, compressor, etc. power equipment
- Trucking—in electrical cabling of trucks to trailers
- Electrical Power Supplies for any miscellaneous heavy-duty use

With the acquisition of Macson, Elco is adding this complete line of power and audio connectors to its own present line; and in addition, Macson's facilities will give Elco the opportunity of serving you on the West Coast with on-the-spot service which your rapidly expanding industrial area requires. Yes, Elco now covers the continent from East to West; and wherever you are, whoever you are . . . Elco stands ready to serve you better!

ELCO

PACIFIC, Macson Division, 3260 Motor Avenue, Los Angeles, Calif.

HOME OFFICE & PLANT, "M" Street below Erie Avenue, Philadelphia 24, Pa.

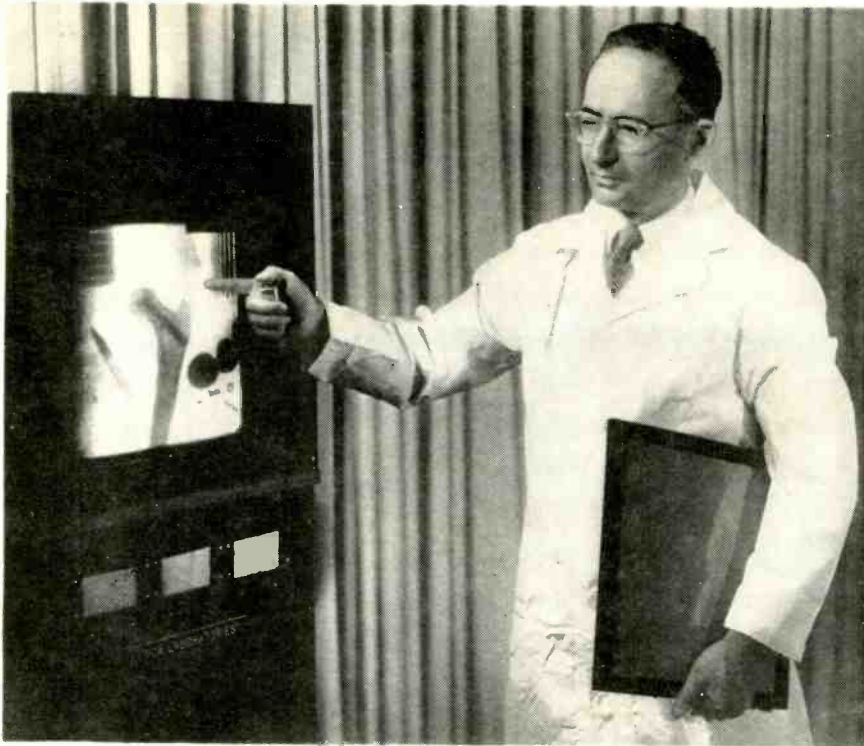

DEMONSTRATION gear reveals in lighted room specimens such as thigh bone with pin because . . .

Panel Amplifier Shows X-ray Image

Experimental thin screen can multiply x-ray brightness by 100 times, hold it for viewing

FOR SEVERAL YEARS medical electronics has been striving to perfect equipment that will give doctors a clearer view of what goes on inside the human body.

Now RCA announces an electronic amplifying panel which presents a bright x-ray image for up to 30 seconds after only a short exposure to the x-ray source. The thin screen reportedly multiplies by 100 times the brightness of certain medical x-ray images.

► **Advantages**—Researcher Benjamin Kazan (in picture) describes the amplifier as comparable in size and thickness to conventional fluoroscope screens, and with these other special capabilities:

- Greater visual contrast to allow easy viewing in rooms with moderate lighting.

- Reduction of the subject's x-ray

exposure by holding of a bright image.

- Erasing in less than a second to present a new image immediately.

- Expedient filming of the x-ray image from the amplifying panel.

► **Application**—A variety of applications may result from the experimental panel. For example, says Kazan, "a thin panel which presents a bright x-ray image after only a short exposure to the x-ray source and holds it up to half a minute, might be used to provide immediate visual information for the surgeon during certain types of operation.

"This might be done in such operations as the pinning of a hip, in which the location of the pin must be carefully determined by observation. At the present time, such checking during the operation is normally accomplished by recording the x-ray image on film, hurriedly developing the film outside, and rushing it back into the operat-

ing room."

He adds that x-ray amplification on a thin, large area panel can be easily viewed and manipulated, and is free of complex auxiliary equipment.

► **Materials**—Panel consists of a "sandwich" of two materials in adjoining layers between transparent electrodes. One layer—photoconductive powder—conducts current only when exposed to x-rays. The other—an electroluminescent material—emits a bright light when an electric current is passed through it.

Voltage is applied across the sandwich. When an x-ray pattern strikes the photoconductive layer, it acts as an electrical valve—allowing current to pass through to the electroluminescent layer, which emits light corresponding to the x-ray pattern.

Apparatus is entirely experimental now and is being demonstrated for the medical profession. Demonstration gear with 12-in. screen showing the effectiveness of amplifying panel would have to be adapted for actual operating room model. An amplifying screen that permits continuous viewing of motion with low-level x-rays is a long-range objective.

British Tv Reaches 97% Of Population

Radio Show closing marks new industry era: setmakers offer innovations to keep up demand

WHEN BRITAIN'S National Radio Show at Earl's Court, London, closed the doors on its 330,445 visitors at the end of a 10-day exhibition last month, it marked the coming of age of British television.

Coverage by the BBC now reaches 97 percent of Britain's 50-million population. The rival commercial ITV (Independent) service expects 85 percent saturation by 1958 and 90 percent by 1960.

This growth has brought demand

(Continued on page 26)

There's a
standard
PERKIN
model for
your every
need!

In addition to the 28 volt models featured at the right, the following units are also available:

OTHER 28 VOLT MODELS

Model	Volts	Amps	Reg.	AC Input (60 cps)	Ripple rms
28-5VFM	0-32 V	5	20% (24-32 V range)	115 V 1 phase	2%
28-10WX	24-32 V	10	± 1/2%	100-125 V 1 phase	1%
28-15VFM	0-32 V	15	20% (24-32 V range)	115 V 1 phase	3%
28-50WX	24-32 V	50	± 1/2%	230 V* 3 phase	1%
MR2432-200	24-32 V	200	± 1/2%	230 V* 3 phase	1%
MR2432-300	24-32 V	300	± 1/2%	230 V* 3 phase	1%
MR2432-500	24-32 V	500	± 1/2%	230 V* 3 phase	1%

* ± 10%. Also available in 460 V ± 10% AC input. Will be supplied with 230 V input unless otherwise specified.

6, 12, 115 VOLT (NOMINAL) MODELS

Model	Volts	Amps	Reg.	AC Input (60 cps)	Ripple rms
6 Volt	6-5WX	5	± 1%	95-130 V 1 phase	1%
	6-15WX	15	± 1%	95-130 V 1 phase	1%
	6-40WX	40	± 1%	95-130 V 1 phase	1%
12 Volt	12-15WX	15	± 1%	95-130 V 1 phase	1%
	115-5WX	5	± 1/2%	95-130 V 1 phase	1%
115 Volt	MR15125-5	5	± 1% †	95-130 V 1 phase	1% †
	6125-25**	25	1 1/2-4%	230/460 V 3 phase	5%

**Germanium Rectifier Unit † increases to 2% @ 15 V.

PERKIN...THE LEADER

in tubeless magnetic
amplifier regulated
DC POWER SUPPLIES

No Moving Parts • No Vibrating Contacts

IMMEDIATE
DELIVERY
FROM STOCK



Model MR532-15A

2-36 VOLTS @ 15 AMPS SPECIFICATIONS

Regulation: 5-32 Volt Range: ± 1/2%
2-5 Volt and 32-36 Volt Range: ± 2%

AC Input: 105-125 Volts, (for 2-32 V.DC), 110-125 V, (for 32-36 V.DC), 1 phase, 60 cps (8 amps)

Ripple: 1% rms max. (@ 36 volts and full load. Increases to 2% @ 2 volts and full load).

Remote Sensing • Vernier Control



Model M60V

0-32 VOLTS @ 25 AMPS SPECIFICATIONS

Regulation: ± 1% @ 28 Volts (Regulation increases to 2% over range of 24-32 volts; does not exceed 2 volts over 4-24 volt range. Not stabilized for AC line changes.)

AC Input: 115 Volts, 1 phase, 60 cps (12 amps).

Ripple: 1% rms (@ 32 volts and full load—2% rms max. @ any voltage above 4 volts).

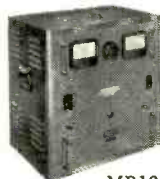

Model MR1040-30A

5-40 VOLTS @ 30 AMPS SPECIFICATIONS

Regulation: ± 1% (over entire 5-40 volt range)

AC Input: 100-130 Volts, 1 phase, 60 cps

Ripple: 1% rms



Model 28-30 WXM

24-32 VOLTS @ 30 AMPS SPECIFICATIONS

Regulation: ± 1/2%

AC Input: 100-125 Volts, 1 phase, 60 cps (20 amps). (Unit rated for DC output of 28 volts ± 10% for 95-130 volt input.)

Ripple: 1% rms



Model MR2432-100XA

24-32 VOLTS @ 100 AMPS SPECIFICATIONS

Regulation: ± 1/2%

AC Input: 208, 230 or 460 Volts, ± 10%, 3 phase, 60 cps (14, 12 and 6 amps respectively). 230 volt input will be supplied unless otherwise specified.

Ripple: 1% rms

NEW YORK AREA OFFICE:

Sales and Warehousing:
1060 Broad Street
Newark 2, New Jersey
Market 3-1454

NEW ENGLAND AREA OFFICE:

46 Amesbury
Lawrence, Massachusetts
Murdock 3-3252

CHICAGO AREA:

5218 W. Diversey Avenue
Chicago, Illinois
Palisade 5-6824

Wire factory collect for prices... Write for catalog.



PERKIN

LEADER IN TUBELESS MAGNETIC AMPLIFIER REGULATION

Representatives in Principal Cities

PERKIN ENGINEERING CORPORATION

345 KANSAS ST. • EL SEGUNDO, CALIFORNIA • PHONE: OREGON 8-7215

for tv sets to about 1.5 million a year.

► **Tubes**—Changes most evident at this year's show were in tube size and cabinet shape. Now the 17-in. tube is the most popular. But manufacturers are considering introducing 21-in. tubes with 90 or even 110-degree scanning.

Although there is industry speculation about the Gabor flat tube, it is generally felt that the industry's investments in plant for existing types will make it hard for such a revolutionary design to compete economically for many years.

► **Costs**—Keeness in cutting costs to the minimum is shown in the trend towards eliminating the tv fine tuner, incorporating afc circuits instead. In another line of attack, the radio industry is launching a "second tv set" campaign to sell 14-in. portables, and is providing f-m gear in many tv sets for about \$15 more.

F-m broadcasting has been a slow starter in Britain. BBC has 12 stations operating and 5 more under construction, which are designed to give 96 percent vhf f-m coverage,

Solid Supplies Power For Missile Guidance



Doughnut of black, plastic-like solid propellant will be used to drive gyroscopic devices to be produced by Sperry Gyroscope. The gyroscope it drives, on table, can be accelerated up to speeds of 50,000 rpm in 0.2 seconds

but the estimated audience is only 5 percent.

Manufacturers are pushing vhf, hoping to open up a new market. They have even put it in automobile radios. But at a price of \$150, compared with \$60-\$90 for regular auto sets, the going will be hard.

► **Transistors**—Britain is in the first stage of using transistors in home receivers, with only one U. K. company at present making power transistors. U. K. production of all transistors is estimated at about 1 million a year, compared with 80 million electron tubes. At the radio show, only about six transistorized products were displayed, all of these being portable radios or phonograph amplifiers.

Printed circuits are gaining wide commercial acceptance, with at least 30 sets at the show incorporating them.

Meetings Ahead

Nov. 2-10: 1957 International Congress of Measuring Instrumentation and Automation. Interkama, Dusseldorf, Germany.

Nov. 4-6: Third Annual Symposium on Aeronautical Communications, PGCS, Hotel Utica, Utica, N. Y.

Nov. 6-8: Tenth Annual Conference on Electronic Techniques in Medicine and Biology, ISA, AIEE, Sheraton-Plaza Hotel, Boston, Mass.

Nov. 11-13: Third Instrument Conference and Exhibit, PGI, Atlanta, Biltmore Hotel, Atlanta, Ga.

Nov. 11-13: Third Instrument Conference, IRE, PGI, Biltmore Hotel, Atlanta, Ga.

Nov. 11-13: 1957 Radio Fall Meeting, EIA (formerly RETMA) King Edward Hotel, Toronto, Canada.

Nov. 13-14: Mid-America Electronic Convention, IRE Municipal Auditorium, Kansas City, Mo.

Nov. 13-15: Assoc. of Tech Writers and Editors and Society of Tech Writers, Joint National

Convention, Hotel Statler, N. Y. C.

Nov. 13-15: Industrial Audio-Visual Exhibition, N. Y. Trade Center, N. Y. C.

Nov. 15-16: Northeast Electronics Research and Engineering Meeting, NEREM, Mechanics Bldg., Boston, Mass.

Nov. 18-20: Conference on Magnetism and Magnetic Materials, AIEE, APS, IRE, ONR, Sheraton-Park Hotel, Washington, D. C.

Dec. 4-5: Professional Group on Vehicular Communications, Annual Meeting, Statler Hotel, Washington, D. C.

Dec. 9-13: Eastern Joint Computer Conference, IRE, ACM, AIEE, Park Sheraton Hotel, Washington, D. C.

Dec. 18-19: Electronic Industries Conference (formerly RETMA) on Maintainability of Electronic Equipment, Univ. of Southern California, Los Angeles.

Jan. 6-8: Fourth National Symposium on Reliability and Quality Control, Hotel Statler, Washington, D. C.

Industry Shorts

► **Bus control**—London transport officials expect to test BESI this month. BESI is the Bus Electronic Scanning Installation that officials believe may "revolutionize the control of buses in congested cities." On one of London's busiest routes cameras will be located at scanning points. Each bus will have a panel of reflectors which will transmit a signal in code as it passes each scanner. This will give the bus number. Inspectors will tell where and when buses are bunching by tracking the progress of buses from one scanning point to another.

► **Moon tv**—Moscow Radio said a few months back that under favorable conditions a rocket could carry instruments to the moon within 5-10 years.

SWEEPING OSCILLATORS for RADAR and TELEMETERING IF's 1-1,200 mc by **KAY ELECTRIC**



Kay Vari-Sweep 860-A

The Kay sweeping oscillators are a line of high level lab and field test instruments designed for the alignment of radar and telemetering IF strips from 1 to 1,200 mc. The line offers a wide choice of precision-built units which are simple to operate, highly stable, and extremely flexible.

- Wide Range, Wide Sweep
- High Output
- Fundamental Frequency
- Constant Output (Fast-Acting AGC)
- Continuously Variable Centers
- Fixed, Crystal-Controlled Markers
- All Electronic Operation

Instrument	Cat. No.	Range	Sweep Width	RF Output	Markers	Price †
Vari-Sweep	860-A	2-220 mc (center)	Contin. Variable to 60% center freq. below 50 mc; 30 mc plus, above 50 mc.	1.0 V rms AGC'd, 70 ohms	None	\$695.
Vari-Sweep Model IF	866*	4-120 mc (center)		1.0 V rms AGC'd, 70 ohms	11 Fixed Crystals 1 Variable. Direct reading dial	\$950.
Vari-Sweep Model Radar	865*	10-145 mc (center)		1.0 V rms AGC'd, 70 ohms	11 Fixed Crystals 1 Variable. Direct reading dial	\$950.
Mega-Sweep	110-A**	50 kc-950 mc	50 kc-40 mc	100 mv at 50 ohms	None	\$495.
Rada-Sweep	380-A*	2 Switched bands 20-40 mc; 50-70 mc	2 Switched bands, Wide 20 mc, Nar. 3 mc	250 mv rms, 70 ohms	9 Fixed Crystals	\$395. (with 4 crystals)
Rada-Sweep Sr.	385*	1-260 (center)	70% of center to 100 mc; 60-70 mc from 100-250 mc	0.5 V rms AGC'd, 70 ohms	Up to 24 Fixed Crystals	\$545. (plus crystals)

**Other Mega-Sweeps to 1200 mc; and with Markers.

*Wider sweep widths, additional crystal markers available on special order.

† All prices F.O.B. Pine Brook, N. J.

For Literature and Detailed Specifications, Write:

KAY ELECTRIC COMPANY

14 Maple Avenue, Pine Brook, N. J.

Dept. E-11 CALDWELL 6-4000

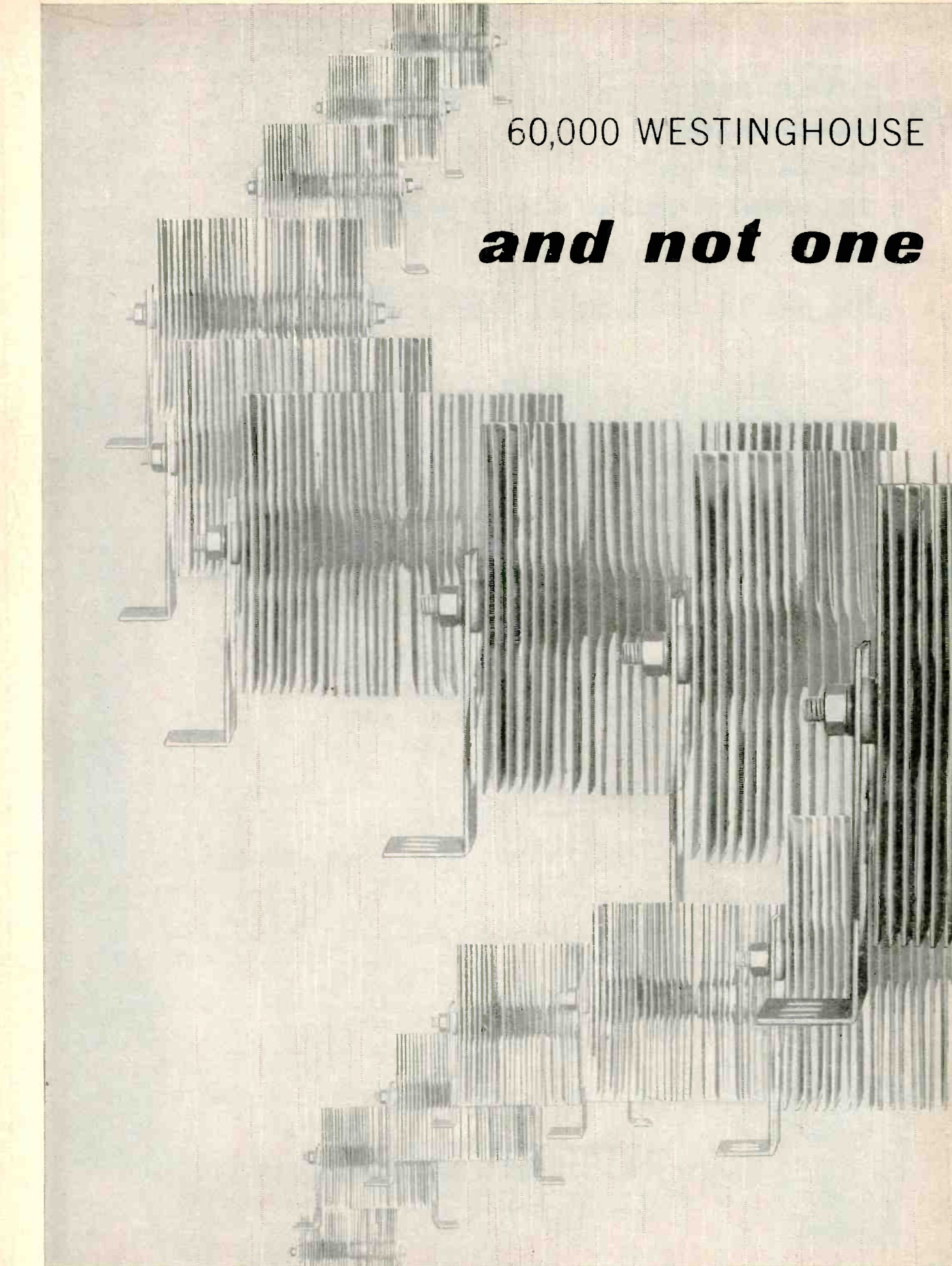

60,000 WESTINGHOUSE
and not one

RECTIFIERS INSTALLED FOR ONE CUSTOMER

case of field failure

The selenium rectifier stacks furnished for one Westinghouse customer have proved so successful in world-wide installations that they have standardized on Westinghouse units. In over three years, not one Westinghouse unit has been a field failure—or caused a failure of operation.

Extensive life tests prove that in 20,000 continuous hours of service, the change in forward voltage drop of Westinghouse rectifier cells is less than 5 percent. Reverse leakage actually decreases with use. This superior performance . . . with up to 90 percent conversion efficiency . . . is assured by the vacuum evaporation deposit process and carefully controlled manufacturing conditions in making Westinghouse selenium cells.

For complete design and application information, call your Westinghouse sales engineer. Or write Westinghouse Electric Corporation, P. O. Box 868, 3 Gateway Center, Pittsburgh 30, Pa.

J-22070

LOWEST FORWARD AGING RATE IN THE INDUSTRY

YOU CAN BE SURE...IF IT'S

Westinghouse

PHILCO...

in the Earth

Philco Surface Barrier Transistors Help Give First U.S. Satellite

As the first U.S. Satellite flashes through Outer Space in its orbit around the Earth, tiny Philco Surface Barrier Transistors will be helping to operate the complex scientific instruments it carries.

Project Vanguard, a major activity of the International Geophysical Year, is being undertaken for the purpose of gathering original data, vital to International Science as the first giant step in man's eventual conquest of the Universe.

While the Earth Satellite is orbiting in its trackless path, data on temperatures, radiations, micro-meteors and other phenomena will be collected and transmitted back to Earth.

Because of their proven reliability, low current requirements, extremely light weight and miniature size, Philco Surface Barrier Transistors have

helped solve the gigantic problems of reliability and miniaturization in electronic operation of these Satellite instruments.

Philco Surface Barrier transistors are literally *in the Vanguard* of modern electronics . . . helping make possible the success of Project Vanguard!

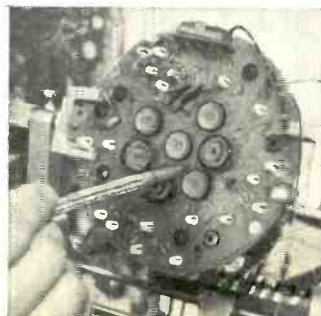

Telemetering pre-modulator circuit cards being assembled at U.S. Naval Research Laboratory, Washington, D.C.

Satellite



a "Voice"... at 18,000 MPH... From Its Orbit In Space!

Philco SBT's Still Operate After 126-Mile Plunge To Earth In Early Satellite Flight Test!

Circuit cards carrying Philco SBT's were recently sent aloft in a flight test at White Sands. The rocket attained an altitude of 126 miles... fell back to Earth (landing on a granite boulder). Although the housing was badly smashed... all Philco SBT's (except one... which was lost at point of sphere puncture) continued to operate with original performance characteristics!

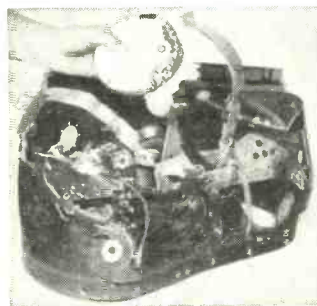

Smashed metal housing in which Philco Surface Barrier Transistors fell 126 miles during early Satellite vehicle flight test.

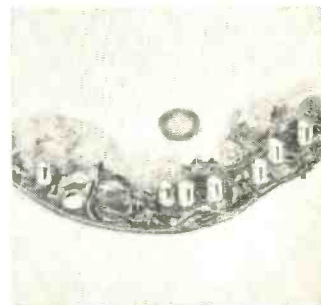

Close-up of actual circuit card, with plastic covering cut-away to show Philco SBT's... still intact and operable!

Write, wire or telephone for complete information on all Philco transistors.

PHILCO LANSDALE TUBE COMPANY DIVISION
LANSDALE, PENNSYLVANIA

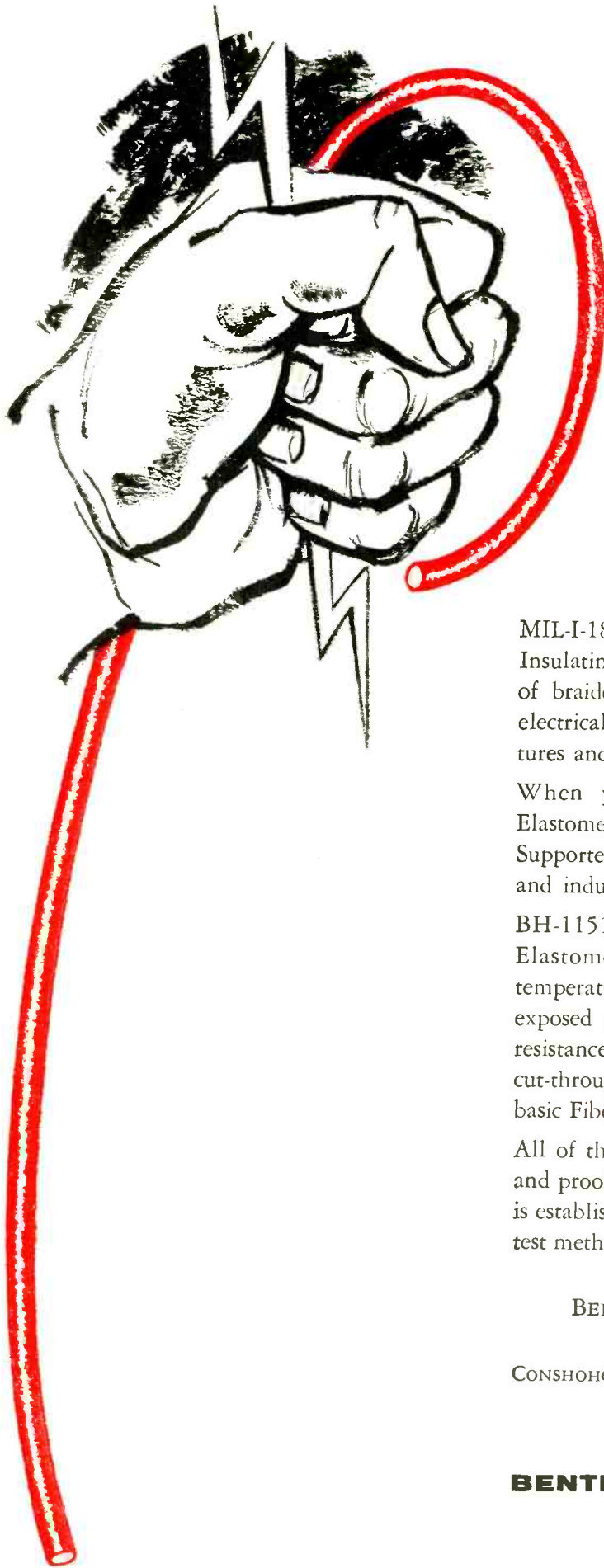

For all the stringent
requirements of
MIL-I-18057A
BH "1151"

MIL-I-18057A is a functional type test — for Class H Insulating Sleeving. It sets the standard for performance of braided Fiberglas Silicone Elastomeric sleeving in electrical insulating systems subjected to high temperatures and mechanical stress.

When you specify BH-1151 Fiberglas Silicone Elastomeric Sleeving, it meets these high standards. Supported by long record of service in both military and industrial applications.

BH-1151 combines the superior qualities of Silicone Elastomer — extreme low temperature and high temperature flexibility, resistance to degradation when exposed to high temperature, chemical inertness, and resistance to crazing — with the support, resistance to cut-through and dimensional stability offered by the basic Fiberglas braid.

All of these properties are required by MIL-I-18057A and proof of BH-1151's ability to meet these standards is established by data obtained in each of the prescribed test methods. These data sheets are available on request.

BENTLEY, HARRIS MANUFACTURING CO.

1100 Barclay St.

CONSHOHOCKEN 4, PA.

TELEPHONE: TAYLOR 8-0634

BENTLEY, HARRIS

Flexible
SLEEVINGS

Get out your pencil and . . .

Help yourself to

electronics' **READER SERVICE**

it's free—it's easy—it's for your convenience

NOW!

All Advertisements
New Products, and
New Literature are
numbered for your
convenience.

Each Advertisement, New Product, and New Literature item is numbered.

For more information simply . . .

- (1) Circle number on postpaid card below that corresponds to number at the bottom of Advertisement, or New Product item. Follow the same procedure if you desire New Literature.
- (2) Print your name, title, address, and firm name carefully. It is impossible to process cards that are not readable.

Correct additional postage **MUST** be added to cards for all **FOREIGN MAILINGS**

NOV
1-57
CARD
EXPIRES
FEB • 1ST

• **electronics** • **READER SERVICE CARD**

Please Print Carefully

NAME _____ POSITION _____

COMPANY _____

ADDRESS _____

Some Advertisements which cannot be numbered for the **READER SERVICE CARD** due to lack of space, must be indicated by writing the Advertiser's name in the space provided at the bottom of the



1	2	3	4	5	6	7	8	9	10	11	12	13	14	15	16	17	18	19	20
21	22	23	24	25	26	27	28	29	30	31	32	33	34	35	36	37	38	39	40
41	42	43	44	45	46	47	48	49	50	51	52	53	54	55	56	57	58	59	60
61	62	63	64	65	66	67	68	69	70	71	72	73	74	75	76	77	78	79	80
81	82	83	84	85	86	87	88	89	90	91	92	93	94	95	96	97	98	99	100
101	102	103	104	105	106	107	108	109	110	111	112	113	114	115	116	117	118	119	120
121	122	123	124	125	126	127	128	129	130	131	132	133	134	135	136	137	138	139	140
141	142	143	144	145	146	147	148	149	150	151	152	153	154	155	156	157	158	159	160
161	162	163	164	165	166	167	168	169	170	171	172	173	174	175	176	177	178	179	180
181	182	183	184	185	186	187	188	189	190	191	192	193	194	195	196	197	198	199	200
201	202	203	204	205	206	207	208	209	210	211	212	213	214	215	216	217	218	219	220
221	222	223	224	225	226	227	228	229	230	231	232	233	234	235	236	237	238	239	240
241	242	243	244	245	246	247	248	249	250	251	252	253	254	255	256	257	258	259	260
261	262	263	264	265	266	267	268	269	270	271	272	273	274	275	276	277	278	279	280
281	282	283	284	285	286	287	288	289	290	291	292	293	294	295	296	297	298	299	300
301	302	303	304	305	306	307	308	309	310	311	312	313	314	315	316	317	318	319	320
321	322	323	324	325	326	327	328	329	330	331	332	333	334	335	336	337	338	339	340
341	342	343	344	345	346	347	348	349	350	351	352	353	354	355	356	357	358	359	360
361	362	363	364	365	366	367	368	369	370	371	372	373	374	375	376	377	378	379	380
381	382	383	384	385	386	387	388	389	390	391	392	393	394	395	396	397	398	399	400
401	402	403	404	405	406	407	408	409	410	411	412	413	414	415	416	417	418	419	420
421	422	423	424	425	426	427	428	429	430	431	432	433	434	435	436	437	438	439	440
441	442	443	444	445	446	447	448	449	450	451	452	453	454	455	456	457	458	459	460
461	462	463	464	465	466	467	468	469	470	471	472	473	474	475	476	477	478	479	480
481	482	483	484	485	486	487	488	489	490	491	492	493	494	495	496	497	498	499	500
501	502	503	504	505	506	507	508	509	510	511	512	513	514	515	516	517	518	519	520
521	522	523	524	525	526	527	528	529	530	531	532	533	534	535	536	537	538	539	540
541	542	543	544	545	546	547	548	549	550	551	552	553	554	555	556	557	558	559	560
561	562	563	564	565	566	567	568	569	570	571	572	573	574	575	576	577	578	579	580
581	582	583	584	585	586	587	588	589	590	591	592	593	594	595	596	597	598	599	600

card . . .

INSIDE FRONT COVER

INSIDE BACK COVER

BACK COVER

NOW IN YOUR HANDS . . .

THE ALL NEW 1957 electronics BUYERS' GUIDE!

USE IT THROUGHOUT THE YEAR AS YOUR STANDARD REFERENCE SOURCE

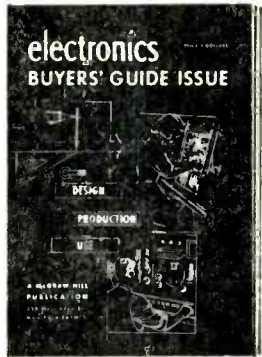

For 17 years . . .

THE BUYING GUIDE

For the electronics industry

As easy to use as the telephone book, your all new 1957 electronics BUYERS' GUIDE features:

COMPLETENESS: 1070 pages of products, manufacturers, trade names, manufacturers' representatives, and professional services.

ACCURACY: The entire electronic industry is questionnaired from scratch each year. For the 1957 GUIDE, there were 181 changes, 586 deletions (of the deletions, many were due to mergers and name changes), and 872 additions. Total

number of manufacturers increased to 4013 from 3727 in 1956. 87 new products were added in 1957 for a total of 1773.

USE: Whether you are concerned with the design, production, or use of electronic circuitry, turn to the listings of the **electronics BUYERS' GUIDE**. Here you will find the page numbers that refer you to catalog-type advertising, specially prepared to supplement the listings and give you the technical information you must have to specify and purchase electronic and allied products.



A McGraw-Hill Publication, 330 West 42nd Street, New York 36, N. Y.



FIRST CLASS
PERMIT NO. 64
(Sec. 34.9 P.L.&R)
NEW YORK, N. Y.

BUSINESS REPLY CARD
NO POSTAGE STAMP NECESSARY IF MAILED IN THE UNITED STATE

4¢ Postage Will Be Paid By

ELECTRONICS

Reader Service Dept.

330 West 42nd Street

New York 36, N. Y.

MIL-AC Custom Air Conditioning



Condition: Military Mobility

Mobile electronic systems can function under the most difficult environmental conditions (MIL-E-5272*), by using highly specialized mobile air conditioning equipment.

Custom air conditioning is our business at Ellis and Watts. For example, we recently designed and built MIL-AC air conditioning equipment for trailer-mounted F-11-F operational flight trainer simulators. They develop 10 tons of cooling capacity at 130° F., using no water. These units are only 24" wide and can be mounted anywhere to suit specific space requirements. This equipment is designed for an unusual 3-zone air distribution system to maintain constant temperature and humidity in computer, instructor and trainee sections—each with a different varying load condition.

MIL-AC units are self-contained, compact, lightweight, readily air transportable. They can be designed to cool, heat, humidify, dehumidify, filter, and can incorporate air-cooled or water-cooled condensers. Units are manually or automatically controlled. We are staffed with specialists who will analyze your requirements, submit a proposal, complete your installation promptly and to your complete satisfaction.

Write for helpful load calculating Nomograph and other technical data for use in making time-saving preliminary calculations.

*Military specification dealing with the following climatic and environmental conditions: Temperature, humidity, altitude, salt spray, vibration, fungus, sunshine, rain, sand and dust, explosive atmosphere, acceleration and shock.

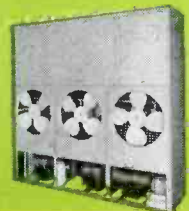

Typical MIL-AC Unit. MIL-AC configurations, features and functions to suit your specific requirements.

ELLIS AND WATTS PRODUCTS, INC.



P.O. Box 33, Cincinnati 36, Ohio.

Ellis and Watts also design and build custom air conditioners, liquid coolers and heaters, dehumidifiers, wave guide dehumidifiers, laboratory temperature and humidity control units.

Announcing the Raytheon

— a new type of broadband,
high power.....



**QK520
AMPLITRON
TYPICAL OPERATION (PULSED)**

ANODE VOLTAGE	40 kV
ANODE CURRENT	35 amps
PEAK POWER OUTPUT	800 kw
AVERAGE POWER OUTPUT	1200 watts
EFFICIENCY	55%
OPERATING BAND (± 1 db)	1225–1350 Mc
PEAK POWER INPUT	80 kw
PHASE STABILITY WITH ANODE CURRENT	1°/amp

The Amplitron is a new type of tube developed by Raytheon, capable of power amplification at microwave frequencies. Amplification is obtained over a broad range of frequencies with no mechanical or electrical adjustments required. This device is a derivative of the magnetron and retains many of its advantages—such as high operating efficiency, construction simplicity, small size, light weight, low operating voltage. Where efficiency counts in high-power systems, the broadband Amplitron has applications of major significance.

The Amplitron uses crossed electric and magnetic fields, a reentrant beam produced by a magnetron-type cathode, and a non-reentrant broadband circuit matched at either end to external circuits.

*AMPLITRON**

cross-field microwave amplifier

.....high efficiency

This amplifier has bandwidths of 10% with efficiencies of 50-70% over the entire band. Variations in anode current or voltage have little effect upon the total phase shift. This results in very low phase pushing and excellent reproduction of the input spectrum despite slow pulse rise time and ripple. Because the device has low insertion loss, duplexing may be accomplished at the input rather than the output of the final rf amplifier.

The Amplitron is another example of Raytheon's unequalled leadership in microwave tubes. A limited quantity of preliminary literature will be available shortly; to be sure of a copy, write now.



Excellence in Electronics

RAYTHEON MANUFACTURING COMPANY

Microwave and Power Tube Operations, Section PT-09

Waltham 54, Massachusetts

*Raytheon Trademark

Admiral®

KEEPS AERIAL CAMERAS STABLE AS A BILLIARD TABLE...

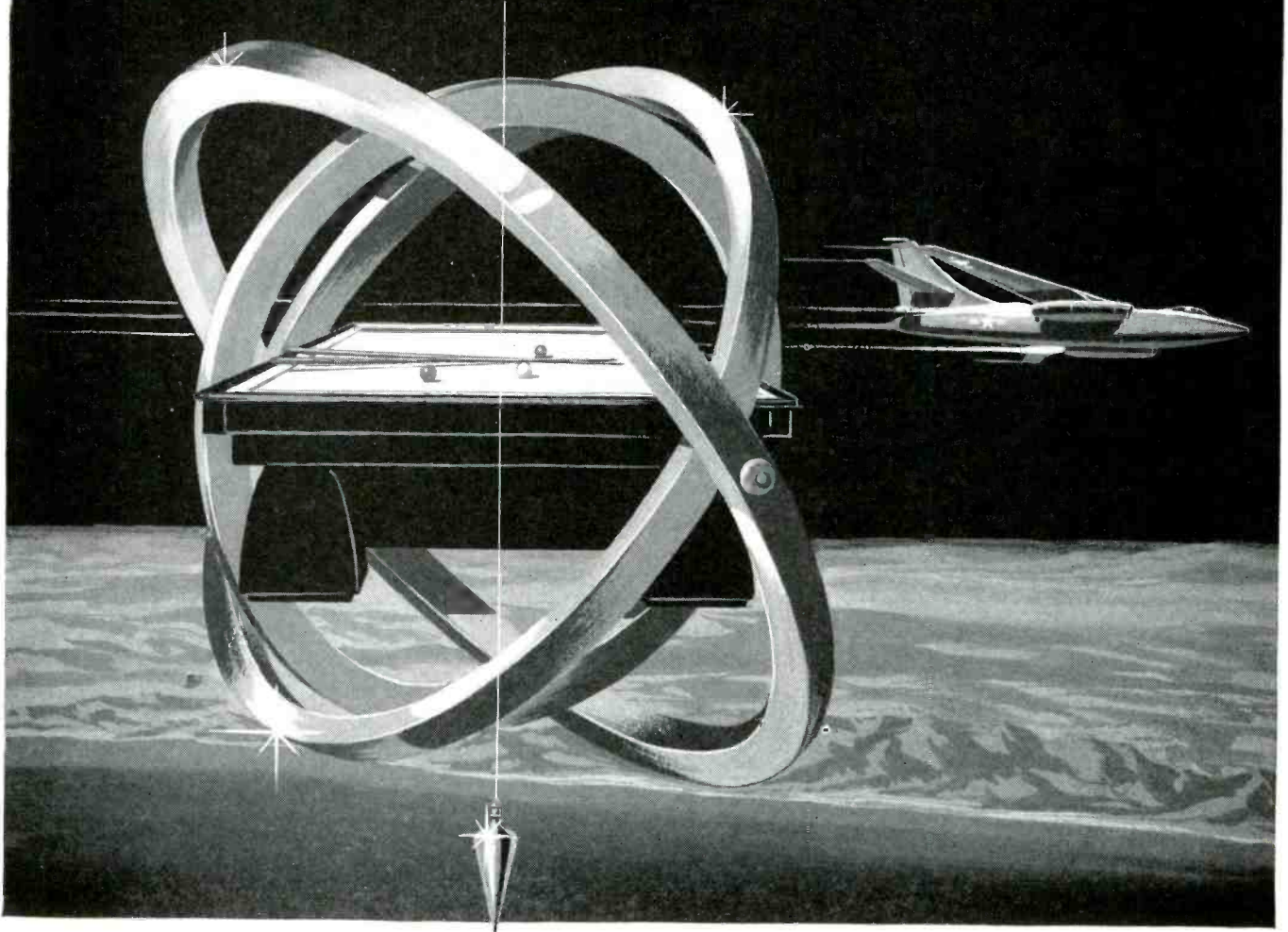

ADMIRAL'S PALO ALTO LABORATORY DEVELOPS EQUIPMENT FOR CAMERA STABILIZATION

The art of aerial photo-reconnaissance requires absolute camera stability to obtain the fine detail needed to discern small objects from great altitudes. Even with an automatic pilot in control, the plane itself is far too unstable for reconnaissance work, and additional stabilization is required.

Now Admiral has developed equipment that automatically compensates for the slightest deviations. Electronic signals from gyros are appropriately modified and distributed as needed to stabilize each of the various camera mounts. The accuracy of the gyro signals is fully reflected in the mechanical adjustments of each camera platform. Moreover, Admiral has applied subminiaturization techniques to reduce size and weight to half of the original requirement specifications.

This system was developed in Admiral's Palo Alto Laboratory by the Advanced Development Section, Government Laboratories Division. Complete information concerning the Laboratory's capabilities and current activities is available to qualified persons.

LOOK TO **Admiral** FOR

- RESEARCH
- DEVELOPMENT
- PRODUCTION

IN THE FIELDS OF: MILITARY TELEVISION
COMMUNICATIONS UHF AND VHF • RADAR
RADAR BEACONS AND IFF • RADIAC
TELEMETERING • DISTANCE MEASURING
MISSILE GUIDANCE • CODERS AND DECODERS
CONSTANT DELAY LINES • TEST EQUIPMENT
ELECTRONIC COUNTER MEASURES

ENGINEERS. The wide scope of work in progress at Admiral creates challenging opportunities in the field of your choice. Write Director of Engineering and Research, Admiral Corporation, Chicago 47, Illinois.

Admiral CORPORATION • GOVERNMENT LABORATORIES DIVISION • CHICAGO 47, ILLINOIS

Fast, convenient, dependable precision wave analyzers frequency-selective voltmeters



Sierra 121A Wave Analyzer

Sierra now offers exactly the instruments you need for wave analysis, wire carrier and microwave subcarrier applications.

Sierra 121A Wave Analyzer is a highly selective, double superheterodyne receiver covering frequencies from 15 KC to 500 KC and providing wave analysis data directly in voltage and dbm at 600 ohms. The instrument offers the selectivity required for use with new single sideband carrier systems.

Sierra 158A Wave Analyzer is similar but covers frequencies from 500 KC to 10 MC.

Both analyzers have high selectivity, accuracy of ± 2 db, spurious response at least 50 db down, and a signal-measurement range of 77.5 μ v to 97.5 volts. The instruments are supplied in cabinet mountings which are readily adaptable to relay rack mounting.

SPECIFICATIONS — SIERRA VOLTMETERS

Model	Frequency Range—kc	Selectivity		Accuracy		Direct Reading in dbm	
		Down 3db	Down 45db	Frequency	Measuring	Balanced	Unbalanced
101C	20-500	± 550 cps	± 2900 cps	Note A	± 3 db	Note D	600 ohms
103B†	3- 40	± 400 cps	± 3000 cps	± 0.5 kc	± 3 db	Note D	600 ohms
104A	5-150	± 300 cps	± 1500 cps	± 1 kc	± 3 db	Note D	600 ohms
108B	15-500	± 550 cps	± 2900 cps	± 3 kc Note B	± 2 db Note C	135 ohms Note D	600 ohms
114A	100-800	± 550 cps	± 2900 cps	Note A	± 3 db	Note D	600 ohms

All Sierra Carrier Frequency Voltmeters feature built-in calibration oscillators and circuits for level calibration, have aural monitoring jacks, and (except 103B) are furnished with Sierra Model 149A Precision Spiral Scale Dials.

† Contains carrier re-insertion oscillator for monitoring suppressed carrier systems. Furnished with planetary wave dial. Note A. Ranges from ± 2 KC at low end of dial to ± 3 KC at upper end. Note B. ± 1 KC in the 48 KC to 256 KC region. Note C. ± 1 db for $+30$ db to -40 db attenuator steps on 135 ohm balanced measurements. Note D. All models may be converted for 135 and 600 ohm balanced line measurements by convenient plug-in bridging transformer, Model 130D.

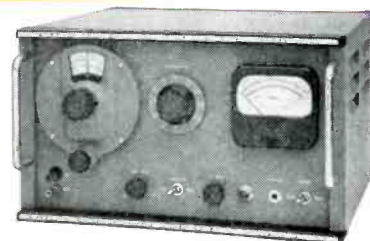

Sierra 101C Carrier Frequency Voltmeter

For carrier system and other field or laboratory work between 3 kc and 800 kc, Sierra offers 5 accurate, stable, tuned vacuum tube voltmeters. All are direct reading in voltage and dbm at 600 ohms from -80 dbm to $+42$ dbm.



Line Bridging Transformer

Model 130D Dual Impedance Line Bridging Transformer converts VTVM and wave analyzer inputs from single-ended to balanced operation. Covers 3 kc to 500 kc, bridges both 135 and 600 ohm balanced lines.

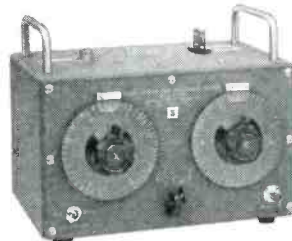

Impedance Meter, Line Fault Analyzer

Sierra 166 Impedance Meter (at left) measures impedance on high noise circuits, 30 kc to 300 kc; measures on "hot" lines through coupling capacitor. *Sierra 124 Line Fault Analyzer* pin-points shorts, opens or grounds on open wire lines. Direct reading, range $\frac{1}{2}$ to 200 miles, accuracy $\frac{1}{4}$ mile.

Data subject to change without notice.

sierra

Sierra Electronic Corporation

A Subsidiary of Philco Corporation

3885 Bohannon Drive Davenport 6-2060 Menlo Park, California, U.S.A.

Sales Representatives in Major Cities

Canada: Atlas Radio Corporation, Ltd., Toronto, Montreal, Vancouver, Winnipeg
Export: Frazar & Hansen, Ltd., San Francisco, New York, Los Angeles

4084

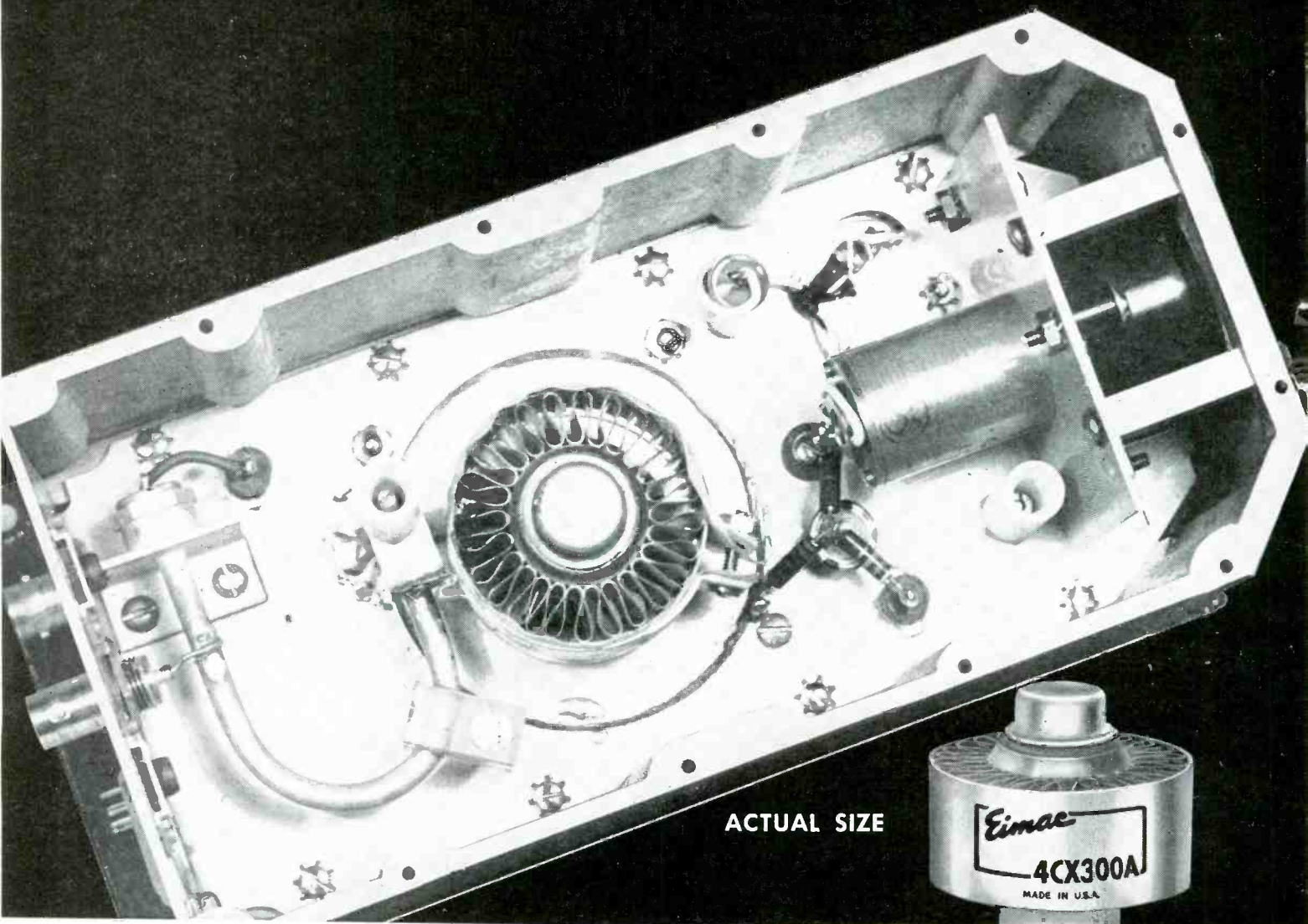

ACTUAL SIZE



**Compact, rugged RADIATION, INC.
airborne telemetering RF amplifier features
EIMAC ceramic 4CX300A tetrode**

Less than 1% amplitude modulation caused by mechanical excitation is noted at 100G, 6 milliseconds shocks or at 20G's vibration from 20-2000 cps in the new rugged Radiation, Inc., 50w telemetering RF amplifier. It is tunable through the 215-245 mc range to 70,000 feet altitude with the same outstanding dependability as at sea level. The amplifier is a space-saver, too, as illustrated in its actual size photo above.

To meet these environmental, electrical and physical specifications, exacting Radiation, Inc., engineers selected the

Eimac 4CX300A ceramic power tetrode for the final amplifier. This 300 watt tube conservatively generates the RF output of the Model A-3052-1 amplifier with only 2 watts driving power.

The 4CX300A offers the advantages of dependability and performance inherent in the extensive Eimac ceramic transmitting and receiving tube family.

EITEL-McCULLOUGH, INC.

SAN BRUNO · CALIFORNIA

Eimac First with ceramic tubes that can take it



**4CX300A RF power amplifier or oscillator
Class-C Telegraphy or FM Telephony**

MAXIMUM RATINGS

D-C Plate Voltage 2,500 max. volts
D-C Screen Voltage 300 max. volts
D-C Grid Voltage -250 max. volts

D-C Plate Current 250 max. ma
Plate Dissipation 300 max. watts
Screen Dissipation 12 max. watts
Grid Dissipation 2 max. watts

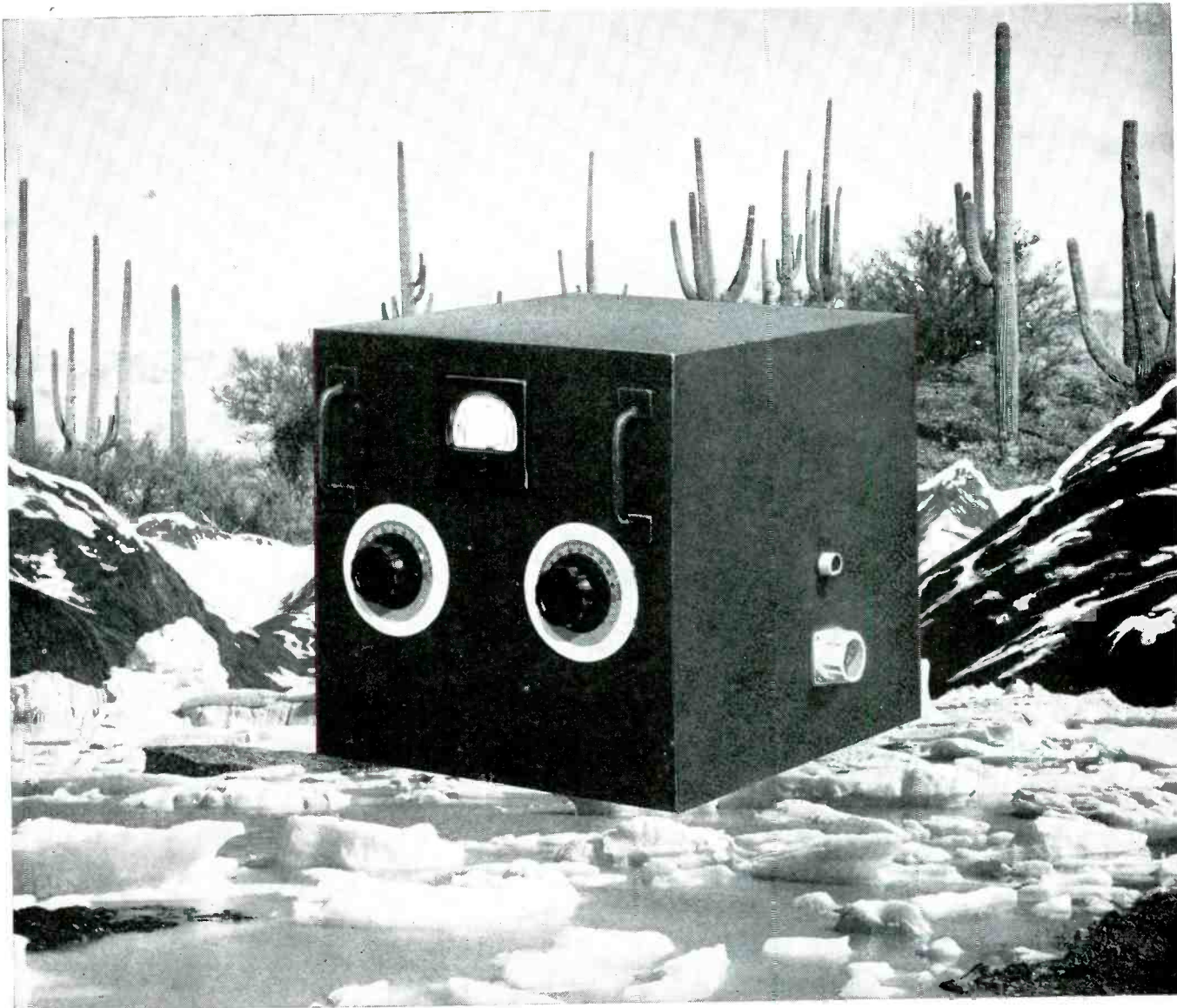

PROBLEMS: How to keep black-boxed equipment operating in sub-zero temperatures—and how to dissipate the box's heat when air cooling is impossible. Answer: Monsanto's OS-45, the most efficient coolant/dielectric from -65°F to 400°F .

Coolant/Dielectric for air-borne electronic equipment... usable from -65°F to 400°F : Monsanto's OS-45

If you are miniaturizing electronic equipment and need a coolant that

- is pumpable from -65°F to 400°F
- is an excellent heat-transfer medium
- has surprisingly good dielectric properties...

you'll find OS-45 tailored to your needs.

Monsanto's OS-45 is a coolant/dielectric that meets the most severe problems presented in "black boxing" electronic equipment for today's supersonic planes and tomorrow's missiles. It has an excellent service life and remains pumpable over the extreme temperature range of -65°F to 400°F .

A silicate ester, Monsanto's OS-45 is safe to use and is compatible with most materials used in electronic construction.

TO HELP YOU consider the pos-

sible uses of this new coolant/dielectric in miniaturization, we will be glad to send you Technical Bulletin O-123. Write, wire or mail coupon today.

MONSANTO PIONEERS NEW FLUIDS FOR THE MISSILE AGE

OS-45: Reg. U. S. Pat. Off.



Where Creative Chemistry Works Wonders for You

Organic Chemicals Division
MONSANTO CHEMICAL COMPANY
Aviation Fluids Dept. OS-5
800 North 12th Blvd., St. Louis 1, Mo.

Please send me Technical Bulletin O-123 which describes OS-45 completely.

NAME.....

COMPANY.....

ADDRESS.....



For your Magnetic Shielding Problems . . .

MUMETAL is the answer!



Write for your copy
"MAGNETIC MATERIALS"

This 32-page book contains valuable data on all Allegheny Ludlum magnetic materials, silicon steels and special electrical alloys. Illustrated in full color, includes essential information on properties, characteristics, applications, etc. Your copy gladly sent free on request.

ADDRESS DEPT. E-95

Mumetal shields will give instant relief to interference caused by extraneous magnetic fields. This material can cure many troubles—solve many a problem for you.

Use it where high permeability is required at low flux densities, such as in input and microphone transformers, hearing aid diaphragms, instruments, wire and tape recorders, etc. For properly heat treating Mumetal, we can also offer commercial hydrogen annealing facilities.

A fund of technical data on shields

and other applications for Allegheny Ludlum Mumetal is available—let us help with your problems.

In addition to Mumetal and other high-permeability alloys, we offer a range of magnetic and electrical alloys and steels that is unmatched in its completeness. Our services also include the most modern facilities for lamination fabrication and heat treatment. • Let us supply your requirements. *Allegheny Ludlum Steel Corporation, Oliver Building, Pittsburgh 22, Pa.*

STEELMAKERS to the Electrical Industry
Allegheny Ludlum

Warehouse stocks of AL Stainless Steels carried by all Ryerson plants





























WSW 6094

MILLIONS OF VARIABLE RESISTORS

for every commercial and military need

- A world-wide reputation . . . for economical uniform high quality assembly . . . on a precision mass production basis . . . by 1500 skilled, trained-on-the-job specialists . . . to your exact individual specification.
- 315,000 sq. ft. of plant area devoted to variable resistors.
- Exceptionally good delivery cycle . . . on both commercial and military orders.
- Write for complete 62 page catalog today.

Typical Bushing Mounted Controls	Typical Ear-Mounted Controls	Typical Printed Circuit Controls	Typical Military Controls
 <p>Miniaturized 3/8" diameter composition</p>	 <p>Molded shaft twist ear mounted 15/16" diameter composition</p>	 <p>Solder or clinch ear mounted 15/16" diameter composition with flush shaft</p>	 <p>Miniaturized 3/4" diameter 1/2 watt composition</p>
 <p>15/16" diameter composition</p>	 <p>Hollow shaft twist ear mounted 15/16" diameter composition for screwdriver adjustment</p>	 <p>Bushing mounted 15/16" diameter concentric tandem composition with SPST switch</p>	 <p>15/16" diameter 1 watt composition</p>
 <p>15/16" diameter composition with SPST switch</p>	 <p>Twist ear mounted 15/16" diameter composition with flattened shaft for push-on knobs</p>	 <p>Self-supporting snap-in mounted 15/16" diameter composition</p>	 <p>15/16" diameter composition with water-seal between shaft and bushing and bushing and panel</p>
 <p>1-1/8" diameter concentric tandem tone switch and composition variable resistor with SPST on-off switch</p>	 <p>Twist ear mounted 15/16" diameter composition with SPST switch</p>	 <p>Self-supporting snap-in bracket mounted 15/16" diameter composition with SPST switch</p>	 <p>1-1/8" diameter composition</p>
 <p>1-1/8" diameter composition with SPST switch</p>	 <p>Twist ear mounted 15/16" diameter preset tandem</p>	 <p>Self-supporting snap-in mounted compact 3-section multiple composition</p>	 <p>1-1/8" diameter 3 watt composition</p>
 <p>1-17/64" diameter 2 watt wirewound</p>	 <p>Miniaturized clinch ear mounted composition</p>	 <p>Miniaturized bushing mounted 3/4" diameter composition</p>	 <p>1-17/64" diameter 2 watt wirewound with locking type bushing</p>
 <p>1-17/32" diameter 4 watt wirewound</p>	 <p>Miniaturized clinch ear mounted composition with SPST switch</p>	<p>Terminals For Wire Wrapping</p>  <p>Bushing mounted 15/16" diameter composition with SPST switch.</p>	 <p>1-17/32" diameter 4 watt wirewound</p>

WEST COAST MANUFACTURERS: Many types of variable resistors now in production at our South Pasadena plant. Your coil, transformer and compression molding business also invited. Prompt delivery. Modern versatile equipment. L. A. phone Clinton 5-7186.

Variable resistors shown 1/3 actual size

WEST COAST SUBSIDIARY
Chicago Telephone of California, Inc.
105 Pasadena Avenue
South Pasadena, Calif.
L.A. Phone: Clinton 5-7186
TWX LA 1105

EAST COAST OFFICE
130 N. Broadway
Camden 2, New Jersey
Phone: Woodlawn 6-1668
TWX No. Camden NJ 380
Phila. Phone: Market 7-3129

SOUTHWESTERN U.S.A.
John A. Green Company
137 Parkhouse
Dallas 7, Texas
Phone: Riverside 3266

SOUTH AMERICA
Jose Luis Pontet
Buenos Aires, Argentina
Montevideo, Uruguay
Rio de Janeiro, Brazil
Sao Paulo, Brazil

OTHER EXPORT
Sylvan Ginsbury
8 West 40th Street
New York 18, New York
Phone: Pennsylvania 6-8239



ELKHART • INDIANA

The Exclusive Specialists in Precision Mass Production of Variable Resistors • Founded 1896

BURTON BROWNE ADVERTISING

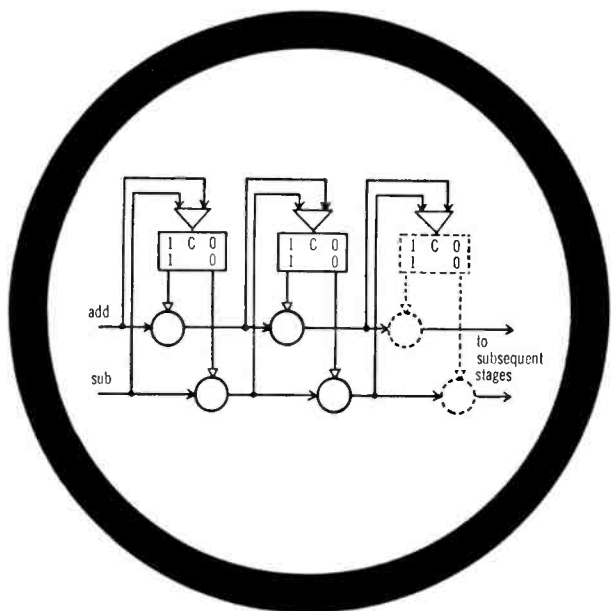

2 ways to make a bidirectional counter

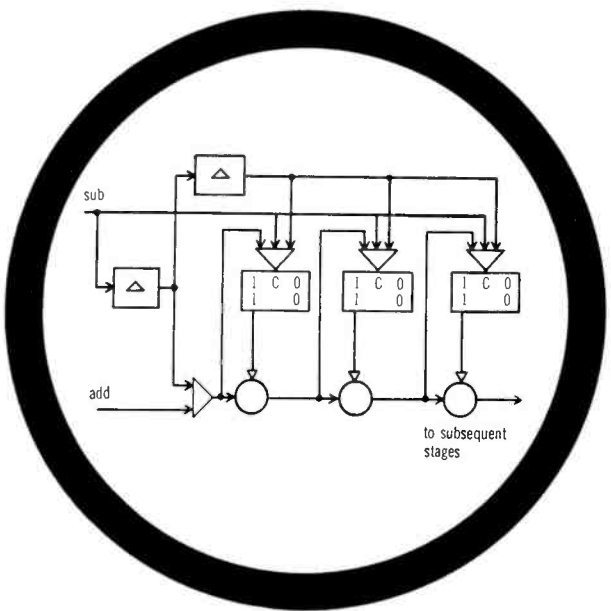

The block diagram is a two-dimensional representation of a designer's logical solution. Burroughs Pulse Control Equipment carries this representation one step further . . . into individually packaged hardware which permits the block diagram to be brought to life in a matter of minutes. Thus logical designers can concentrate on design, eliminate days of wasted breadboard time.

The two two-way counters illustrated are ideal examples of solutions readily proved with Burroughs Pulse Control Equipment. With either solution in block diagram form, the designer selects the proper Burroughs "blocks", sets them up in a standard rack, and interconnects them according to the flow lines in the diagram itself. Converting to the other counter design takes little more time than does redrawing the block diagram.

In addition to providing Pulse Control Equipment for proving solutions, Burroughs provides a complete problem solving facility ready to serve you. A call to Burroughs can bring you both a solution to your logical problem and a demonstration of how Pulse Control Equipment can speed their proof . . . at no cost to you. Or, write for Bulletin 236.

tools for engineers



PYLE *star-line* CONNECTORS

Assure long-lasting protection of vital connections under a wide range of extreme environmental conditions

Currently establishing itself as a performance leader in the missile systems field, Pyle-Star-Line connectors offer engineers an entirely new line of electrical connectors for universal military and industrial use.

With characteristics of construction and performance never before combined in compact, rugged, lightweight standardized connectors, they exceed NEC requirements and classes A, B, C and E of military specifications MIL C-5015C.

FEATURES

Tough, lightweight shell: Strength comparable to mild steel, yet weighs only 1/3 as much.

Anodic coating: Gives shell toughness of case-hardened steel. Takes up to 1800 volts to penetrate coating.

"Sandwich" insulation: Silicone laminate floats between two rigid discs. Silicone disc absorbs shock, lets contacts align themselves freely; rigid discs impart just the right amount of restraint. Gives all advantages of both flexible and rigid mountings.

Chamber sealing: Silicone insulation disc positively and completely prevents water, gas, moisture or dust from passing into shell.

Wide range of pin and socket configurations: Configurations from 2 to 100 poles available. Within each form size all inserts are interchangeable and reversible.



Environmental Limits of Pyle-Star-Line connectors	
Temperature	-80 F. to 225 F.
Pressure	300 PSI External, 200 PSI Internal
Chemical Resistance	Most acids, most alkalis, oil
Corrosion Resistance	Salt Spray: 300 days without failure
Dust Resistance	Exceed requirements of MIL C-5015C
Shock Resistance	50G Minimum
Vibration	Exceed 20G to Method II of Mil C-5015C
Humidity & Moisture Resistance	Exceed Class E, Spec. of Mil C-5015C
Air Leakage	Meet Class E Spec. of Mil C-5015C

Write today for complete specifications.

the **PYLE-NATIONAL** company



Where Quality is Traditional

1330 North Kostner Avenue, Chicago 51, Illinois

District Offices and Representatives in Principal Cities of the United States
CONDUIT FITTINGS • CIRCUIT CONTROLS • LIGHTING EQUIPMENT



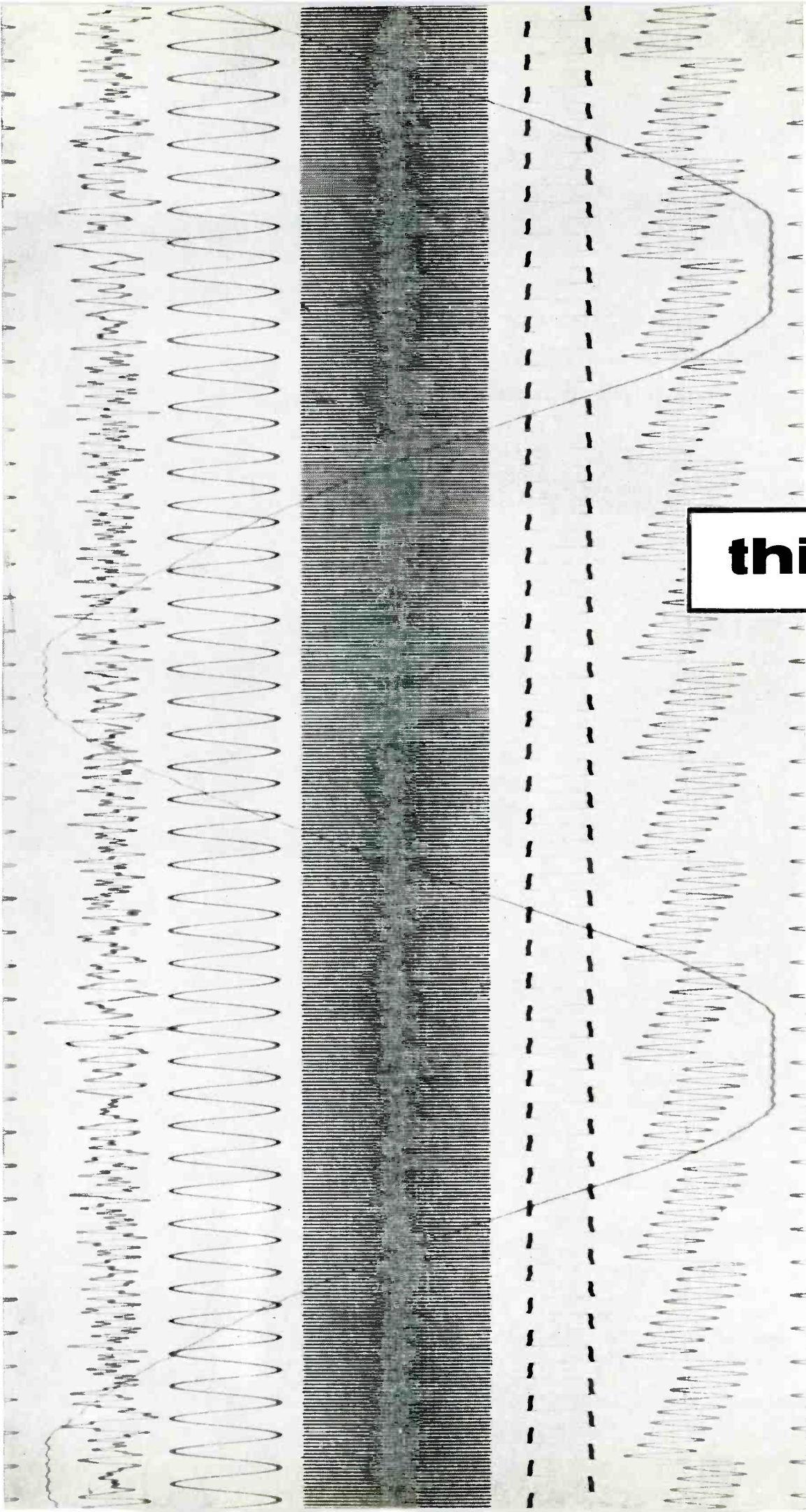

this is



This Visicorder Oscillograph record* is a symbol of the leadership that is typical of Honeywell engineering. In laboratories all over the world the Visicorder's instantly-readable direct records are showing the way to new advances in rocketry, control, computing, product design and component test and in nuclear research.

*reproduced actual size, unretouched

The Model 906 Visicorder is years ahead of the trend. It is the first oscillograph that combines the convenience of direct recording with the high frequencies and sensitivities of photographic-type instruments. The Visicorder alone among oscillographs lets you monitor high-speed variables as they go on the record.

a record of leadership

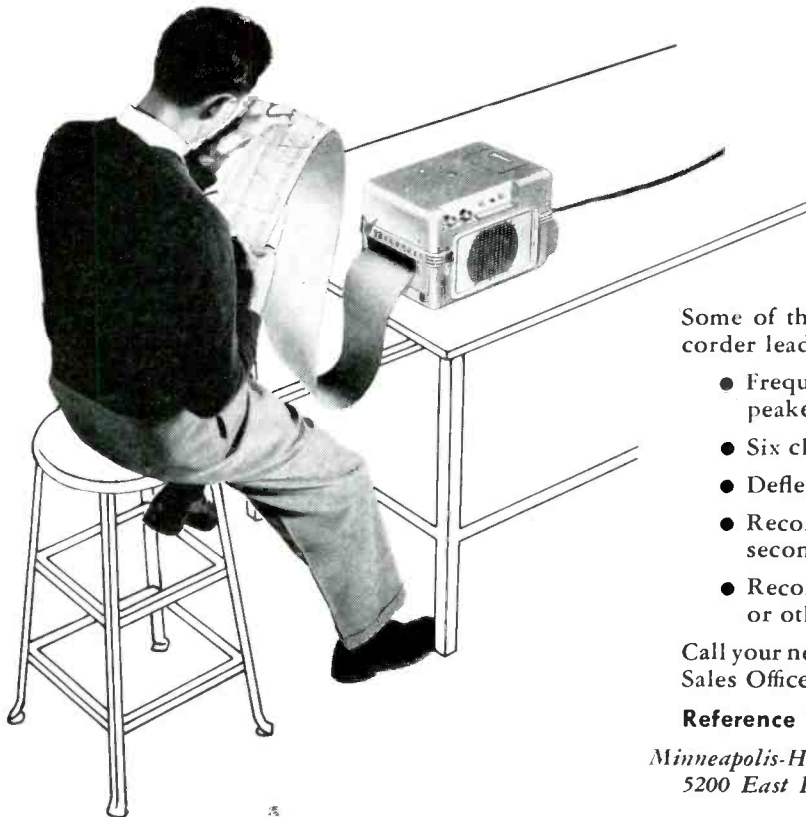

Some of the general features which give the Visicorder leadership in the direct-recording field are:

- Frequencies from DC to 2000 cps without peaked amplifiers or other compensation
- Six channels plus 2 timing traces on 6" paper
- Deflection 6" peak to peak; traces may overlap
- Record speeds 0.2, 1, 5, and 25 inches per second, minute, or hour
- Records require no liquids, powders, vapors, or other processing

Call your nearest Minneapolis-Honeywell Industrial Sales Office for a demonstration.

Reference Data: Write for Visicorder Bulletin

*Minneapolis-Honeywell Regulator Co., Heiland Division,
5200 East Evans Avenue, Denver 22, Colorado.*

MINNEAPOLIS
Honeywell



Heiland Division

NEW

oblique plier

with the exclusive

Klein Shear Cutter



Patent applied for

207-5C shear cutting oblique plier 5½ inches long. Will cut dead soft or extremely hard wire. Blade replaceable. Plier never needs sharpening. Regular cutting knives at the nose. Coil spring keeps jaws apart ready for use.

Here is the greatest advance in oblique cutters. This new Klein tool with shear blades is ideal for cutting hard wire such as tungsten filament or dead soft wire. Also recommended for cutting small bundles of wire. The shearing action assures easy, positive cutting at all times.

Regular cutters at the nose give added usefulness and convenience. Shear blade is replaceable. Plier never needs sharpening.

This plier is supplied with a coil spring to keep the handles in open position. Can also be had with Plastisol dipped handles if desired.

Write for full information

ASK YOUR SUPPLIER

Foreign Distributor:
International Standard Electric Corp.
New York



KLEIN LONG NOSE SHEAR CUTTING PLIERS



Patent applied for

208-6C long nose shear cutting plier. A 6½-inch long nose plier with shear blades. Will cut dead soft or extremely hard wire. Blade replaceable. Plier never needs sharpening. Point of nose 1/16-inch diameter. Coil spring keeps jaws open ready for use.



Patent applied for

208-6NC. Similar in design to 208-6C but reverse side designed to put a positive 3/16-inch hook on the end of a resistor wire. Smooth one-motion operation saves production time on every television or radio set.

Mathias KLEIN & Sons
Established 1857 Chicago, Ill., U.S.A.
7200 McCORMICK ROAD • CHICAGO 45, ILLINOIS



Better Things for Better Living
through Chemistry

ELECTRONIC DESIGN

LATEST PROPERTY AND APPLICATION DATA ON

TEFLON

tetrafluoroethylene
resins

NEWS

Impedance-matching weather protection of Du Pont **TEFLON**[®] tetrafluoroethylene resins featured in new variable-polarization K-band antenna

Du Pont **TEFLON** tetrafluoroethylene resins are uniquely qualified as materials for making the matching devices and radome used in the feed system of the new Diamond K-brand antenna. The 16,000 mc radar signal passes through an impedance-matching and weatherizing system based on components of a **TEFLON** resin, and is reflected from the accurate parabolic dish. The .027" wall of the radome matches the horn to space.

No other material could compare with **TEFLON** resins for this highly critical electronic application. They are unaffected by outdoor weathering and have so little moisture absorption that their dielectric constant remains unchanged under all humidity conditions. The very low dielectric constant of **TEFLON** resins gives the material its excellent matching characteristics. They are rated at 2.1 from 60 cycles through the super-high frequency range and have a power factor of under 0.0003 from 60 cycles to over 10,000 mc, so that the loss figure in transmission is very low. Dirt has no tendency to stick to the naturally "slick" surface. **TEFLON** is unaffected by heating to 260° C.

With this system, the plane of polarization can be varied a full 90° by Faraday rotation. Use of a **TEFLON** resin overcomes the impedance-matching problem. Moreover, no orienting effects are produced by radomes of this resin. VSWR of the antenna is less than 1.2: 1 over the required ±1% frequency band.

For your own designs, you are invited to take a closer look at the many outstanding advantages of Du Pont **TEFLON** tetrafluoroethylene resins in electronic applications. The coupon will bring you details.

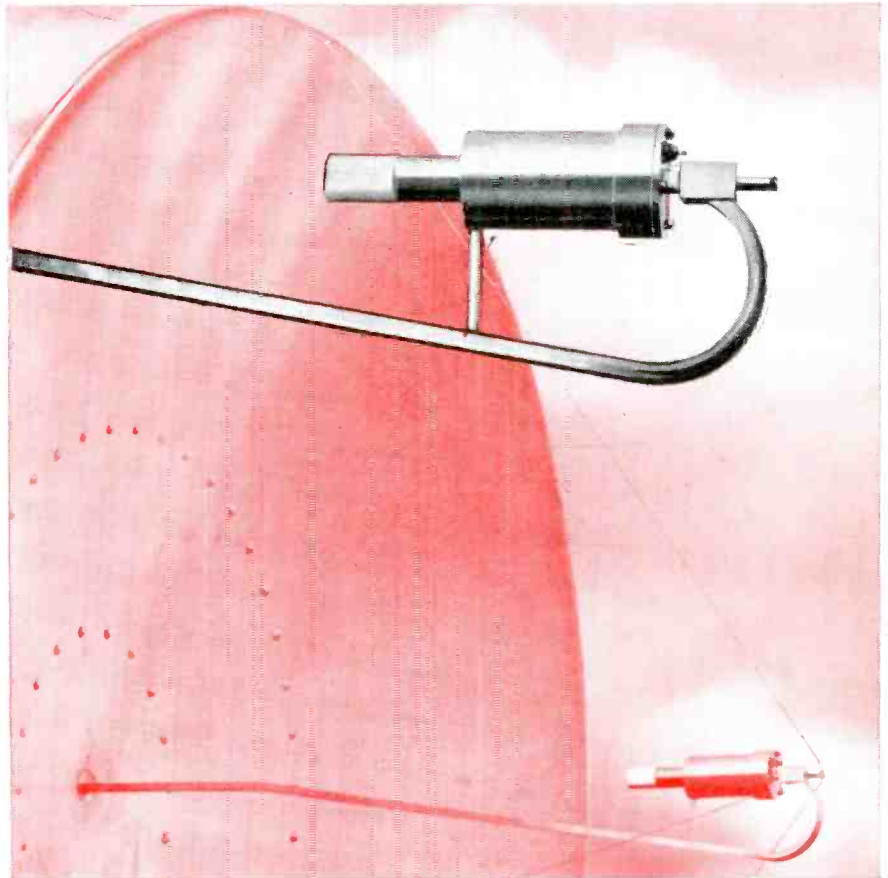

RADOME of a **TEFLON** resin matches impedance of feed horn to space and provides protection against weather. Wave-guide impedances at input and output of ferromagnetic

rotator in the feed are matched with minimum insertion loss by internal cones of a **TEFLON** resin. (Made by Diamond Antenna and Microwave Corp., Wakefield, Mass.)

Tapes made of **TEFLON**[®] tetrafluoroethylene resins provide high dielectric strength

Tapes made of **TEFLON** resins are strong, smooth and easy to handle. They have a dielectric strength of 500 to 4,000 volts, depending on thickness. Arc resistance is high, too; no carbonized path is formed by a surface arc. Tapes of

TEFLON resins make high-grade electrical insulation which "snugs down" easily, conforms to sharp corners and odd shapes, and becomes tighter as temperature rises.

TEFLON[®]

is a registered trademark . . .

TEFLON is Du Pont's registered trademark for its fluorocarbon resins, including the tetrafluoroethylene resins discussed herein. This registered trademark should not be used as an adjective to describe any product, nor should it be used in whole, or in part, as a trademark for a product of another concern.

SEND FOR INFORMATION

For additional property and application data on Du Pont **TEFLON** tetrafluoroethylene resins, mail this coupon.

E. I. du Pont de Nemours & Co. (Inc.), Polychemicals Dept.
Room 17-11-1, Du Pont Building, Wilmington 98, Delaware

Please send me more information on Du Pont **TEFLON** tetrafluoroethylene resins. I am interested in evaluating these materials for _____

Name _____

Company _____ Position _____

Street _____

City _____ State _____

Type of Business _____

In Canada: Du Pont Company of Canada (1956) Limited, P.O. Box 660, Montreal, Quebec

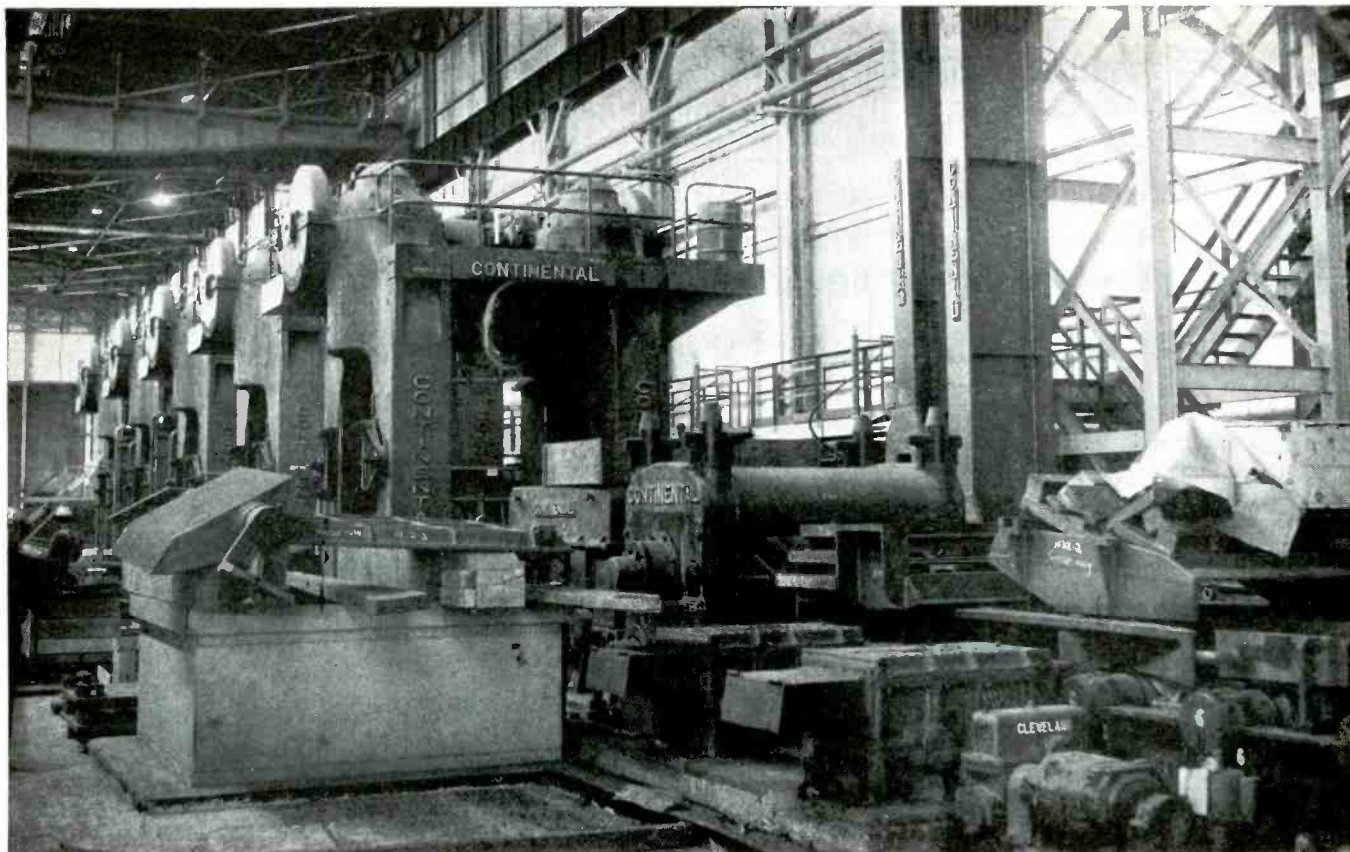

Now Under Construction...

New Production Capacity for Armco Oriented Electrical Steels

To help meet the growing demand for performance-improving oriented steels, Armco Steel Corporation is expanding production facilities for these grades. Completion of the expansion program is scheduled for 1958.

Armco pioneered development of the oriented electrical steels that have created new standards of efficiency for transformer design and operation. The new production capacity is a continuation of Armco's cooperation with the electrical industry to produce more and better steels for improved electrical and electronic equipment.

DESIGN DATA ON ORIENTED GRADES

The fourth edition of the catalog, "Armco Oriented Electrical Steels," contains extensive, up-to-date design information. More than 40 pages of graphical data on magnetic properties enable designers to make the most effective and economical use of these special Armco Steels.

This useful manual shows how stacked or wound cores made of Armco Oriented Electrical Steel can improve the

performance and cut the cost of your products. Write us today for a free copy. Just ask for the manual, "Armco Oriented Electrical Steels—Fourth Edition, 1957."

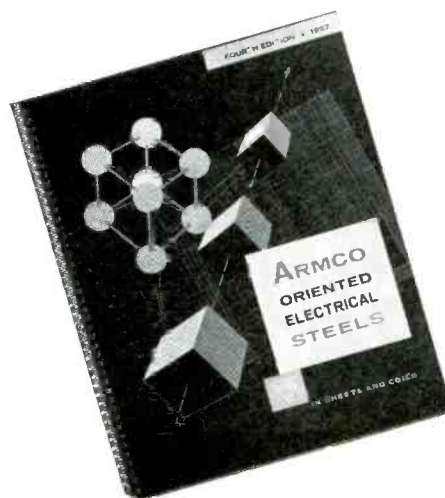

ARMCO STEEL CORPORATION

2277 CURTIS STREET, MIDDLETOWN, OHIO

SHEFFIELD DIVISION • ARMCO DRAINAGE & METAL PRODUCTS, INC. • THE ARMCO INTERNATIONAL CORPORATION



SHORT FORM CATALOG

Plastics for Electronics

Emerson & Cuming, Inc.

869 Washington Street, Canton, Mass.

Stycast Casting Resins

Epoxy! Polyesters! Polystyrenes! Foams!

Stycast 2850GT is an epoxy casting resin which has excellent high temperature properties, good adhesion to a wide range of materials, an extremely low thermal expansion coefficient and low shrinkage during cure.

Stycast 2741 is an epoxy system of controlled flexibility. Resultant compositions can be made semi-rigid or rubbery. Cure may be at room temperature. Exceptional adhesion to metals, plastics, glass, etc.

Stycast 1090 is a low weight (Specific Gravity 0.6) epoxide casting resin for electronic embedments. It has an extremely wide temperature range of usefulness. Low shrinkage during cure and low thermal expansion coefficient are other important properties. It cures at room or elevated temperature to a black, rigid, opaque solid. It is particularly useful in airborne embedment applications. Stycast 1090 has a low dielectric constant and, therefore, has minimum effect on circuit operation. When cured the material is completely unicellular; moisture absorption is negligible. The weight of Stycast 1090 is much less than half of that of other commonly used casting resins.

Stycast TPM-2 and Stycast TPM-3 are low loss, low dielectric constant thermosetting casting resins. They are useable over an extremely wide temperature range. When fully cured, they are resilient, white, opaque solids.

Stycast 1095 is a low weight epoxy casting resin which flows easily and cures readily with Catalyst 17 to a 500° F. continuous use material. Its specific gravity is 0.61.

Stycast 2651 is an easy to use, low cost, epoxy type casting resin with excellent adhesion to metals, plastics and ceramics. It is a general purpose material and is useful in almost all applications. It has a low thermal coefficient of expansion and is stable over a temperature range of -100 to +400° F.

Stycast 2662 is an epoxide casting resin which exhibits outstanding physical and electrical properties at elevated temperature. Heat distortion temperature is in excess of 500° F. It can be used for short periods of time at 600° F. Continuously at 500° F. At 500° F. volume resistivity is 10¹¹ ohm-cm. Stycast 2662 is used for electronic embedments, a high temperature sealer/adhesive and as a surface coating.

SALES REPRESENTATIVES

NEW ENGLAND

Smith & Purdy Associates
944 Main Street
Walpole, Mass.
Montrose 8-2460

NEW YORK

Stanley Fishner
P. O. Box 1012
Rome, N. Y.
Rome 6302

DAYTON

Robert G. Siff & Associates
341 No. Robert Blvd.
Dayton 2, Ohio
Hemlock 1254

WICHITA

Engineering Services Company
618 George Washington Blvd.
Wichita, Kans.
Amherst 2-6516

LOS ANGELES

McCarthy Associates
1055 East Walnut Street
Pasadena, California
Ryan 1-8810

NEW YORK

P. G. MacNeill
100 Wellwood Drive
Fayetteville, N. Y.
Neptune 7-9205

PHILADELPHIA

Andco Sales-Engineering
5823 Greene Street
Philadelphia 44, Pa.
Victor 4-9100

CHICAGO

Warren B. Cozzens Company
845 Chicago Ave.
Evanston, Illinois
Davis 8-4800

DENVER

Hytroic Measurement, Inc.
1295 South Bannock Street
Denver 23, Colorado
Sherman 4-2241

SAN FRANCISCO

McCarthy Associates
441 West California Avenue
Palo Alto, California
Davenport 5-6136

NEW YORK

L. E. Markle, Jr.
115 Mill Street
Williamsville 21, N. Y.
Plaza 4592

WASHINGTON, D. C.

Ted Britt, Rm. 14
1500 Massachusetts Avenue, N.W.
Washington 5, D. C.
Columbia 5-2694

ST. LOUIS

Engineering Services Company
6635 Delmar Blvd.
St. Louis 5, Mo.
Volunteer 3-3661

DALLAS

Lawrence Sales Company
P. O. Box 13026
Dallas 20, Texas
Fleetwood 2-7484

SEATTLE

Ray Johnston Company
11009 Evanston Avenue
Seattle 33, Washington
Emerson 0956

NEW YORK

The Creek Corporation
Lumber Road, Post Office Box 104
Roslyn, L. I., N. Y.
Roslyn 3-0827

CLEVELAND

Midwest Sales Company
3219 West 117th Street
Cleveland 11, Ohio
Winton 1-2700

KANSAS CITY

Engineering Services Company
4550 Main Street
Kansas City 11, Mo.
Jefferson 1, 7765

SAN DIEGO

McCarthy Associates
934 West Laurel Street
San Diego 1, California
Belmont 9-4015

FLORIDA & SOUTHEAST

Dbm. Research Corporation
Stoddard Building
Cocoa Beach, Florida
Cocoa Beach 2438

QUEBEC-ONTARIO

M. J. Howard & Company
132 Crocus Avenue
Ottawa, Canada
Central 5-9931

on Any of these Materials

Eccofoam Plastic Foams

Foam in Place! Pack in Place!
Liquids Powders Sheet Stock

Eccofoam PS is a series of low weight, extremely low loss polystyrene plastic foams of adjusted dielectric constant. It finds use in microwave lens, waveguide and antenna applications.

Eccofoam Hi K 1000F is a one-part pack-in-place adjusted dielectric constant ultra high temperature foam of a ceramic base. It is available in dielectric constants 2.0 through 6.0 and is capable of continuous operation at 1000° F. Being a one-part system it is very simple to use. It is silver in color. This material is also supplied in sheet form.

Eccofoam Hi K 625D is a one-part epoxide "pack-in-place" artificial dielectric foam. It is available in a range of dielectric constants from 2.0 to 7.0. It is useable at 500° F. continuously. Higher temperature usage is also possible. Samples have been subjected to 1000° F. Supplied in a form resembling damp sand. A one-part system, no mixing of components is required. Sheets of this material are also available.

Eccofoam DPT is a one-part "pack-in-place" epoxide foam useable to 500° F. when fully cured. No mixing is required. It is used as received, packed or tamped into cavity to be filled and cured at moderately elevated temperature. The finished foam is extremely fine and uniform.

Write for Technical Bulletins on Any of these Materials

Eccoseal Impregnating Resins

EPOXIDES — POLYESTERS

LOW LOSS HIGH TEMPERATURE NON-FLAMMABLE

Eccoseal W28G, a one-part epoxide, intended primarily as an impregnant for transformers and coils. Also used as a casting resin. Has excellent high temperature properties. Impregnated units have operated continuously at 200° C. (392° F.) and for short periods as high as 250° C. (482° F.) It is solvent-free and requires no catalyst addition. Cures to a thermosetting plastic; vacuum treatment assures complete filling of windings. Adhesion to a variety of materials is outstanding. Shrinkage is very low.

Eccoseal W19 is a low viscosity epoxide impregnant and casting resin. It can be cured at room or elevated temperature. It is used to embed small items or impregnate large windings.

Eccoseal W44HT polymerizes 100% by weight into an excellent high temperature, completely non-flammable solid. Manufactured as a light brown, low viscosity liquid, with good wetting characteristics. Long pot life when properly catalyzed. Stable as an impregnant over the temperature range -90° F. to +400° F. A high dielectric strength material with relatively low dissipation factor.

Eccoseal High Q is a low loss impregnant and coating used for a wide variety of R.F. and Microwave applications. It is a resin in solvent solution. Thinner supplied for dilution. Based on polystyrene, its coatings have excellent moisture resistance, low dielectric constant, low loss, and high insulation resistance. Used as a lacquer for RF coils, as a reinforcing medium to up-grade paper, fabric and wood. It is a general purpose coil dope.

Eccoseal W66 is an epoxide impregnating resin which is stable at 600° F. Supplied as a relatively low viscosity liquid and is used with Catalyst #17.

Eccofoam PT is one of a series of pack-in-place epoxy foams. It can be cured completely at room temperature and then is capable of use at 300° F. continuously, or 350° F. for short periods. The bulk density of Eccofoam PT is about 20 lbs./cu. ft. It is extremely fine and uniform in structure. It is supplied in two components resembling damp sand. Used as a potting compound, for sandwich structures, a light-weight adhesive or caulking compound, for thermal insulation and light weight structures.

Eccofoam FP is rigid polyurethane foam-in-place liquid resin. Upon addition of a catalyst, it expands and finally cures to a rigid thermosetting unicellular foam of specified density. It can be processed completely at room temperature. Volumes of several cubic feet of excellent structure can be made in one pouring due to the very low exotherm developed.

Eccofoam S and Eccofoam FS respectively, are rigid and flexible polyurethane foam sheets. Eccofoam S is available in a wide range of densities. Both will withstand a wide temperature range.

Eccofoam LM is a one-part pack-in-place type ceramic foam which when cured will produce a very fine grained, rigid foam structure of 18-20#/cu. ft. Thermally stable at 1200° F. It exhibits very low dielectric loss over the entire temperature range of use.

Eccocoat Plastic Surface Coatings

Liquids and Powders — for Brushing,
Dipping, Spraying, or Dusting!

Eccocoat EC 200 is a general purpose spray, brush, or dip epoxide surface coating. It can be cured at room temperature or rapidly at elevated temperature. Surface coatings of Eccocoat EC 200 are of a quality heretofore obtainable only in baked finishes. It is clear; its films are transparent.

Eccocoat Powder HP is a one part epoxy system composed of a finely divided powder. The method of use is to suspend the powder in a flowing gas stream such as air and to dip therein preheated components or circuits. The powder melts in place and coalesces to a smooth thin film. Multiple films can be applied by reheating and redipping. Final cure is accomplished after applying the proper coating thickness. Excellent adhesion and moisture resistance are outstanding characteristics. Temperature capability is 450° F.

Eccocoat PCA is used as a spray coat and cement for printed circuit boards. It is an effective cement for bonding components to the boards. This is usually combined with the coating procedure. Excellent bond strength is achieved even against glass components. Field tests indicate that Eccocoat PCA cemented boards are capable of withstanding accelerations in excess of 100 G's without failure.

Eccocoat C26 is a clear epoxide surface coating which has exceptional high temperature properties. It can be used continuously at 500° F. and for short periods up to 600° F. Surface resistivity is above 10¹⁵ ohms at room temperature and remains above 10¹⁴ even at 500° F. Moisture and chemical resistance is outstanding. For example, prolonged exposure to Skydrol at high temperature is not harmful. Eccocoat C 26 is applied by dip, brush, or spray.

Write for Technical Bulletins

Eccobond Adhesives, Cements and Sealants

Liquid, paste or
powder

Highly Resistive or Conductive!

Eccobond 55 is a low viscosity epoxide adhesive for joining metal, glass, ceramics and plastics and for crack filling. It can be cured at room temperature or for rapid cures at elevated temperature. The adhesive is white in color (other colors available) and is rigid when cured.

Eccobond 45 is a controlled flexibility epoxide adhesive. It is designed for use where shock and peel resistance are desired. Cures at room temperature or more rapidly at higher temperature. Adhesion to metals, glass, ceramic and plastic: excellent.

Eccobond 76 is an epoxide adhesive and sealant capable of continuous use at 500° F. and for short periods at 600° F. It is used to bond metal, glass, ceramic and high temperature plastic compositions. The aircraft industry uses Eccobond 76 as a metal to metal structural sealant. The material has excellent resistance to chlorinated hydraulic fluids, e. g., Skydrol 500. Eccobond 76 is supplied as a highly viscous liquid. When mixed with Catalyst #14, a powder, it is a non-flowing paste. Final color is black.

Eccobond Solder 56C is a plastic cement which when cured has extremely low electrical resistance. It can be cured at temperatures as low as 120° F. in 2 hrs. or in a matter of a few minutes at elevated temperature. Supplied in paste form, the cement will not flow when applied. It adheres tenaciously to metal, glass, ceramic and plastics. It is used for making electrical connections where hot soldering is impractical, for example, to nichrome wire, or conductive plastics and at locations which cannot be subjected to high temperature.

Eccobond Paste 88 and Eccobond Powder 98 are one-part adhesives which are applied and then merely heated to effect cure. Simplicity of use is the big advantage. Both are outstanding at high temperatures. Eccobond Paste 88 has replaced riveting and soldering in many applications.

Eccomold Laminating Resins

Low-loss! Non-flammable! Ultra high temperature!

Eccomold L65 is a laminating resin of low loss and low dielectric constant used in applications where outstanding electrical characteristics are required—radomes, dielectric support pieces, printed circuit boards, etc. It is a thermosetting material. Parts made from it withstand 300° F. continuously.

Eccomold L44 is a resin for use with glass reinforcement to produce laminates of outstanding electrical qualities. Laminates of over 50% by weight glass loading are structurally and electrically sound at temperatures in excess of 200° C. Readily pigmented to a variety of colors with excellent surface finish. It will not support combustion.

Eccomold L28 is a general purpose epoxide laminating resin. Cures at room temperature (Catalyst #9) or higher heats (Catalyst #11) to produce high strength laminates. Used in conjunction with fiberglass cloth or mat. Matched metal, vacuum bag or wet layup can be used. Catalyst #11 is recommended for long pot life in production applications and/or where high temperature properties are needed in the finished laminate.

Eccomold L266 an epoxide laminating resin with outstanding high temperature properties. Fiberglass laminates made with it will withstand 500° F. continuously, or 600° F. for short periods.

Eccostock Plastic Rods and Sheets

High Temperature — Light weight
Low Loss
Adjusted Dielectric Constant

Stycast 0005 — Plastic rod and sheet for RF and Microwave insulation. This is a specially developed clear plastic material featured by low dissipation factor, excellent high and low temperature stability and machining ease. It is available in rods and sheets.

Stycast Hi K is a series of plastic rod and sheet stock of adjusted dielectric constant. Dissipation factor is low. It is intended for RF and Microwave applications. The material is white and opaque. It is available as standard material in the following dielectric constants: 3, 4, 5, 6, 7, 8, 9, 10, 11, 12, 13, 14 and 15. Standard rod sizes are 1, 2 and 3 inch diameters. Standard sheet thicknesses are ½ and 1 inch. Other dielectric constants and sizes are available on special order. From 10⁶ to 10¹⁰ cycles the variation in dielectric constant is ±0.15 maximum; dissipation factor is below 0.001. Volume Resistivity — greater than 10¹⁴ ohm-cm³. Dielectric Strength — greater than 500 volts/mil.

Stycast Lo K is low dielectric constant, low loss and low weight thermosetting plastic rod and sheet for RF and Microwave insulation. It is specifically designed for use in coaxial, waveguide and antenna support problems. Due to low dielectric constant, reflections in transmission lines are minimized.

Eccostock R25 is epoxide rod and sheet stock capable of operating at 500° F. Readily machinable, it has a variety of uses, including bobbins for coils and resistors, terminal boards and insulators. It can be cemented easily.

Eccostock R19 is epoxide rod and sheet which is featured by machining ease and moderately high temperature properties. The material is useable continuously from -100° F. to +350° F. Physical and electrical properties are outstanding.

Eccostock R20 combines light weight, machining ease, good dimensional stability and good high temperature properties. The material is completely unicellular; moisture absorption is negligible. Operating temperature range is from -100° F. to +350° F. Its specific gravity is 0.61.

Ecco Reflector and Ecco Luneberg Lens

3" 7" 12" 18" 36" Diameters Target cross sections to 56,000 sq. ft.

The Ecco Luneberg Lens is a variable dielectric constant device of spherical contour which focuses an incident plane electromagnetic energy wave to a point on its surface, or conversely produces a plane wave from a point source. There are many unique applications for the Ecco Luneberg Lens; one important application is rapid wide angle scanning of a radiation beam by moving a small feed over the surface of the stationary lens; another is an efficient electromagnetic energy reflector.

The Ecco Reflector is effective as a passive target for radar energy. It has a large radar cross section which is essentially constant over a wide conical viewing angle. The Ecco Reflector is compact, rugged, light in weight and easily installed. It is broadbanded throughout the microwave frequency range. The reflector is based on the Ecco Luneberg Lens. Energy incident upon the lens is focused and reradiated in the direction from which it originated. In this respect, it is similar to a corner reflector. The Ecco Reflector is far superior to the corner reflector for wide angle coverage; it has a radar cross section approximately eight times that of a circular corner reflector of the same radius.

Emerson & Cuming, Inc.
869 Washington Street, Canton, Mass.

Plastics for Electronics

Emerson & Cuming, Inc.

Plastics for Electronics

SHORT FORM CATALOG

This, our general, short-form catalog, contains a brief listing and description of some of the materials we have available. More detailed information on those listed below as well as our other products is available in individual brochures on each of the various lines mentioned, and we will be very pleased to supply you with any of these or any other information you may desire upon request.

Eccosorb Microwave Absorbers

For Free Space Rooms — 50 Mc thru Microwaves!
Flexible or Rigid — Waveguide Absorbers!

Eccosorb FR is a series of broadband rigid foam microwave absorbers for use in "free space" rooms. Antenna measurements made in a room lined with this absorber are comparable to those made at an outdoor test range. It reflects less than 2% of normal incident energy over the design frequency range, i.e., reflectivity is down greater than 18 db. Selected pieces can be supplied at less than 1% reflectivity. It is effective against parallel, perpendicular and circular polarizations. The absorber is white surfaced for good lighting conditions and is extremely light in weight. Outdoor exposure has no harmful effect on absorber performance. Eccosorb FR is supplied in blocks 1' x 3'. Thickness is dependent upon the longest wavelength at which it is to be effective. Power dissipation exceeds 2 watts/sq. in. Self-extinguishing after exposure to flame.

Eccosorb AN is a light weight flexible foam sheet broadband microwave absorber. Used mainly for lining antenna nacelles and enclosures, it can readily be cemented to or draped over items which produce undesired reflections. It reflects less than 2% of normal incident energy over the design frequency range. Eccosorb AN is equally effective against parallel, perpendicular and circular polarizations and is relatively insensitive with respect to incident angle.

Eccosorb CHW is a series of broadband anechoic chamber absorbers for use in the v.h.f. u.h.f. and microwave regions, offered in three standard types. It is composed of light weight pyramids, mounted on a rigid foam base and is broadbanded. For example, Eccosorb CHW 560 is effective at 50 mc. and at all higher frequencies, extending even into the microwave region. Thus, an anechoic chamber which uses Eccosorb CHW 560 can be used to make v.h.f., u.h.f. and microwave measurements, simultaneously if desired. This opens the possibility of simultaneous checking of several complete systems installed in an aircraft or missile.

Eccosorb CH is a series of broadband absorbers for use in microwave darkrooms. Reflecting less than 2% of the energy incident upon its surface, this

absorber permits antenna measurements to be made indoors with the same reliability and none of the weather uncertainty of outdoor measurements. It is light weight and flexible — composed of enmeshed, rubberized fibers and supplied in sheets, 2 feet by 2 feet. Thickness is dependent upon the longest wavelength at which the absorber is effective. The surface is white in color for good light reflection.

Eccosorb MF is a series of plastic rod and sheet which is used in waveguide as absorbers, attenuators, terminations and loads. Over the entire microwave frequency range these materials have a high total dissipation factor. Attenuation per unit length is, therefore, high.

Eccosorb Panelling offers a prefabricated large size portable absorber panel which because of its light weight can readily be moved from place to place and erected within minutes. The panels are offered in convenient sizes and individual panels can be readily locked to adjoining ones to present a continuous absorber wall and electrical screen.

Eccosorb RM is a flexible sheet absorber which is broadbanded throughout X band and can be used at 600° F. It can be contoured to compound curves and can be cut into smaller pieces. When properly installed Eccosorb RM is completely moisture tight.

Eccosorb Caps are metallic housings lined on the inside with an appropriate Eccosorb product. They are used to cap or cover a radiating antenna 1.) to confine the radiated energy within the cap and 2.) to terminate the antenna in essentially free space conditions. Eccosorb Caps are provided with a Type N bulkhead connector so that a probe can be attached internally to monitor antenna output. They can be supplied to cover the frequency range from 200 MC to 30,000 MC.

Eccosorb HT is a broadband microwave absorber useable to 1200° F. It is supplied as light weight ceramic blocks. Because of its high temperature capability, Eccosorb HT can be used where high power levels must be absorbed.

Write for Technical Bulletins

Plastics for Electronics

Emerson & Cuming, Inc.
869 Washington Street, Canton, Mass.



Ratiometer

...accurate to five parts per million!

REFERENCED TO UNITY RATIO

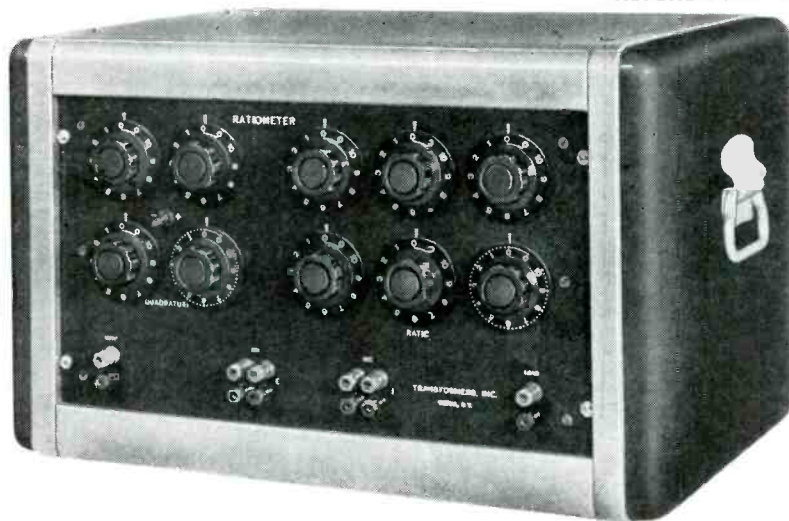

The Transformers, Inc. Ratiometer is a precision instrument to measure any voltage ratio from 0.000001 to 1.111111. Transformer ratios can be accurately measured at "no load" and under full load. Two models are available:

MODEL 204 is designed for use between 200 cps and 2,000 cps. It is supplied with plug-in units for 400 cps operation.

MODEL 206 is designed for use between 40 cps and 1,000 cps. It is supplied with plug-in units for 60 cps operation.

Plug-in units for any other frequency are supplied to order.

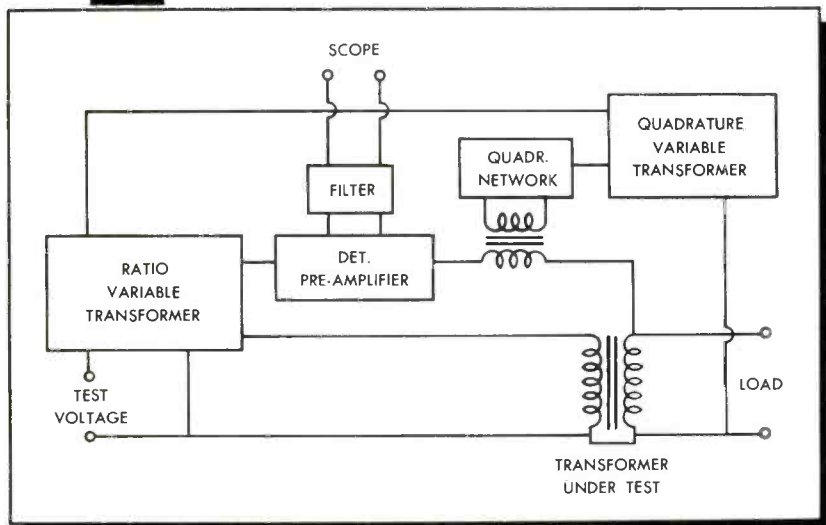

The Ratiometer consists of two precision variable transformers, a calibrated quadrature injector, a filter, and a pre-amplifier. Block diagram indicates connections of the various components within the instrument.

ACCURACY

Five parts per million referenced to unity ratio.

MAXIMUM VOLTAGE

Model 204	120 V	200 cps
	180 V	300 cps
	240 V	400 cps and over
Model 206	80 V	40 cps
	120 V	60 cps
	240 V	120 cps and over

PRICE

Model 204 Ratiometer, complete with 400 cps plug-in filter and quadrature units **\$865**

Model 206 Ratiometer, complete with 60 cps plug-in filter and quadrature units **\$1235**

For additional information, ask for Bulletin #204

TRANSFORMERS, INCORPORATED

200 Stage Road, Vestal, N.Y.

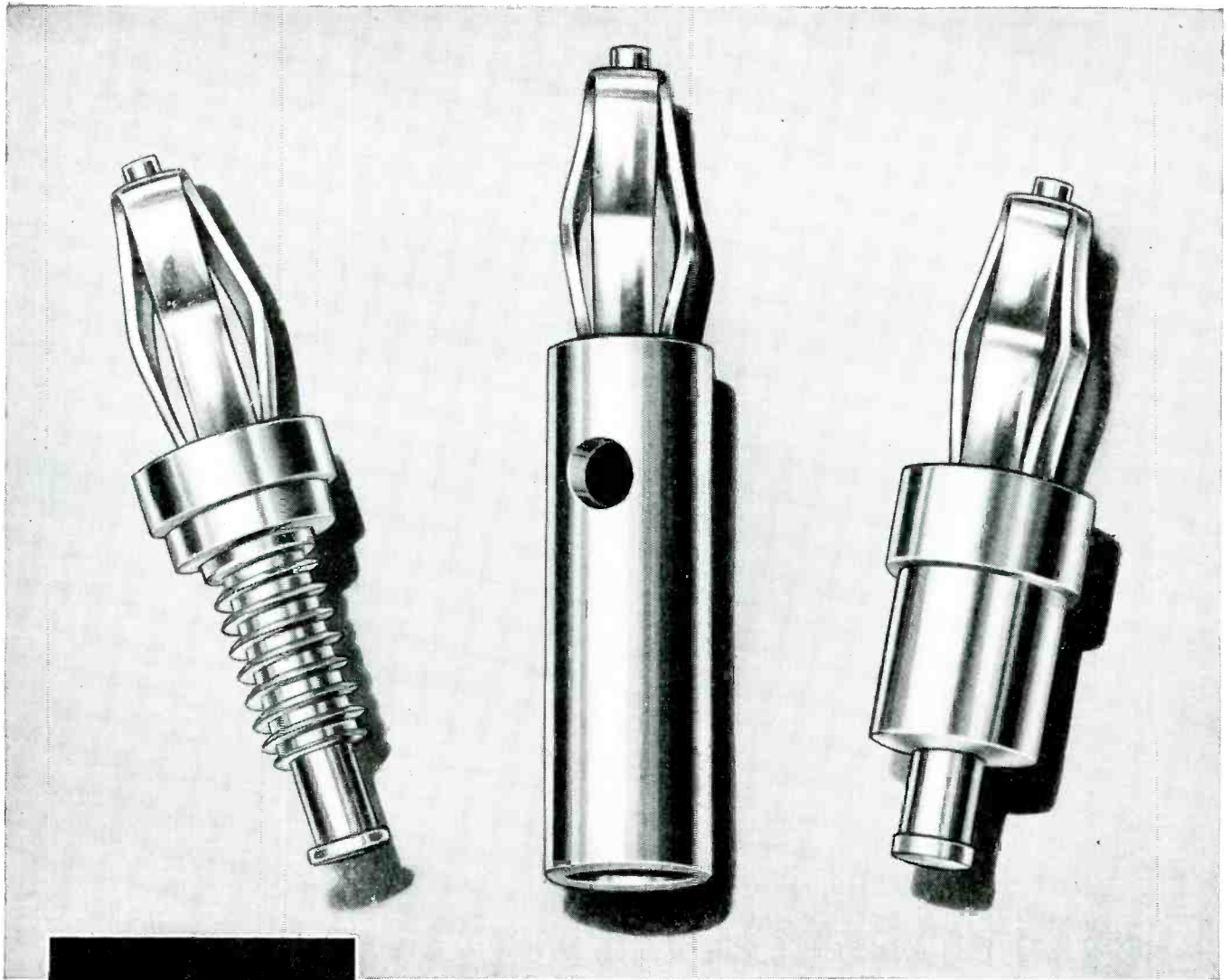

6 times enlargement

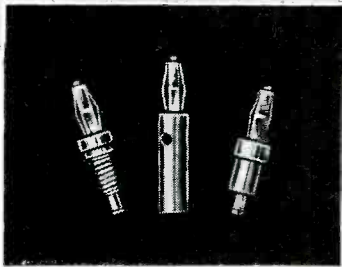

Actual size

Ucinite Miniature Banana Pins

Heavy resistance to torque is a big feature of Ucinite miniature banana pins. The springs are mechanically riveted over and the large area around the tip of the pin is bonded by solder.

Pins are available in a variety of types, for assembly by staking . . . with nuts and washers . . . with soldered tails . . . with multiple plug-in features. Springs are designed to fit .093 sockets.

Built to withstand rough usage, Ucinite miniature banana pins are available in cadmium, silver or gold plate.

For further information, call your nearest United-Carr representative or write directly to us.

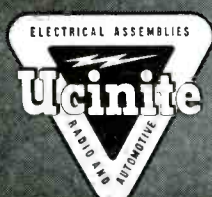

The
UCINITE CO.
Newtonville 60, Mass.
Division of United-Carr Fastener Corp.

Specialists in
ELECTRICAL ASSEMBLIES,
RADIO AND AUTOMOTIVE

KIN TEL

[KAY LAB]

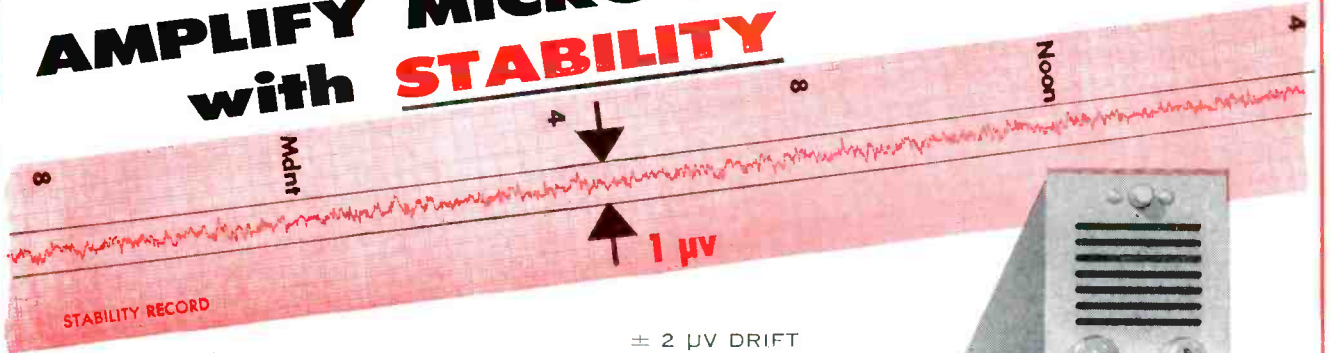
FOR DRIFT-FREE DC INSTRUMENTATION**AMPLIFY MICROVOLTS
with STABILITY**

± 2 μV DRIFT

INTEGRAL POWER SUPPLY

HIGH OUTPUT LEVEL

EXTREMELY LOW NOISE

BROAD BANDWIDTH

10 ACCURATE GAIN RANGES

HIGH INPUT IMPEDANCE

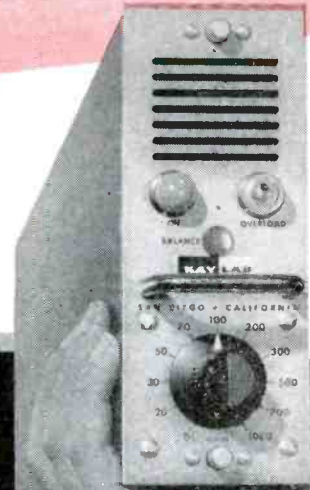
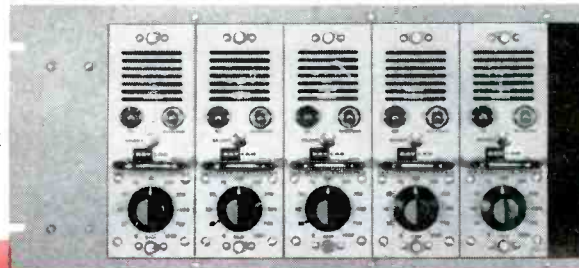

The KIN TEL Model 111 amplifier provides maximum stability and the lowest drift of any commercially available broadband d-c amplifier. It is the end result of years of research in the field of chopper stabilized broadband d-c amplifiers. Thousands of KIN TEL amplifiers are in daily use. The Model 111 incorporates KIN TEL's proven chopper amplifier circuitry and provides ten extremely precise, feedback controlled gain ranges. Several feedback loops assure high accuracy, stability and uniform frequency response. The completely new and unique circuit provides rapid recovery from severe overloading and unsurpassed dynamic performance—unaffected by load or gain changes.

The Model 111 is available in a single-unit cabinet or in a six-unit rack-mountable module. The amplifiers are extremely compact; the six-unit module occupies only a 19-inch rack width.

APPLICATIONS: The Model 111 is ideal for permanent low level d-c instrumentation, telemetering, or as a strain gage amplifier, transducer amplifier, scope preamplifier, recorder driver amplifier, or general purpose laboratory amplifier.

SPECIFICATIONS

Gain	0, 20, 30, 50, 70, 100, 200, 300, 500, 700, 1000
Gain Accuracy	± 1% DC to 2 KC
Input Impedance	100,000 Ω
Output Capability at DC	0 to ± 35 V where $R_L > 1000 \Omega$ 0 to ± 40 MA where R_L is 10 to 400 Ω
Output Impedance	Less than 1 Ω in series with 25 μh
Equivalent Input Drift	± 2 μv with regulated line
Equivalent Input Noise	0 to 3 cps, less than 5 μv peak to peak 0 to 750 cps, less than 5 μv RMS 0 to 50 kc, less than 12 μv RMS
Chopper Intermodulation	Less than 0.1%
Linearity	Better than 0.1% to 2 KC
Frequency Response	± 3% (0.3 db) DC to 10 KC, less than 3 db down at 40 KC

Power Requirements:	
Amplifier	117 V — 60 cycles — 70 VA
Cabinet	117 V — 60 cycles — 15 VA
6 Unit Rack Adaptor	117 V — 60 cycles — 45 VA
Dimensions: Amplifier Unit	2 3/4" wide, 7 1/2" high, 1 1/4" deep
Rack Adaptor for 6 Units	19" wide, 8 1/4" high, 1 1/4" deep
Net Weight — Amplifier	11 pounds
PRICE: Amplifier Unit	\$550.00
19-inch Rack Adaptor for 6 amplifier (with fans and connectors)	200.00
Cabinet for single amplifier (with fan and connector) is available.	

...the Standard in chopper-stabilized instruments

KIN TEL

[KAY LAB]

Representatives in all major cities.

5725 KEARNY VILLA ROAD, SAN DIEGO 11, CALIFORNIA BROWNING 7-6700.

STABILITY →  **Locked in!**
WITH CHOPPER AMPLIFIERS

PHELPS DODGE SODEREZE®

CUTS



FIRST FOR LASTING QUALITY—FROM MINE TO MARKET!

ENDS STRIPPING, CLEANING— SOLDERING COSTS !

Sodereze—Phelps Dodge's isocyanate-type* magnet wire—provides:

1. *Low temperature* soldering—no damage to copper conductor.
2. A balance of physical, chemical and electrical properties permitting replacement of existing film wires.
3. Resistance to heat and solvent shock for safer wax or varnish treatment.
4. Excellent resistance to alcohol and most solvents.

Phelps Dodge Sodereze was designed to keep pace with industry's growing need for magnet wires that handle easily, reduce over-all costs and fit a variety of exacting design requirements.

The versatility of Sodereze not only permits its use wherever solderable wires are required, but allows replacement of conventional film wires.

* Isocyanates, when combined with other resins, form Polyurethanes that can be balanced in properties to give the maximum in performance as a magnet wire insulation. Several years of research have been spent on Phelps Dodge Sodereze to accomplish this result. A patent application covering Phelps Dodge isocyanate-type magnet wire has been filed.

*Any time magnet wire is your problem,
consult Phelps Dodge for the quickest, easiest answer!*



PHELPS DODGE COPPER PRODUCTS
CORPORATION

INCA MANUFACTURING DIVISION
FORT WAYNE, INDIANA

AEROCOM'S 1046 H. F. TRANSMITTER

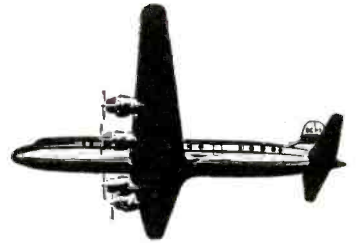

POWER + STABILITY

1000 WATTS

WITH

.003% STABILITY

Rugged, versatile general purpose H. F. transmitter—Aerocom's 1046 packs 1000 watts of power and high .003% stability under normal operating conditions (0° to +50°C.). Excellent for point-to-point or ground-to-air communications.

Multi-channel operation on telegraph A1, or telephone A3 with GM-8A modulator... new Aerocom 1046 can be *remotely controlled* with TMC-R at control position and uses only one pair of telephone lines. In A3 operation, the local dial control panel is located in modulator cabinet.

Transmitter cabinet has 8¾ inch panel space available for either local dial control panel or frequency shift keyer.

Model 1046 operates on 4 crystal-controlled frequencies (plus 2 closely spaced frequencies) in the band 2.0—24 Mcs. Operates on one frequency at a time; channeling time 2 seconds. Operates into either balanced or unbalanced loads. Operates in ambient -35° to +50° C. Power supply: nominal 220 volts, 50-60 cycles, single phase.

Complete technical data on request

Now! Complete-package, 192 channel, H. F., 75 pound airborne communications equipment by Aer-O-Com! Write us today for details!

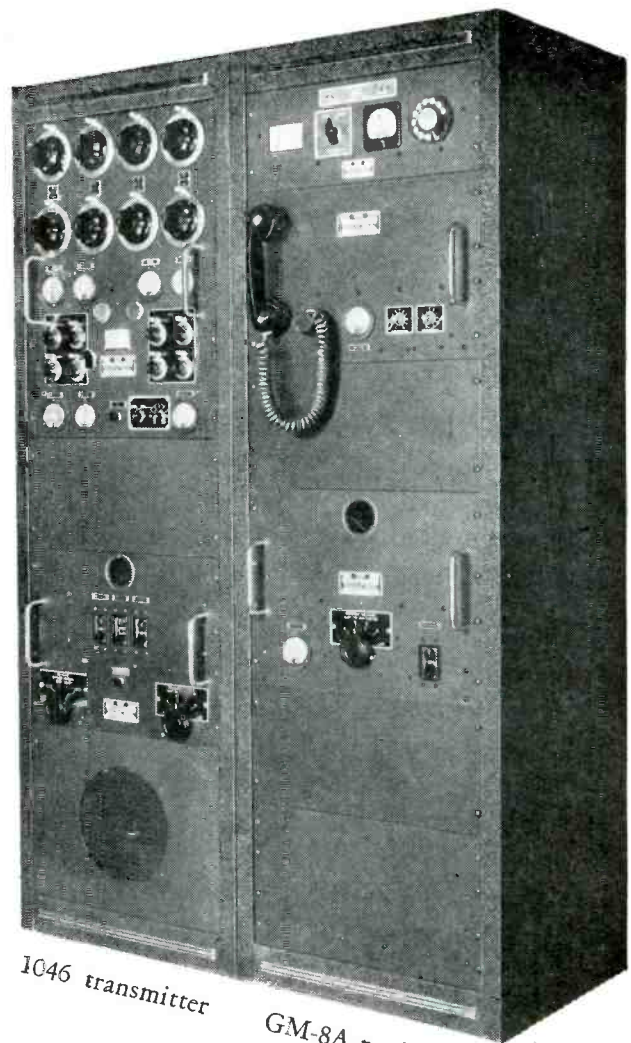

1046 transmitter

GM-8A modulator

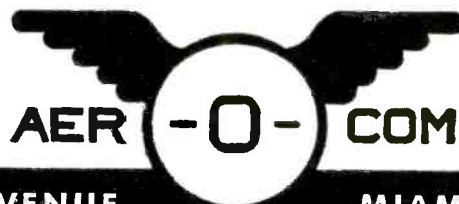

3090 S.W. 37th AVENUE

MIAMI 33, FLORIDA

**Relay
Sales**

Telephone
Relays

Midget
Relays

Keying
Relays

Rotary
Relays

Sealed
Relays

Sensitive
Relays

Latching
Relays

Stepping
Relays

Delay
Relays

Timers

Contactors

Motor Starting
Relays

Differential
Relays

Polarized
Relays

AN Approved
Relays

Write for Catalog
1957-C8

**Relay
Sales**

why wait for RELAYS

**LEADING MAKES—
LATEST TYPES
IN STOCK!**

C. P. CLARE
Mercury Wetted
Contact



**We maintain complete distributor
stocks of the following makes:**

**Advance Relays Phillips Controls
Automatic Electric Struthers-Dunn
Clare Leach Relays
Neomite-Elgin Terado and Others**

Potter & Brumfield

We Anticipate Your Relay Needs

Relay Sales cannot get better delivery from manufacturers than you. Relays now in stock were ordered as long as 10 months ago and selected by men who have specialized in supplying relays to the industry for many years. The items illustrated are typical of hundreds of thousands in stock. They are available in all popular coil ratings and contact arrangements. Why wait for relays? Call us today!

Write or Phone for Same Day Shipment

Phone: West Chicago 1100

RELAY SALES, INC.

P.O. BOX 186-A

West Chicago, Ill.

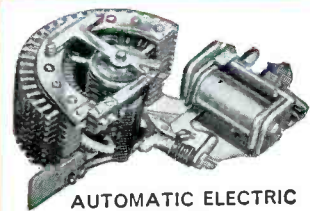

**AUTOMATIC ELECTRIC
Type 45 Stepper
Wide Selection**

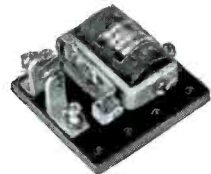

**STRUTHERS DUNN
Keying Relay
Many Types in Stock**

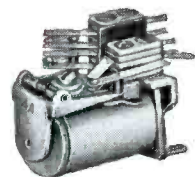

**PHILLIPS CONTROL
9QA Midget for Sub Chassis
Mounting. Many Others
in Stock**



(Actual Size)
**NEOMITE-ELGIN
Sub Miniature Hermetically Sealed
Relay. All Advance Types in Stock**

BRISTOL SYNCROVERTER* SWITCH

... the answer to your chopper and high-speed relay problems



100 billion operations and they're still going strong!

Syncroverter Choppers have run almost six years continuously at 400 and 600 cycles per second

That's the laboratory shelf-test record of a group of Bristol Syncroverter* Switches (above) that are being run at no load as a test for actual mechanical wear out. And they're still going strong!

These Syncroverter switches are predecessors of those being used in aircraft fire control systems, missiles, computers, electronic instruments, control systems, and many other electronic systems.

are dry circuits your problem?

If so, we believe we have the answer. Dry-circuit reliability and long life are outstanding features of the miniature Syncroverter chopper and high-speed polar relay. They are unaffected during severe shock and vibration and are available with the typical operating characteristics shown in the tables at right. They meet a wide variety of requirements. We'll be glad to discuss specific application problems with you.

NEW low-noise chopper available

The Bristol Syncroverter chopper is now offered in an exceptionally low-noise external coil model. Its external coil construction plus complete electrostatic shielding eliminates capacitive coupling between contact and coil leads. Peak-to-peak noise is less than 100 microvolts across 1 megohm impedance.

Write for complete data on the Bristol Syncroverter line.

TYPICAL CHARACTERISTICS:

Bristol's Syncroverter Switch
(covered by patents)

Driving frequency range:	0-2000 cps (400 cps used for these characteristics)
Coil voltage:	6.3V sine, square, pulse wave
Coil current:	55 milliamperes
Coil-resistance:	85 ohms
*Phase lag:	55° ± 10°
*Dissymmetry:	Less than 4%
Temperature:	-65°C to 125°C
*Switching time:	15° ± 5°
Operating Position:	Any
Mounting:	Flange or plug-in—fits 7-pin miniature socket

*These characteristics based on sine-wave excitation

Bristol's Syncroverter High-Speed Relay
SPDT or DPDT (covered by patents)

Temperature range:	-55°C to 100°C
Operating shock:	30G; 11 milliseconds duration
Vibration:	10-55 cps (see below, mounting): 10G
Contact ratings:	Up to 35V, 45 microamperes
Stray contact capacitance:	Less than 15 mmf.
Pull-in time (including bounce):	As low as 200 microseconds
Drop-out time:	300 microseconds
Life:	Over a billion operations under dry-circuit conditions

Mounting: Octal tube socket; others available, including types for vibration to 2000 cps



BRISTOL DYNAMASTER* ELECTRONIC RECORDERS...for research and testing

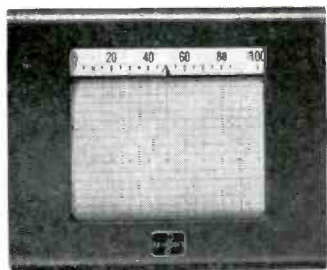

Bristol High-Speed Dynamaster Electronic Recorder

high-speed (0.4 sec.) recorder

... accurately follows the rapidly changing variables found in dynamic testing procedures such as those used in wind tunnel research, rocket and jet engine testing, and scientific laboratory work. Maintains same high accuracy, sensitivity, and precision as conventional speed recorders.

These other precision instruments by Bristol can also help you in aircraft and missile testing and development projects:

Dynamaster 2-pen Recorders Dynamaster Extended Range Recorders
Dynamaster Function Plotters Dynamaster Adjustable Span Recorders

Ask us for complete data on these instruments today.

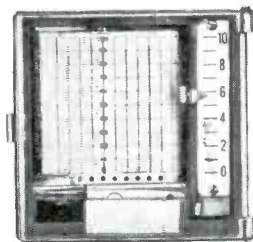

Bristol Series 663 Miniature Dynamaster Recorder

first true motor-driven self-balancing electronic potentiometer and bridge instruments in miniature size

Three-inch strip chart, full plug-in flexibility, 1/2 of 1% of scale accuracy, low dead band (0.15%), and high-torque motor-driven null-balancing are features of the Bristol Series 663 Dynamaster miniature instruments.

Plenty of motor torque for operating alarm contacts, retransmitting slide-wires, electric control contacts.

Bristol offers the widest selection of miniature plug-in instruments on the market — pneumatic, telemetering types; electronic self-balancing recorders, indicators. Find out about Bristol miniatures today!

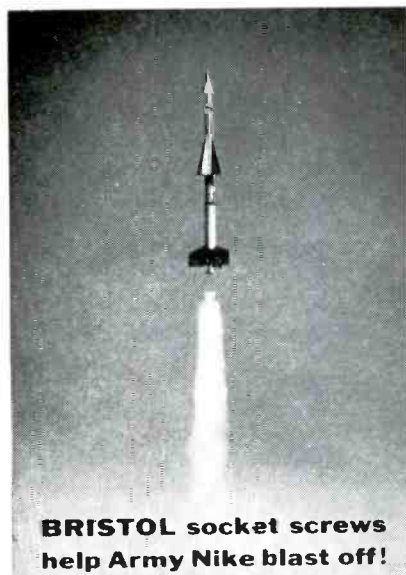

BRISTOL socket screws help Army Nike blast off!

*T. M. REG. U. S. PAT. OFF.

BRISTOL MULTIPLE-SPLINE SOCKET SCREWS prove reliability in missiles, aircraft, electronic equipment

They meet the most exacting requirements for holding power against shock and vibration. The Bristol-originated Multiple-Spline socket allows these screws to be wrenched up exceptionally tight without danger of stripping the socket.

Bristol Multiple-Spline socket screws, both set and cap, are ideal for critical applications in aircraft, missiles and guidance equipment—like the famous NIKE (left)—communications and control equipment of all types—wherever ability to take extra wrenching torque is a factor.

Find out about them from your industrial distributor today.

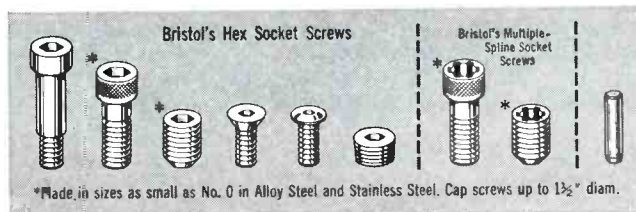

WRITE FOR complete information
... address requests for further data on any Bristol product to The Bristol Company, 152 Bristol Road, Waterbury 20, Connecticut.

7.30

BRISTOL Precision Products for Modern Manufacturing
AUTOMATIC CONTROLS • RECORDERS • TELEMETERS • SOCKET SCREWS
CHOPPERS AND HIGH-SPEED RELAYS • AIRCRAFT PRESSURE-OPERATED DEVICES

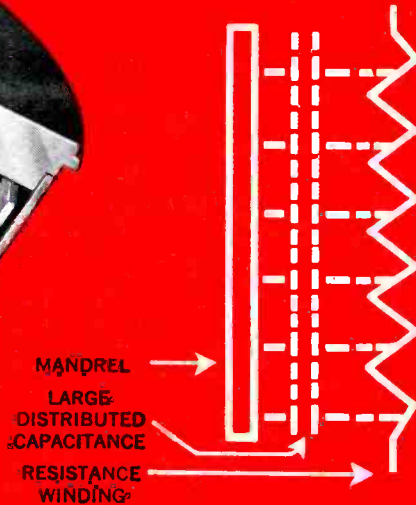
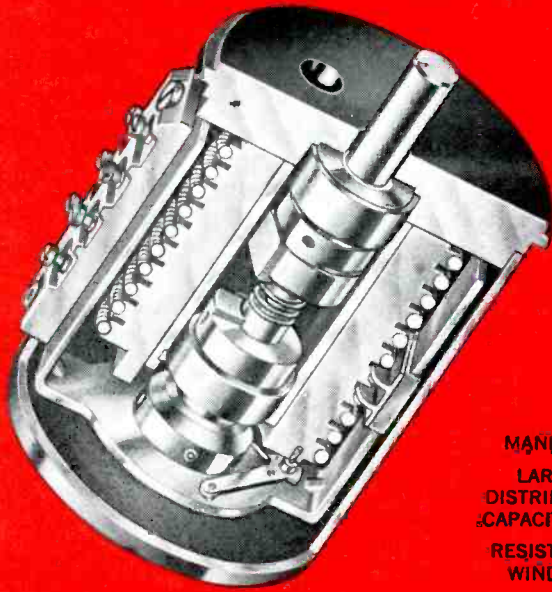

Phase Shift Compensation Eliminated In New HELIPOT® Precision Potentiometers

SPECIAL D-H ALLOYS MAKE AIR-CORE WINDINGS PRACTICAL!

Helipot's purpose in designing its new, air-core wound series 7700 Potentiometers was to make possible operation at higher frequencies with 0° phase shift—thereby eliminating compensation circuitry.

In nearly all multi-turn potentiometers, resistance wire is wound on an insulated copper-wire mandrel. This type of mandrel is used because it has uniform diameter, good heat conductivity and high thermal capacity. However, a disadvantage of such construction is the relatively large distributed capacitance between the resistance winding and the mandrel. When such a potentiometer is used as an AC voltage divider, the output generally differs in phase and magnitude from the desired output. This interferes with the effective use of high accuracy potentiometers unless compensation is applied somewhere in the circuit.

Helipot engineers desired to eliminate these problems by eliminating the copper-wire mandrel. But the elimination of the mandrel also

eliminated the support for the winding. Needed, therefore, was a type of wire that would make a self-supporting air-core winding.

At Helipot's request, Driver-Harris went to work with these specifications: The wire must be of dependable uniform hardness so that in stretching it, equal spacing between turns is obtained, free of creep. This is essential to linearity. The wire also must be of unvarying diameter for uniform resistance. And its surface must be extremely clean—free of oxide coating to minimize contact "noise".

Driver-Harris produced the wire—a special hard-drawn form of Karma* and Nichrome* V. And Helipot produced its new 10-turn series 7700 potentiometers in a resistance range from 200 to 5000 ohms. With this radically new air-core winding, linearity approaches the resolution of the unit without resort to padding or shunting. And phase shift in AC circuitry is reduced to less than 0.1°.

Since 1899, Driver-Harris has produced 132 special-purpose alloys in just this fashion—in answer to a particular problem and extraordinary specifications. If your own engineering and product development plans currently hinge upon a special alloy—why not bring your problem to Driver-Harris, Your inquiry is invited.

*T.M. REG. U.S. PAT. OFF.



Driver-Harris* Company

HARRISON, NEW JERSEY • BRANCHES: Chicago, Detroit, Cleveland, Louisville

Distributor: ANGUS-CAMPBELL, INC., Los Angeles, San Francisco

In Canada: The B. GREENING WIRE COMPANY, Ltd., Hamilton, Ontario

MAKERS OF THE MOST COMPLETE LINE OF ALLOYS FOR THE ELECTRICAL, ELECTRONIC, AND HEAT-TREATING INDUSTRIES

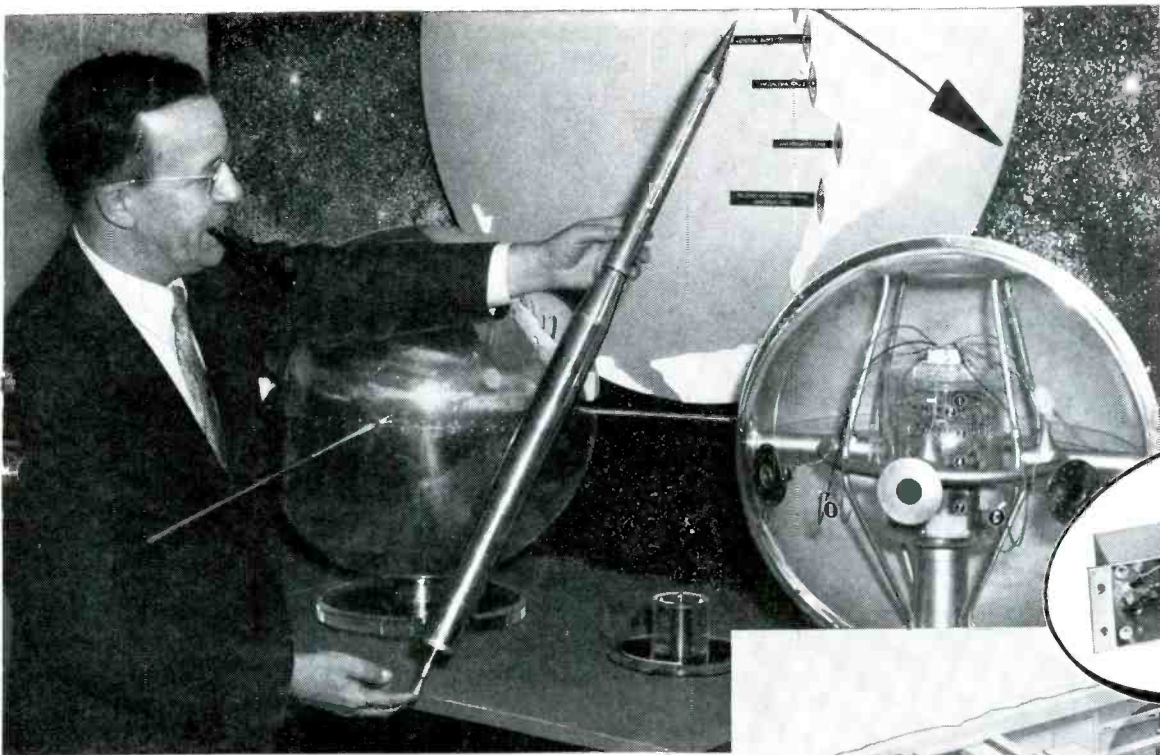

ABOVE: Dr. J. P. Hagen, Director of Project Vanguard, uses a model to illustrate the manner in which the satellite will be carried into its orbit. The earth satellite program is sponsored by the National Academy of Science and the National Science Foundation. Project Vanguard is the name assigned to the Department of Defense portion of the program. (Official United States Navy Photograph)

RIGHT: A cutaway view of a Minitrack mobile trailer housing equipment for tracking the satellite. Eight Minitrack receiver input strips are used in the receiver cabinet. Each strip receives a signal from one of eight antennas.

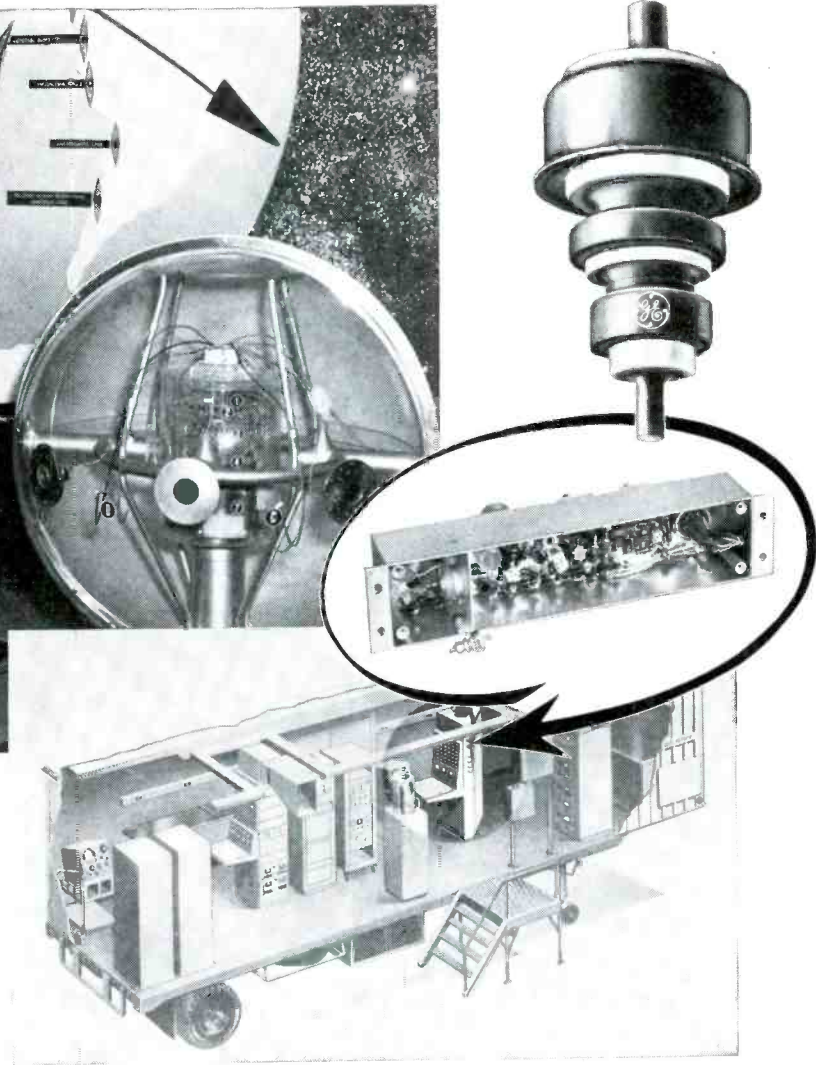

GL-6299 low-noise G-E triode is designer's choice for Minitrack System of tracking Earth Satellite



ACTUAL SIZE

When the satellite is launched in 1958 as part of a United States program for the International Geophysical Year, it will be followed in its orbit by a unique tracking system. This system, known as Minitrack, was designed by the U.S. Naval Research Laboratory and built by Bendix Radio Division, Bendix Aviation Corp. The system uses General Electric tube Type GL-6299 in a major role.

The tracking system consists of a transmitter in the satellite, and a series of receiving stations strategically placed to intercept the radio signals.

This transmitter will have an output power of as low as 10 milliwatts. Consequently, a circuit had to be designed to provide low-noise amplification of the signals. The low-noise G-E GL-6299 was picked for the R-F stage in this circuit because of its ability to provide sufficient power gain to prevent any significant contribution by the mixer stage to the over-all receiver output noise.

The designers of the Minitrack System took advantage of the tube's exceptionally low noise figure of only 2.5 db

at 108 mc. Additional advantages realized were receiver input strips with greater inherent stability, freedom from neutralizing requirements, and ease of alignment procedure.

Ratings of the GL-6299, based on performance results of the triode as a Class A₁ grounded-grid, coaxial-type RF amplifier with a 10-megacycle bandwidth include: a noise figure of 4 to 5 db at 400 mc.; 8 db at 1200 mc.; and less than 13.5 db at 3000 mc.; a gain of 17 db at 1200 mc. and 10 db at 3000 mc. Successful completion of extended life tests is responsible for the recent increase in tube warranty from 500 to 1000 hours, with no increase in price.

For detailed literature or application assistance, contact your regional power tube representative, or write to *Power Tube Department, General Electric Co., Schenectady, N. Y.*

Progress Is Our Most Important Product

GENERAL  ELECTRIC

9545-8481-4

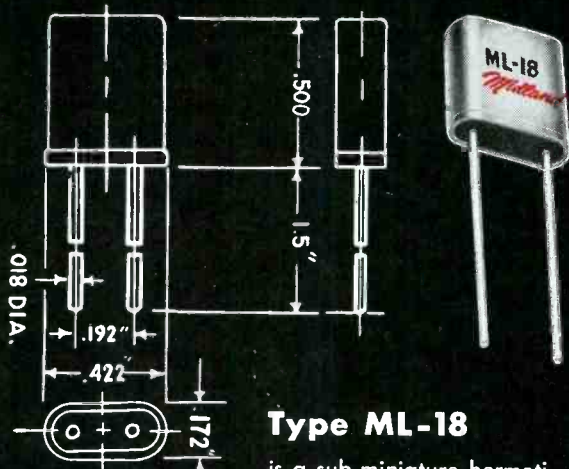

Wire pin diameter:
 $.017 \pm .001$
 Wire pin length:
 $1.500 \pm .062$
 Fixed pin diameter:
 $.040 \pm .002$
 Fixed pin length:
 $.224 \pm .030$

Type ML-18

is a sub-miniature hermetically sealed crystal unit with glass and metal base. Available with fixed pins or wire leads.

Range:
5.0 mc — 150.0 mc

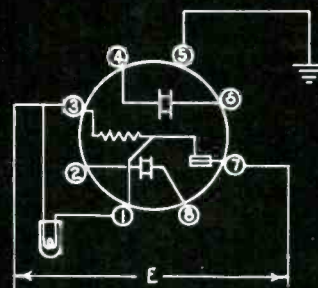
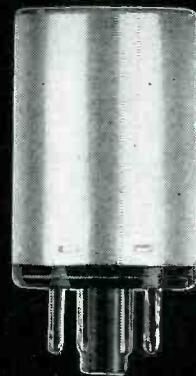

Standard Octal Base Crystal Oven for ML-6 or ML-13 crystal units: Oven accommodates one or two crystal units. Available in 1 3/4" or 2 1/2" tall can. Furnished in 6, 12, 27 or 115 volt. Temperature setting tolerance accurate to $\pm 1^\circ\text{C}$. Operative temperature calibrated at any desired temperature between 60°C and 100°C .

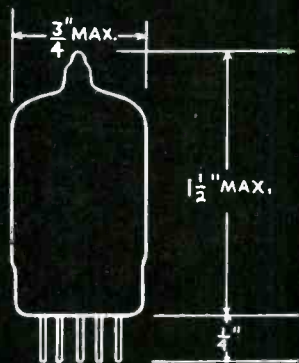

Pin diameter: $.040 \pm .002$
 Pin length: $.250 \pm .030$

Type ML-2G

a new all glass, 7-pin miniature.

Range:
200 kc — 150.0 mc

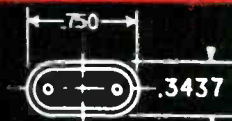

Pin diameter: $.050 \pm .002$
 Pin length: $.238 \pm .010$
 $-.015$

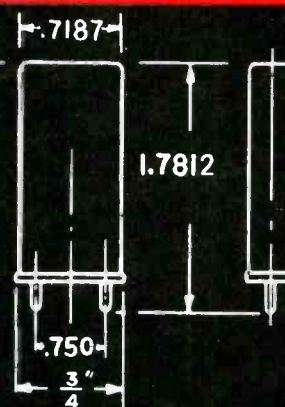
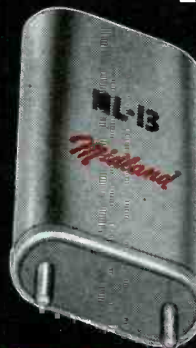

Type ML-13

Range: **4 kc — 300 kc**

This unit is hermetically sealed. The can is taller to accommodate the low frequency crystal blank.

**MORE HIGH QUALITY CRYSTALS
 HAVE BEEN PRODUCED BY Midland THAN
 BY ANY OTHER MAKER IN THE WORLD!**

When absolute accuracy in frequency control units must be rigidly maintained—entrust the job to Midland. You are assured of years of quality manufacturing experience plus constant advanced research in critical problems. Midland crystals used by the Military Services are consistently found to surpass military specifications in precise, constant and unflinching performance.

*Check with us on all your crystal needs...
 and any special requirements.*



Midland

MANUFACTURING COMPANY

3155 Fiberglas Road
 Kansas City 15, Kansas



New DC-to-25 MC DUAL-BEAM OSCILLOSCOPE

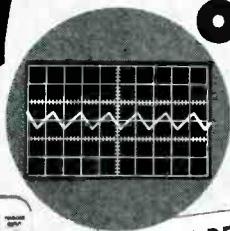

SINGLE-BEAM

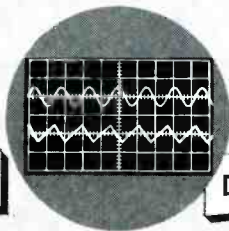

DUAL-BEAM

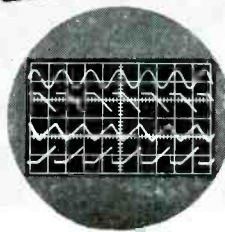

DUAL-BEAM
with dual-trace
on each beam.

TYPE 551

The new Tektronix dual-beam cathode-ray tube used in the Type 551 has two electron guns, each with a pair of vertical-deflection plates. A single pair of horizontal-deflection plates is common to both beams. The two wide-band main vertical amplifiers are designed for Type 53/54 Plug-In Pre-amplifiers, offering a high degree of signal-handling versatility in both channels. Both beams are simultaneously deflected at any one of the many sweep rates provided by an accurately-calibrated time-base generator.

The Type 551 can be used as a single-beam oscilloscope or as a dual-beam oscilloscope. In addition, a four-channel display is immediately available through the time-sharing characteristics of Type 53/54C Dual-Trace Plug-In Units . . . at passbands of dc to 22 mc. Other available Type 53/54 Plug-In Units extend the working range of the Type 551 into applications requiring high dc-coupled sensitivity, differential input, and narrow-band microvolt sensitivity.

Price, without plug-in units **\$1725**
 Type 500/53 Scope-Mobile **\$108**
 Type 53/54K
 Fast-Rise Plug-In Pre-amplifiers,
 each **\$125**
 Type 53/54C
 Dual-Trace Plug-In Pre-amplifiers,
 each **\$275**
 Prices f.o.b. Portland, Oregon



CHARACTERISTICS

WIDE-BAND VERTICAL AMPLIFIERS

Main-unit vertical-amplifier risetimes — 0.012 μ sec. Balanced delay lines, signal delay 0.2 μ sec each amplifier.

Characteristics with Type 53/54K Plug-In Units

Risetimes — 0.014 μ sec.
 Passbands — dc to 25 mc.
 Deflection factors — 0.05 v/cm. 9 calibrated steps from 0.05 to 20 v/cm.

Characteristics with Type 53/54C Plug-In Units

Risetimes — 0.016 μ sec.
 Passbands — dc to 22 mc.
 Deflection factors — 0.05 v/cm. 9 calibrated steps from 0.05 to 20 v/cm.
 All Type 53/54 Plug-In Units can be used with the Type 551.

WIDE-RANGE SWEEP CIRCUIT

24 accurately-calibrated sweep rates from 0.1 μ sec/cm to 5 sec/cm.

5X magnifier is accurate at all sweep rates. Variable control provides for continuous adjustment from 0.02 μ sec/cm to 12 sec/cm.

Single Sweep — lockout provision prevents further triggering after a single sweep . . . for transient photography.

Versatile Triggering — from either channel internally or from an external signal, or from the line voltage. Triggering from the positive or negative slope of the triggering signal, ac or dc-coupled, with an ac-coupled position that rejects low frequencies. Automatic triggering, amplitude-level selection with preset or manual stability control, and high-frequency sync.

OTHER CHARACTERISTICS

Square wave amplitude calibrator, 0.2 mv to 100 v, frequency about 1 kc.

Separate power supply, electronically regulated.

10-kv accelerating potential on new Tektronix dual-beam crt. 6-cm by 10-cm linear display area. (4-cm by 10-cm each beam).

Beam-position indicators for both beams.

ENGINEERS—interested in furthering the advancement of the oscilloscope? We have openings for men with creative design ability. Please write Richard Ropiequet, V-Pres., Engineering.

Tektronix, Inc.

P. O. Box 831 • Portland 7, Oregon

Phone CYPRESS 2-2611 • TWX-PD 311 • Cable: TEKTRONIX

Regular shipments of the Type 551 are expected to begin during January, 1958. However, your Tektronix Field Engineer or Representative quite likely will be able to arrange a demonstration somewhat sooner. Please keep in touch with him for current details.

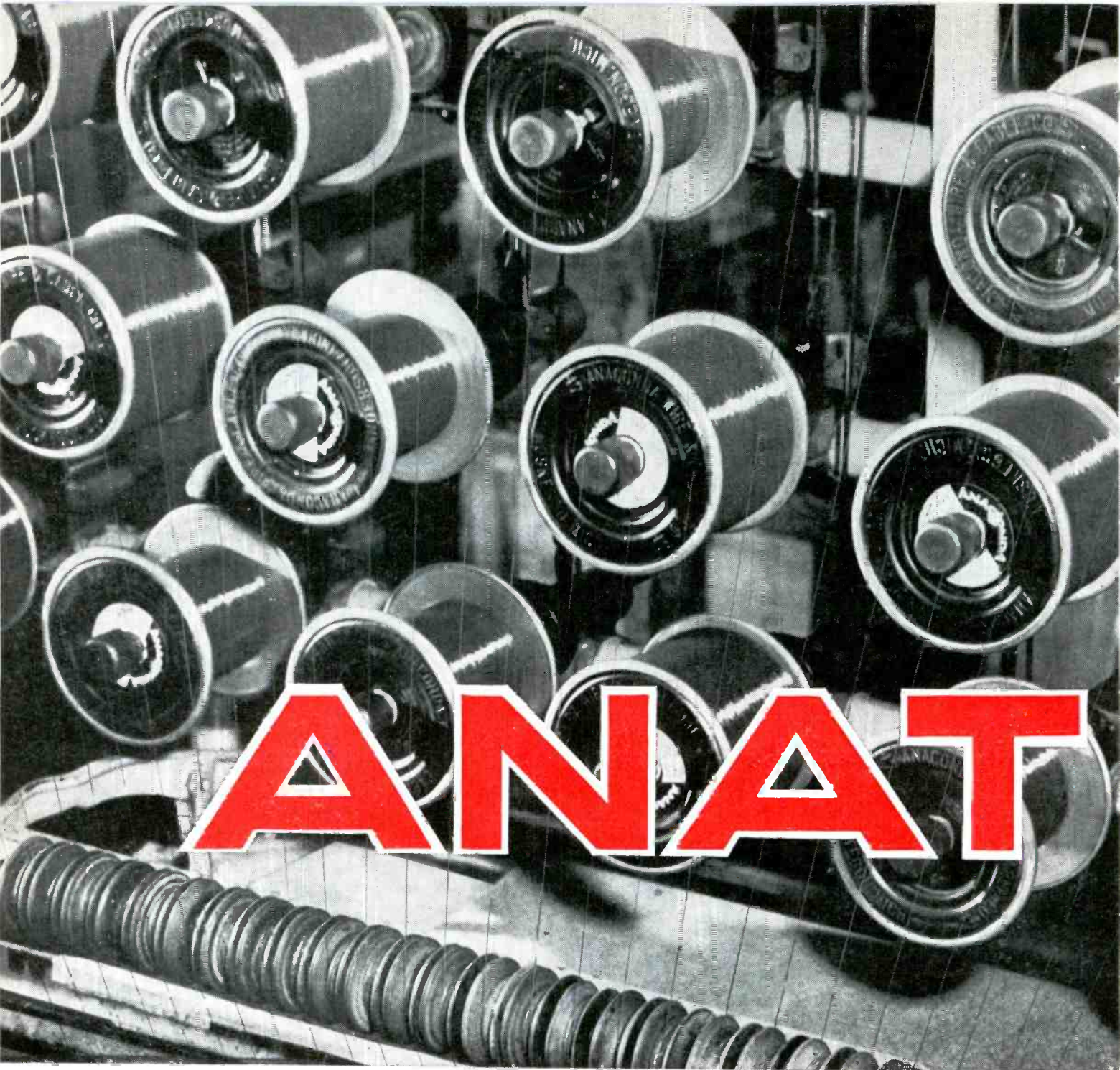

ANAT

Now—the first 155°C (Class F) magnet wire designed

Another Anaconda first! Anatherm—a new polyester film-coated magnet wire—fully tested for use at “hottest-spot” temperatures up to 155°C. With this new higher level of thermal stability, Anaconda Anatherm is the first film-coated wire to meet the newly adopted AIEE 155°C (Class F) rating!

Greater thermal stability—plus excellent

abrasion-resistance characteristics, chemical stability and dielectric strength—makes Anatherm ideally suited for manufacturers seeking maximum performance and reliability from smaller and smaller equipment operating at higher and higher temperatures.

As a polyester magnet wire, Anatherm can be used equally successfully at any hottest-spot

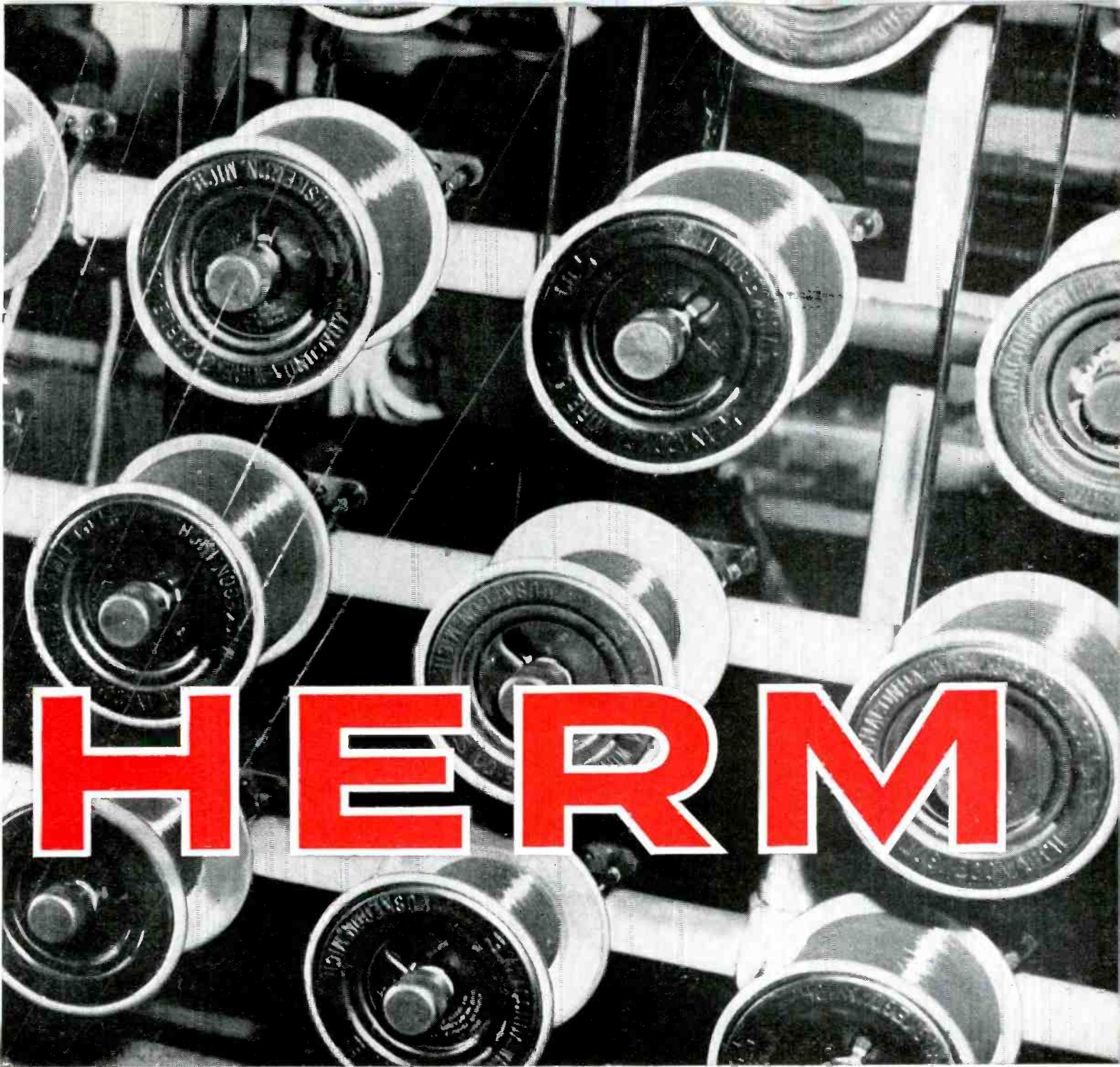

HERM

**polyester film-coated
to meet new AIEE requirements**

temperature over the range of 105°C to 155°C.

Available in single and heavy film thickness
in AWG sizes from 15 through 25.



Free Technical Bulletin on Anatherm Magnet Wire is available. Simply write: Anaconda Wire & Cable Company, 25 Broadway, New York 4, N. Y. 57373

ASK THE MAN FROM **ANACONDA**[®]
ABOUT **ANATHERM MAGNET WIRE**



TAYLOR

Laminated Plastics
Vulcanized Fibre

Shop Talk

TAYLOR FIBRE CO.

Plants in Norristown, Pa. and La Verne, Calif.

PHENOLIC—MELAMINE—SILICONE—EPOXY LAMINATES • COMBINATION LAMINATES • COPPER-CLAD LAMINATES • VULCANIZED FIBRE

Tips for designers

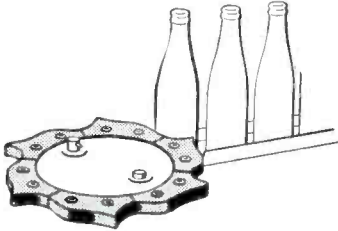

Indexing cams to position bottles under filling machines are made of Taylor Grade CEF phenolic laminate . . . replacing metal cams, they save money by reducing bottle breakage, avoiding rust.

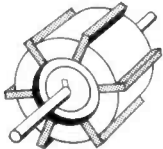

Gas pump impeller unit is fabricated of Taylor Grade LE-6 phenolic laminate . . . economical, light-weight, wear-resistant . . . chosen because of strength, stability.

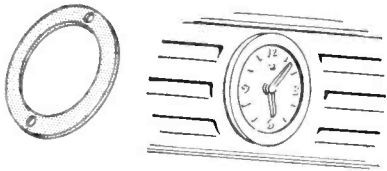

Automobile clock is securely and economically mounted on inside surface of metal dashboard, with a spacer fabricated from Taylor vulcanized fibre.

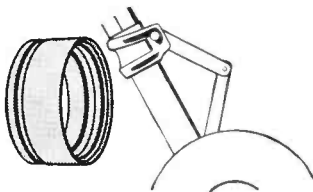

Aircraft landing gear bearings are fabricated of Taylor Grade LE-6 cotton base phenolic laminate to meet requirements of dimensional stability, wear resistance and low moisture absorption.

TAYLOR'S NEW COPPER-CLAD LAMINATE Cu-246

...is now available for your volume production of printed circuits. High purity rolled copper surface is adaptable for all circuit production methods. Cu-246 is produced in all standard sheet sizes . . . in thicknesses from .020" to .250".

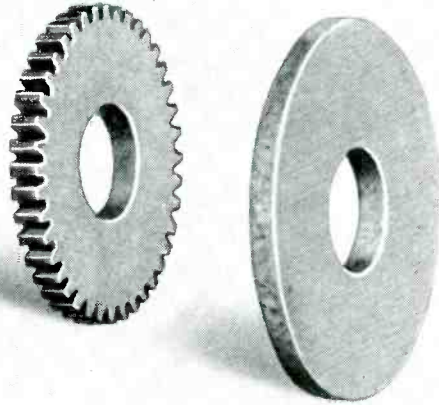

Special purpose gear is fabricated of Taylor Grade CEF phenolic laminate for Hadley Gear Mfg. Co. Taylor punches the gear blank to an I.D. tolerance of $\pm .001$ " . . . material was selected for its excellent punchability, good machineability, moisture resistance and impact strength.

Taylor delivers precision parts . . . geared to your production schedule

The inside diameter of this gear blank was punched to a tolerance of $\pm .001$ " by Taylor's Fabrication Division—an example of the close tolerances which Taylor can meet. Taylor has special techniques and facilities for handling this type of work—acquired through years of experience in fabricating all kinds of laminates.

Taylor Grade CEF phenolic laminate was selected as the material for the gear blank—to take advantage of this laminate's excellent punchability and machineability as well as its moisture resistance and impact strength.

You can put Taylor's facilities and techniques to work improving your product. Taylor can deliver precision parts, such as this gear blank, fabricated to your most exacting specifications . . . geared to meet your production schedule.

When you have a problem of material selection or close-tolerance fabrication, or product design, check with Taylor. Chances are that Taylor's staff of home and field office specialists can help you in any or all of these essentials to a good product. Call or write your nearest Taylor sales office for a discussion of your requirements.

Electron Tube News

- from SYLVANIA

Creating New Design Trends—Everywhere in Electronics

IN 110° PICTURE TUBES . . .

Sylvania goes into production on the 24AMP4, a 24-inch 110° picture tube that fosters new concepts in set design

In 24-inch tubes—Sylvania applies the 110-degree deflection design to 24-inch picture tubes. The result is a tube 6" wider than it is long. The new dimension permits interesting new concepts in TV chassis design as well as in cabinet styling. The new 24AMP4 presents a new opportunity for TV receiver manufacturers to score again with 110-degree TV sets.

The new 110° 24-inch tube weighs 26.5 pounds, some 6 pounds less than its 90° predecessors. It measures 15 $\frac{5}{8}$ inches in length, 3 $\frac{1}{2}$ inches shorter than 24", short neck, 90° tubes. Useful width is 21 $\frac{3}{8}$ inches. Picture area is approximately 332 square inches. It does not require an ion trap. The 24AMP4 employs a 6.3 V., 600 ma. heater and external conductive coating is rated at 2000 to 2500 uuf.

In 21-inch tubes—Sylvania continues to lead the way in 110-degree, 21-inch picture tubes with the 21CQP4, the

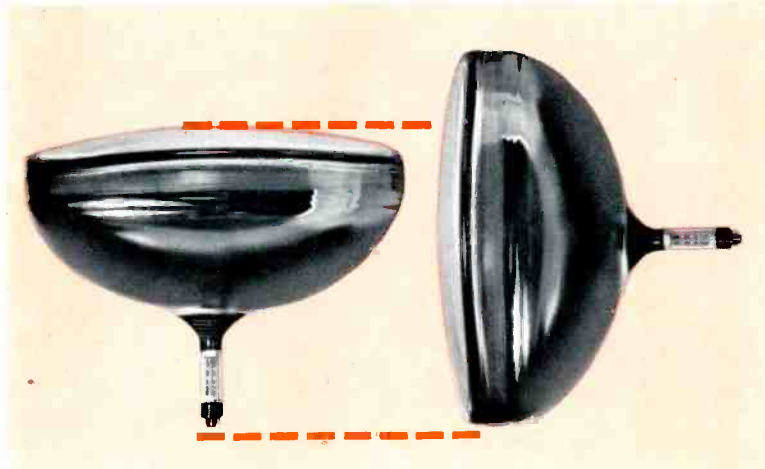

Sylvania's new 24-inch 110° picture tube, type 24AMP4, is 6 inches wider than long

shortest 21-inch picture tube on the market. The tube measures 14 $\frac{7}{8}$ inches in overall length and weighs 20 pounds. The new shorter length in this Sylvania original is made possible by the new non-ion trap gun with electrostatic focus that reduces tube length up to a full inch.

IN CATHODE-RAY TUBE DESIGN

Sylvania develops a 450 ma. 6.3 volt heater for "cooler" TV receivers using series string heaters

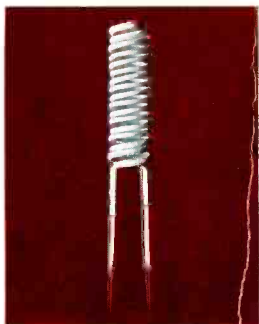

New heater uses straight tungsten wire

- Double helical coil is wound from straight rather than a coiled tungsten wire as in other 450 ma. heaters.
- Rigid mechanical structure virtually eliminates tendency of heater to sag away from cathode cap and cause slow heating and low emission.

Following are the Sylvania tube types that employ the new heater design:

In 90° tubes—14XP4, 14XP4A, 17BKP4, 17BKP4A, 17BSP4, 17CEP4, 21CDP4, 21CDP4A, 21CKP4.

In 110° tubes—17BYP4, 21CSP4.

Sylvania, trend setter in electron-tube design, has developed a 450 ma., 6.3 volt heater for picture tubes. The new heater meets the needs of portable TV receiver designs and lowers component costs. It reduces heat with total set power savings of 18 watts and permits use of a lower wattage, less expensive series resistor.

Here are some of the outstanding features of the new heater development:

IN SPECIAL CR TUBES . . .

Sylvania expands its line of cathode-ray tubes for commercial and military use

Sylvania announces an expanded line of cathode-ray tubes for both military and commercial applications. The additional types now or soon available include the 3JP7, 7AB series, 5AHP4A and 5AHP7A, 10WP7, 12SP7D, 5UP1 and 3RP1.

Sylvania is also now featuring its line of conventional and special picture tubes for studio monitors and closed circuit TV. The types range in size from 8 inches through 24 inches.

The entire Sylvania cathode-ray tube line incorporates electron guns with more precise parts made to 50 percent closer tolerances. This assures better performance and longer life whatever the application.

Sylvania's 7ABP7A-cathode-ray tube



Creating New Design Trends—

IN 100% TUBE TESTING . . .

Sylvania develops new automation equipment that makes possible full five-minute pre-heat testing of every receiving tube it makes

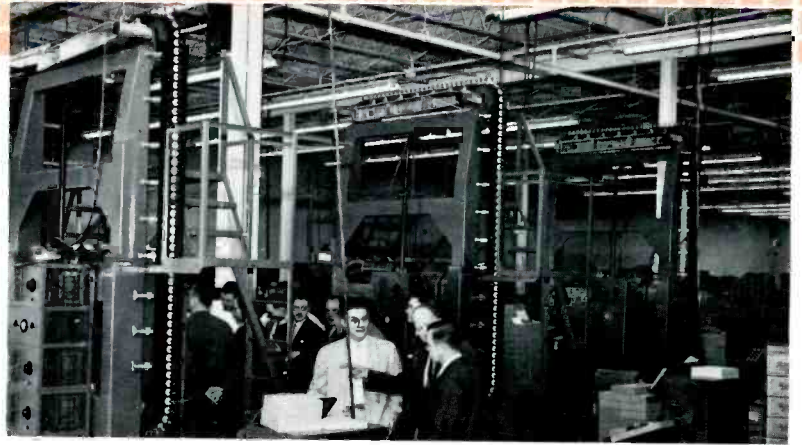

Sylvania customers view giant automatic tube tester

Sylvania now subjects each and every receiving tube it manufactures to an automatic five-minute pre-heat and tapping test. This gives added protection against shorts, noise, gas and other tube defects and reduces rejects on receiver-assembly lines.

At Sylvania's Williamsport plant,

the giant machines shown, designed and built under the direction of Sylvania engineers, do the testing automatically. The tubes are loaded on a continuously rotating conveyor belt. Before the belt journey is completed, every tube is subjected to the pre-heat and tapping test. Then the

tubes are automatically repacked for shipment.

This final extensive and intensive quality program at Williamsport combined with testing activities at each individual receiving-tube plant are reasons behind the high quality of Sylvania tubes.

IN TELEVISION . . .

Sylvania 6CK4—New Low-Mu Triode for Vertical Deflection Amplifier Service

Sylvania type 6CK4 is a low-mu triode designed for service as a vertical deflection amplifier in TV sets featuring wide-angle picture tubes and high cathode-ray tube accelerating potential.

Design factors including a T6 bulb provide a safety factor for conservative, reliable operation in such applications.

Ratings of type 6CK4 include 2,000 volts peak positive plate, a plate dissipation of 12 watts, and an average cathode current of 100 ma.

Average Characteristics:

Plate Voltage	250 Volts
Grid No. 1 Voltage	-26 Volts
Plate Current	55 ma.
Transconductance	6500 UMHOS
Amplification Factor	6.7
Plate Resistance (Approx.)	1,000 OHMS
Grid Voltage for IB equals 0.5 ma.	-50 Volts
Plate Current at EC equals -38 VDC.	10 ma.
Zero Bias Plate Current: EB equals 100V, EC equals 0 (instantaneous values)	125 ma.

New 110-degree damper types, 6DA4 and 12D4, have high peak current

Sylvania's new 110-degree damper types 6DA4 and 12D4 feature high peak current capabilities, low tube drop and adequate peak inverse plate voltage rating to make it a most desirable damper for 110° deflection. The 12D4 is a half wave rectifier for 600 ma series string usage. It is the 12-volt version of the 6DA4.

Maximum Ratings (Design Maximum System)

Peak inverse plate voltage	4400 volts
Plate dissipation	5.5 watts
Steady state peak current	900 ma.
Average plate current	155 ma.
Tube voltage drop for IB-250 ma.	20 volts

Sylvania introduces the 6/8CY7 as a combined vertical deflection oscillator and amplifier in TV receivers

Sylvania adds the 6/8CY7 to its TV tube line as a supplement to the 10DE7. The new tube combines two dissimilar triodes in one T6½ envelope for use in 90-degree short neck picture tube circuits. The oscillator section features a high mu triode.

Maximum Ratings

	Oscillator Section 1.0 watts	Output Section
Plate dissipation	—	5.54 watts
Peak-positive pulse plate voltage	—	1800 volts
Peak cathode current	—	120 ma.
Average cathode current	—	35 ma.



Everywhere in Electronics

IN TV LIFE TESTING RESULTS...

Percentage of Sylvania TV receiving tube complements surviving 1500 hours has tripled since 1954

Today Sylvania TV receiving tubes are setting new records in life tests. The percentage of TV tube complements surviving 1500 hours of operation at high line conditions has tripled since 1954 and is now at the highest rate in Sylvania history. This means assurance of a better field history as well as substantial savings in line operations for receiver manufacturers.

The overall survival rate for Sylvania TV receiver tubes has increased steadily through the years. In the past year alone there has been an average increase of 15 percent in TV tube complement survival. This represents

the largest increase since 1953 and is a combined achievement of Sylvania's Dynamic Testing Program and better TV circuit design. Under the Dynamic Testing Program, individual Sylvania receiving tube types are evaluated in actual circuit environments in current TV set designs. Sylvania's Joint Engineering and Manufacturing Committee, JEMC, meets weekly to keep testing specs current. This kind of extraordinary care for receiving-tube quality is why Sylvania tubes last longer.

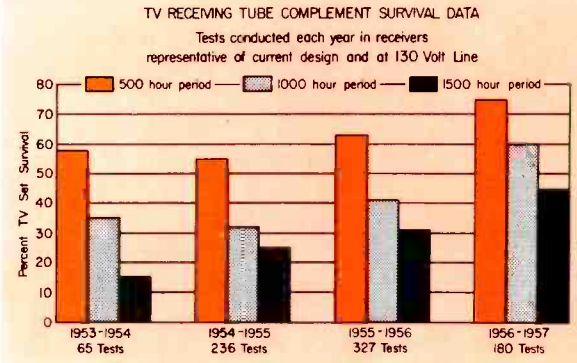

Increasing life of Sylvania tubes is a combined achievement of the Dynamic Testing Program and refinements in TV circuit design for better reliability

IN PROCESS CONTROL...

Sylvania uses an electronic micrometer to control filament coating thickness

Precise control of heater wire coating is of paramount importance in producing top-quality electron tubes. Proper coating means longer tube life and higher emission.

Sylvania controls filament coating thickness to the most exacting tolerances with an electronic micrometer.

The photoelectric device constantly monitors the coating process and registers thickness on electric meters. It immediately detects any thickness deviations and automatically stains the improperly coated heater wire with colored dye. The material can then be easily identified and rejected.

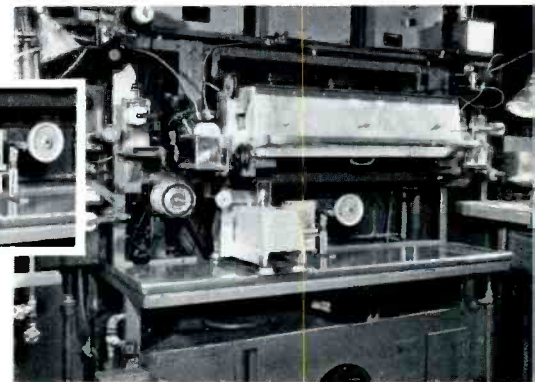
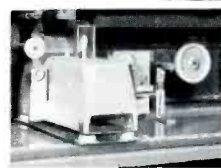

Sylvania's electronic micrometer automatically controls filament coating thickness. It automatically stains improperly coated heater wire with colored dye

IN AUDIO TYPES...

New audio power pentode, type 6BQ5, has high sensitivity

Now Sylvania offers its version of one of the world's finest high-fidelity audio power amplifier tubes. Type 6BQ5 features high power output at extremely low distortion.

The high power sensitivity of type 6BQ5 makes it especially attractive.

The T6½ bulb used by this type is a desirable feature in compact high-fidelity equipment.



Postage
Will be Paid
by
Addressee

No
Postage Stamp
Necessary
if Mailed in the
United States

BUSINESS REPLY CARD
(First Class Permit No. 46687, New York 19, N. Y.)

SYLVANIA ELECTRIC PRODUCTS INC.
1740 Broadway
New York 19, N. Y.



Creating New Design Trends— —Everywhere in Electronics

IN COMPUTER TUBES...

Sylvania expands the availability of types 5963 and 5964 to meet rising computer demands

Now Sylvania is ready to meet fully the heavy demands from electronic computer manufacturers for types 5963 and 5964.

Type 5963 is a T6½ duotriode featuring high zero bias plate current. The tube is used as a frequency divider as well as in computers.

It performs dependably in intermittent operation. The sharp cut-off twin

triode has individual cathode connections for separate operation of each section. It has a center tapped heater for 6.2 or 12.6 volt operation.

Type 5964 is a T5½ duotriode also featuring high zero bias plate current as in the 5963. The medium mu twin triode maintains its emission capabilities for long periods of operation under cut-off conditions.



Type 5963	Computer Service	
	Cutoff Conditions	Zero Bias Conditions
Plate Supply Voltage	150 volts	150 volts
Grid Voltage	-15 volts	0 volts
Plate Circuit Resistance	20,000 ohms	20,000 ohms
Grid Circuit Resistance	47,000 ohms	47,000 ohms
Plate Current	0	5.1 ma.
Type 5964		
Plate Supply Voltage	150 volts	150 volts
Grid Voltage	-10 volts	0 volts
Plate Circuit Resistance	20,000 ohms	20,000 ohms
Grid Circuit Resistance	47,000 ohms	47,000 ohms
Plate Current	0	5 ma.

IN GUIDED MISSILE TYPES...

Sylvania builds its new guided missile line to meet the most severe requirements

Despite new extremes in heat, shock and vibration as today's missiles fly

higher and faster, Sylvania's guided missile line is meeting top performance standards.

Behind this outstanding record stands one of the most comprehensive tube developmental programs in the industry. It incorporates radical new tube designs, new materials and techniques to offer the most reliable tubes obtainable today for missile service.

Sylvania now has the following guided missile types available:

Type No.	Description
6943	Sharp cutoff RF pentode
6944	Semi-remote cutoff RF pentode
6788	Pentode audio voltage amplifier
6945	Audio beam power pentode
6946	Medium mu single triode
6947	Double, medium mu triode
6948	Double, high mu triode

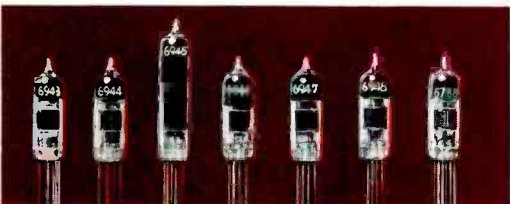

SYLVANIA

Please send additional information on the items checked below.

- | | |
|---|--|
| <input type="checkbox"/> Type 24AMP4 | <input type="checkbox"/> Types 6DA4 and 12D4 |
| <input type="checkbox"/> Type 21CQP4 | <input type="checkbox"/> Type 6/8CY7 |
| <input type="checkbox"/> 450 ma. 6.3 v Heater Picture Tubes | <input type="checkbox"/> Type 6BQ5 |
| <input type="checkbox"/> Special Purpose C-R Tubes | <input type="checkbox"/> Types 5963 and 5964 |
| <input type="checkbox"/> Type 6CK4 | <input type="checkbox"/> Guided Missile Line |

Name _____

Address _____

Company _____

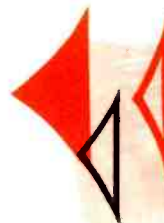

**Use this handy
business reply card
to request
additional information
on these important new
Sylvania developments**

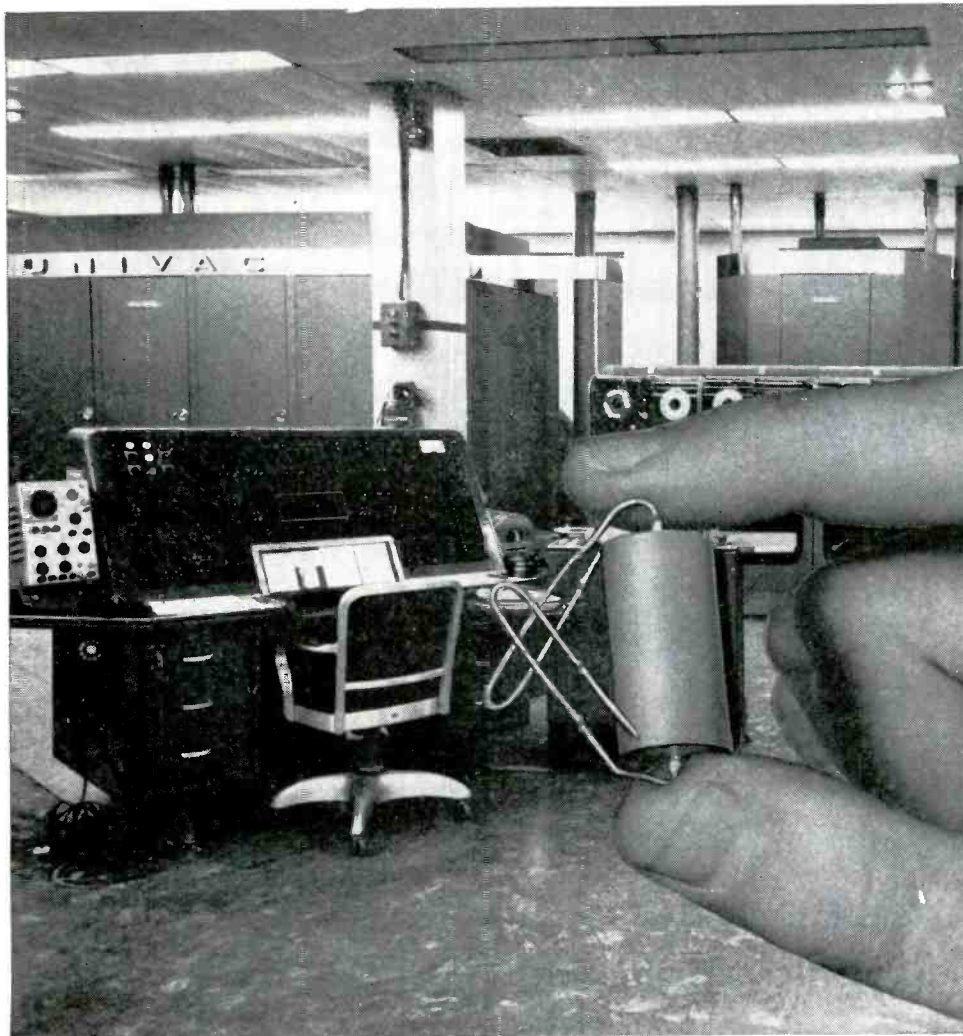

"MYLAR" offers a unique combination of properties valuable for electrical design



HIGH TENSILE STRENGTH. "Mylar" is the strongest plastic film. Instron tester shows an average strength of 20,000 lbs. psi.

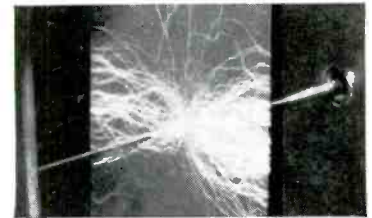

HIGH DIELECTRIC STRENGTH. Average of 4,000 volts per mil . . . average power factor of 0.003 at 60 cycles . . . dielectric constant above 3.0 at 72°F., 1,000 cycles.

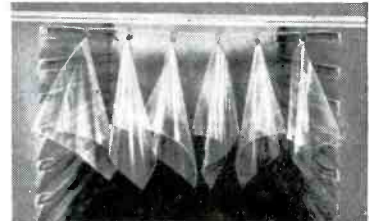

THERMAL STABILITY. Tests prove "Mylar" has an effective operating range, -80°F. to 300°F. . . won't brittle with age.

TESTS BY REMINGTON RAND PROVE . . .

Du Pont MYLAR[®] provides greater reliability, longer life for capacitors used in Univac[®]

PROBLEM: The Remington Rand Division of the Sperry Rand Corp. had to find a capacitor of high reliability that could meet the requirements of extra-sensitive circuits found in UNIVAC* Data Automation Systems.

SOLUTION: In a series of accelerated tests by Remington Rand, various types of capacitors were exposed to conditions more exacting than those found in normal operation of UNIVAC

Systems. These tests proved that capacitors made with "Mylar"† polyester film offered greater reliability and longer life, with an extra margin of safety in moisture resistance. The tests documented the fact that "Mylar" provides excellent insulation resistance at high temperatures . . . "Mylar" does not deteriorate with age or voltage stresses within normal operating ranges.

RESULTS: By using capacitors made with "Mylar", Remington Rand has

improved the performance of another component in UNIVAC Systems . . . has helped improve the performance of UNIVAC Systems themselves.

HOW CAN "MYLAR" HELP YOU? Whether you make guided missiles or tiny components, it will pay you to investigate the unique advantages of using "Mylar" film . . . or products made with "Mylar". Send for a copy of our new booklet containing detailed information on properties and applications.



BETTER THINGS FOR BETTER LIVING
... THROUGH CHEMISTRY

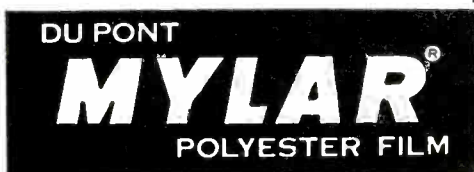

*UNIVAC is a registered trademark of Sperry Rand Corporation.
†"MYLAR" is Du Pont's registered trademark for its brand of polyester film.

E. I. du Pont de Nemours & Co. (Inc.)
Film Dept., Room E-11, Wilmington 98, Del.

Please send your booklet listing properties, applications and types of "Mylar" polyester film available (MB-11).

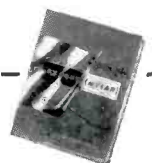

Application _____
Name _____ Title _____
Company _____
Address _____
City _____ State _____

Specify COILED CORDS

...add important convenience and safety features to your equipment!

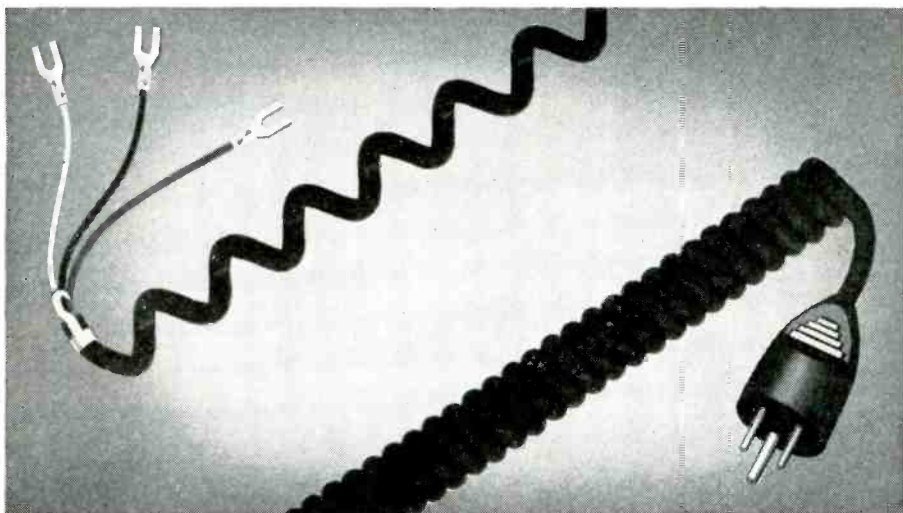

Cords Limited COILED CORDS are engineered for specific application!

Coiled Cords, first choice in the communications industry, find numerous important applications in other fields! In addition to user convenience, Cords Ltd. Coiled Cords provide a safety factor preventing costly industrial accidents. Maintenance-wise, Coiled Cords give much longer service than straight cords by eliminating common abuses that shorten serviceability.

Product Data: A leader in the development of Coiled Cords, Cords Limited is a major supplier of this product to the telephone and communication industries. Coiled Cords are engineered for specific applications. Special oil, acid and moisture resistant properties of the jackets protect the product under unusual conditions. The most modern molding facilities for plug and conductor termination are available at Cords Limited to serve your needs quickly and economically!

WRITE TODAY for complete details... your quotation requests will receive immediate attention!



CORDS LIMITED DIVISION
ESSEX WIRE CORPORATION
 DeKalb, Illinois

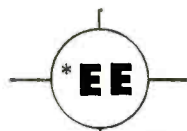

other outstanding
***ESSEX ENGINEERED**
production proven products

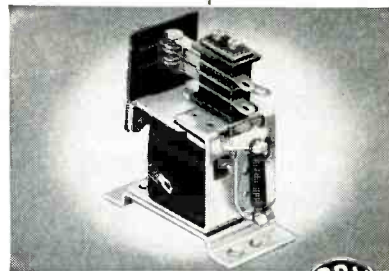

GENERAL PURPOSE RELAYS

A.C. or D.C. General Purpose Multipole relays. For circuit switching of electrical interlocking remote control devices. Features special cross-bar contacts for low-voltage, low current circuits or button type contacts for power switching circuits. Request Bulletin No. 1060.

R-B-M "Control" Division
 Logansport, Indiana

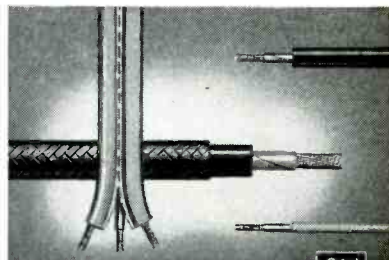

WIRE AND CABLE

A full "Extra Test" line of lead, appliance, automotive and refrigeration wires, plus submersible pump cable and 200° C. Sil-X insulations are examples of the versatility of "Essex Engineering".

Wire and Cable Division
 Fort Wayne, Indiana

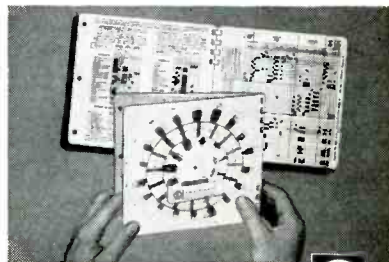

CORD SET DESIGN AID

The CORDINATOR, a time-saving engineering tool, features simplified charts showing approved wire by product types. Dial side permits visual fabrication of cord sets and power supply cords. All components standard approved... minimizing cost... assuring scheduled delivery. Write for your free CORDINATOR.

Cords Limited Division
 DeKalb, Illinois



Now...a battery of
Hydroforms at

kaupp



8-INCH HYDROFORM
Maximum Blank — 8" Diameter
Maximum Draw Depth — 5"

— to reduce your development time and
costs on every pre-production run!

Kaupp hydroformed prototypes and pre-production parts are accurately formed and drawn in less time, at lower cost. Hydroforming produces short run, and in some cases production pieces, quicker and more economically than tool and die methods. New equipment installed by Kaupp assures faster service. For complete information on Kaupp metal forming facilities, call or write today!

- FEWER DRAWING OPERATIONS
- SIMPLER TOOLING
- FASTER SET-UP
- IMPROVED QUALITY

Expanded Kaupp facilities include deep drawing by conventional methods for volume production runs and a completely equipped metal spinning department.



19-INCH HYDROFORM
Maximum Blank
19" Diameter
Maximum Draw
Depth — 8"

Specify

KAUPP...

for Accurate Forming and Drawing of Stainless Steel, Inconel, Cold Rolled Steel, Aluminum, Copper, Brass and Other Alloys

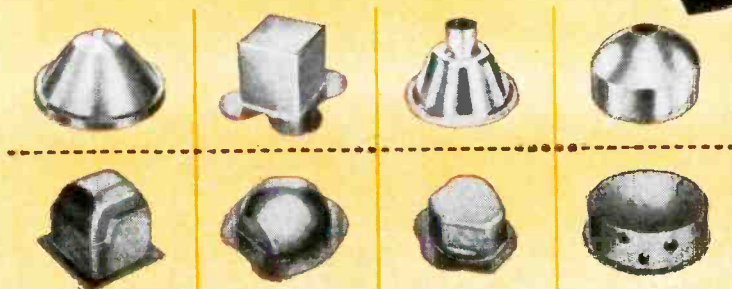

C. B. KAUPP & SONS

NEWARK WAY • MAPLEWOOD
NEW JERSEY

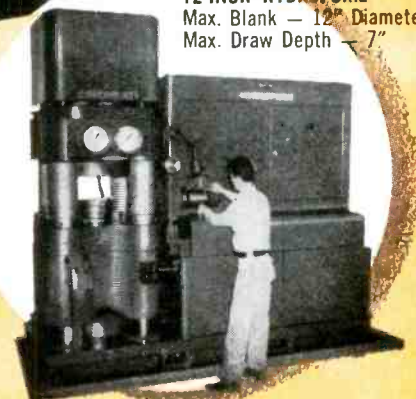

12-INCH HYDROFORM
Max. Blank — 12" Diameter
Max. Draw Depth — 7"



Now!

New low cost oscillator covers entire audio band in one sweep of the dial

-hp- 207A Audio Sweep Oscillator— continuous output 20 cps to 20 KC— flat response, low distortion— may be motor driven or coupled to recording device

SPECIFICATIONS

Frequency Range:

20 cps to 20 KC, covered in one range.

Accuracy:

±4% including changes due to warm-up, aging components, tubes, etc.

Dial:

Six-inch diameter dial calibrated over 300° of arc.

Frequency Response:

±1 db entire frequency range.

External Frequency Control:

¼-inch shaft, extending from rear of instrument, rotation approximately 150° for full frequency coverage.

Output:

10 volts into 600 ohm rated load, balanced or 1 terminal at ground.

Output Control:

Decreases level continuously by more than 40 db.

Distortion:

Less than 1% over entire frequency range.

Hum Voltage:

Less than 0.1% of rated output. Decreases as output is attenuated.

Power:

115/230 volts, ±10%, 75 watts.

Dimensions:

Cabinet Mount: 7½" wide, 11½" high, 15¼" deep. Rack Mount: 19" wide, 7" high, 12½" deep.

Weight:

Approximately 25 lbs.

Price:

\$275.00

Data subject to change without notice

Here at last is a low cost, high quality oscillator providing the time-saving convenience of continuous single-sweep frequency coverage from 20 cps to 20 KC. The instrument has high waveform purity, constant output, high stability and dial calibration which is essentially logarithmic. Band switching and resulting transients are eliminated. A flexible 10 volt output can be used balanced or with one side grounded.

Model 207A may be swept by hand, motor driven, tuned remotely or coupled to a recording device by means of a shaft extended through the rear of the cabinet.

Priced at just \$275.00, this new -hp- oscillator is an outstanding value and particularly convenient for such audio tests as speaker frequency response and amplifier flatness, measuring characteristics of filter networks, complex coupled systems and industrial transducers, or automatic response measurements where response is recorded or viewed on an oscilloscope.



650A — highly stable, wide band; 10 cps to 10 MC. For audio, supersonic, video, rf measurements. Output 15 mw/3 volts. Frequency response flat ± 1 db. \$490.00.



200AB — for audio tests, 20 cps to 40 KC. Output 1 watt/24.5 volts. Simple to use, compact, rugged. \$130.00.

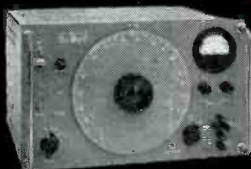

233A — carrier test oscillator covering frequencies 50 cps to 500 KC. Output 3 watts/500 ohms. \$475.00.

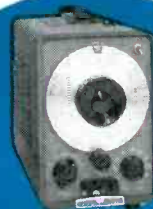

200CD — popular precision instrument for audio and ultrasonic tests. 5 cps to 600 KC; output 160 mw/10 volts; 20 volts open circuit. \$160.00.

11

**additional
-hp- quality oscillators**



206A — very low distortion; for high quality, high accuracy audio tests. Covers 20 cps to 20 KC; output +15 dbm. \$565.00.

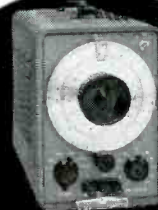

200J — extreme accuracy for interpolation and frequency measurements. Covers 6 cps to 6 KC, output 160 mw/10 volts; 20 volts open circuit. \$275.00.

- outstanding value
- complete coverage
0.008 cps to 10 MC
- stable RC circuit pioneered by -hp-

- each instrument designed to do a specific job best

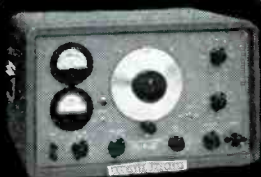

205AG — time-tested convenience for high power tests, gain measurements. 20 cps to 20 KC, 5 watts output. \$440.00.



200T — custom-engineered for telemetry, carrier current tests. 250 cps to 100 KC, output 160 mw/10 volts; 20 volts open circuit. \$350.00.

HEWLETT-PACKARD COMPANY

4170A Page Mill Rd., Palo Alto, Calif., U.S.A.
Cable "HEWPACK" • DAVenport 5-4451
Field engineers in all principal areas



World's most complete line of fast, accurate, easy to use oscillators!



202C — replaces famous 202B for low frequency measurements 1 cps to 100 KC. Output 160 mw/10 volts; 20 volts open circuit. \$300.00.



202A — for servo, vibration, medical and other very low frequency measurements. 0.008 to 1,200 cps. Output 20 mw/10 volts. \$465.00.



201C — specifically designed for high quality audio tests. Covers 20 cps to 20 KC. Output 3 watts/42.5 volts. \$225.00.

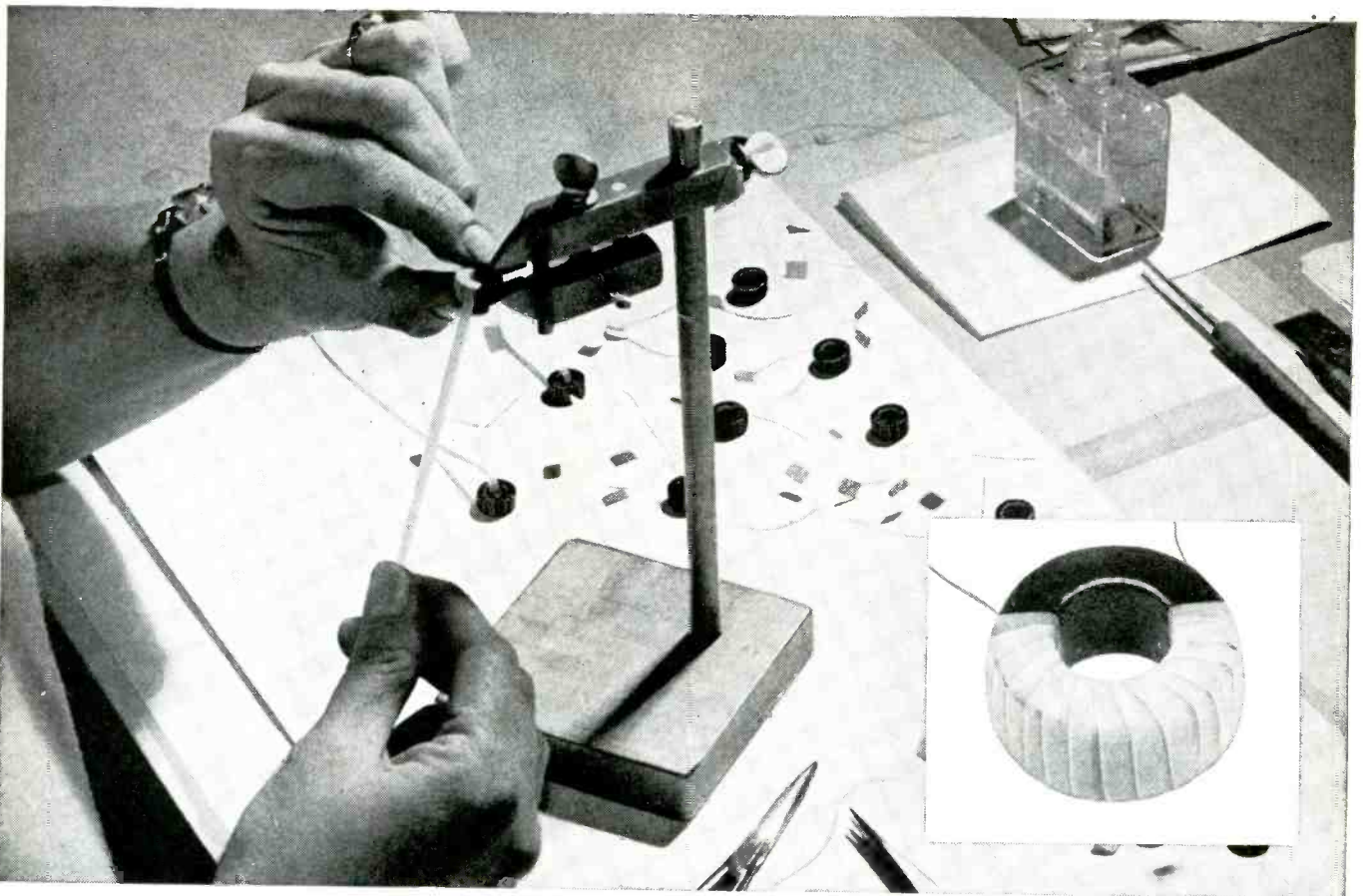

How R/M *Teflon* Tape improves electronic component design

Has high dielectric strength • conforms to intricate shapes

Certain coils in a modern electronic computer required a special kind of insulator. Problem: to design an insulator of the high dielectric strength required—even in thin sections—and conforming to the contours of the small circular coils.

R/M "Teflon" Tape provided the ideal solution to the problem. "Teflon" has unusually high dielectric strength. It is completely unaffected by the many adverse conditions to which electronic components are frequently subjected—corrosive elements (including ozone) in atmospheres, high temperatures, and the like. R/M "Teflon" Tape is relatively easy to apply—even on intricate shapes, such as the ferrite coil shown above.

Here are some of the electrical properties of R/M "Teflon" products:

1. **Power factor** — less than 0.0003 over entire spectrum from 60 cycles to 30,000 megacycles.
2. **Volume resistivity** — greater than 10^{15} ohm-cm, even after prolonged soaking in water.
3. **Surface resistivity** — 3.6×10^{12} ohms, even at 100% humidity.
4. **Good arc-resistance** — on exposure to an arc, the material vaporizes, leaving no carbonized path.
5. **High short-time dielectric strength**— values range from 1000 to 2000 volts per mil, depending upon thickness.
6. **Resists high temperatures** — electrical properties are essentially unchanged up to at least 400°F.

Raybestos-Manhattan has extensive experience in developing R/M "Tef-

lon" products for use in the electrical and electronics industries. Let us fabricate R/M "Teflon" products to your specifications or supply the material in rods, sheets, tubes and tape. Write for your free copy of our bulletin "R/M Teflon Products."

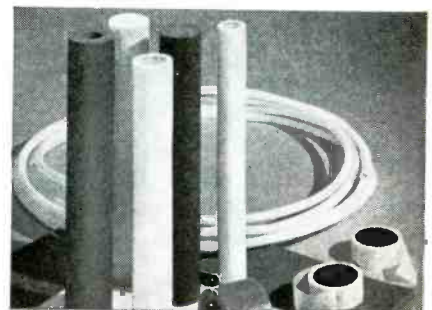

*A Du Pont trademark

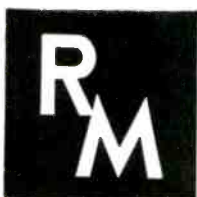

RAYBESTOS-MANHATTAN, INC.

PLASTIC PRODUCTS DIVISION, MANHEIM, PA.

FACTORIES: Manheim, Pa.; Paramount, Calif.; Bridgeport, Conn.; No. Charleston, S.C.; Passaic, N.J.; Neenah, Wis.; Crawfordsville, Ind.; Peterborough, Ontario, Canada

RAYBESTOS-MANHATTAN, INC., Engineered Plastics • Asbestos Textiles • Mechanical Packings • Industrial Rubber • Sintered Metal Products • Rubber Covered Equipment
Abrasive and Diamond Wheels • Brake Linings • Brake Blocks • Clutch Facings • Laundry Pads and Covers • Industrial Adhesives • Bowling Balls

1=4/VOCA model 101

IN ONE INSTRUMENT!

DEMOLAB introduces the VOCA, a precision differential null type potentiometric voltmeter and search VTVM for AC and DC, including a precision calibrator delivering square wave and DC output reference voltages. Plus accessories.

.1V to 500 Volts in a 5 digit readout.
4 Digits .01V to .1V—3 Digits .001V to .01V. 2 Digits .0001V to .001V—Usable readouts down to 50 uv.

to .05% from 0 to 500 Volts DC
to .1% from .5 to 50 Volts RMS AC

1 part in 10,000 at low end of each range.
1 part in 100,000 at high end of each range.

Amplitude referenced against a Standard Cell. Super regulated power supply for stability.

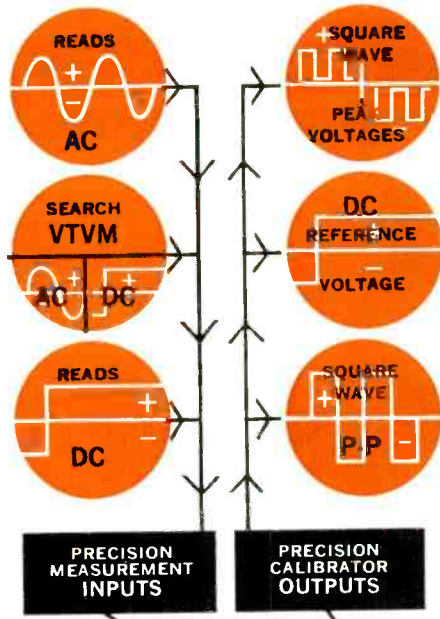

BUILT-IN FEATURES

RANGE—

ACCURACY—

READOUT RESOLUTION—



Rack Mounting with Bench Brackets

ACCESSORY FEATURES:

A family of input probes, shunts, and output units extending the AC range and the basic accurate reference standards of the instrument to an infinite variety of functional uses is available.

DEMOLAB CORPORATION

Instrument Division

1550 North Highland Avenue
Hollywood, California
Representatives in all major areas

ACCESSORIES

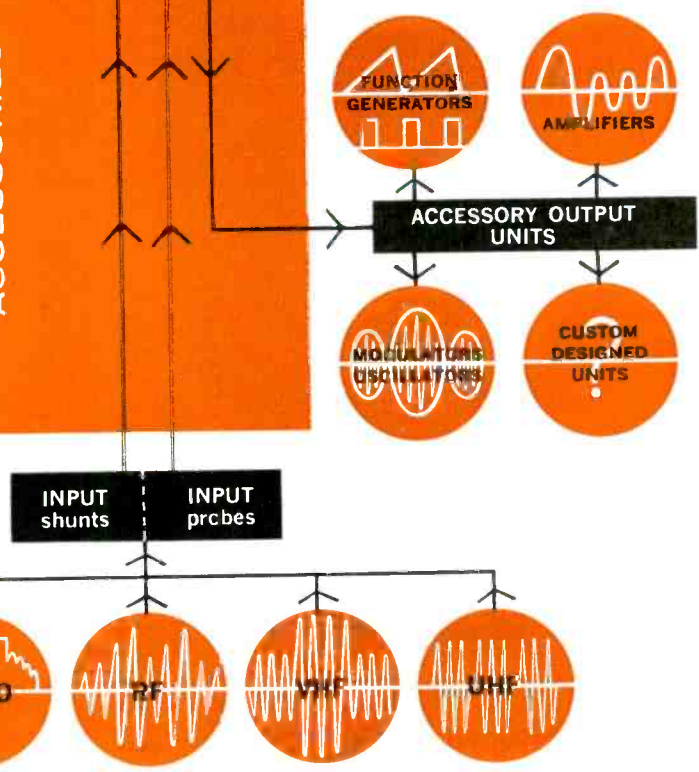

SERVICE DESIGNED WITH YOU IN MIND

TEFLON

All forms including tape, spaghetti, reinforced hose, cementable and copper-clad sheets.

NYLON

Rods, slabs, strip and tube. All formulations.

KEL-F

Sheets, rods, sleeving. Plasticized and unplasticized.

PHENOLIC

All grades, sheets, rods, tubes, including copper clad in stock.

PLEXIGLAS

Clear and Colors, Military and "R" grades.

POLYSTYRENE

Crystal clear sheets to 1" thick. All sizes rods and tubes.

POLYETHYLENE

Rolls (all gauges) Pipe, tubes, rigid and layflat, bags, sheets rods and billets to 36" diameter.

ACETATE

Rods, sheets, rolls.

VINYLITE

Rigid and flexible sheeting, hi-dielectric tubing, layflat and heavy wall pipe.

A warehouse completely stocked with sheets, rods and tubes for all your needs

Custom
Fabrication
Of All
Material

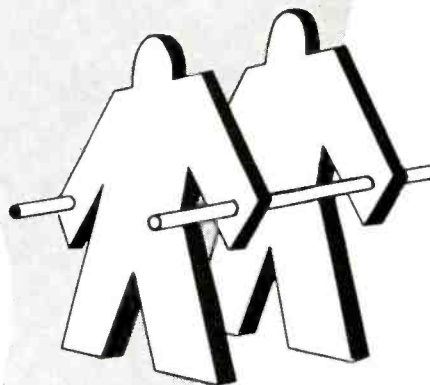

Immediate
Delivery

Ask Allied — They Have It

Write for new Catalog

allied plastics supply corp.

75 cliff street
new york 38, n. y.
beekman 3-7377

613-615 devine ave.
elizabeth, new jersey
elizabeth 4-3856

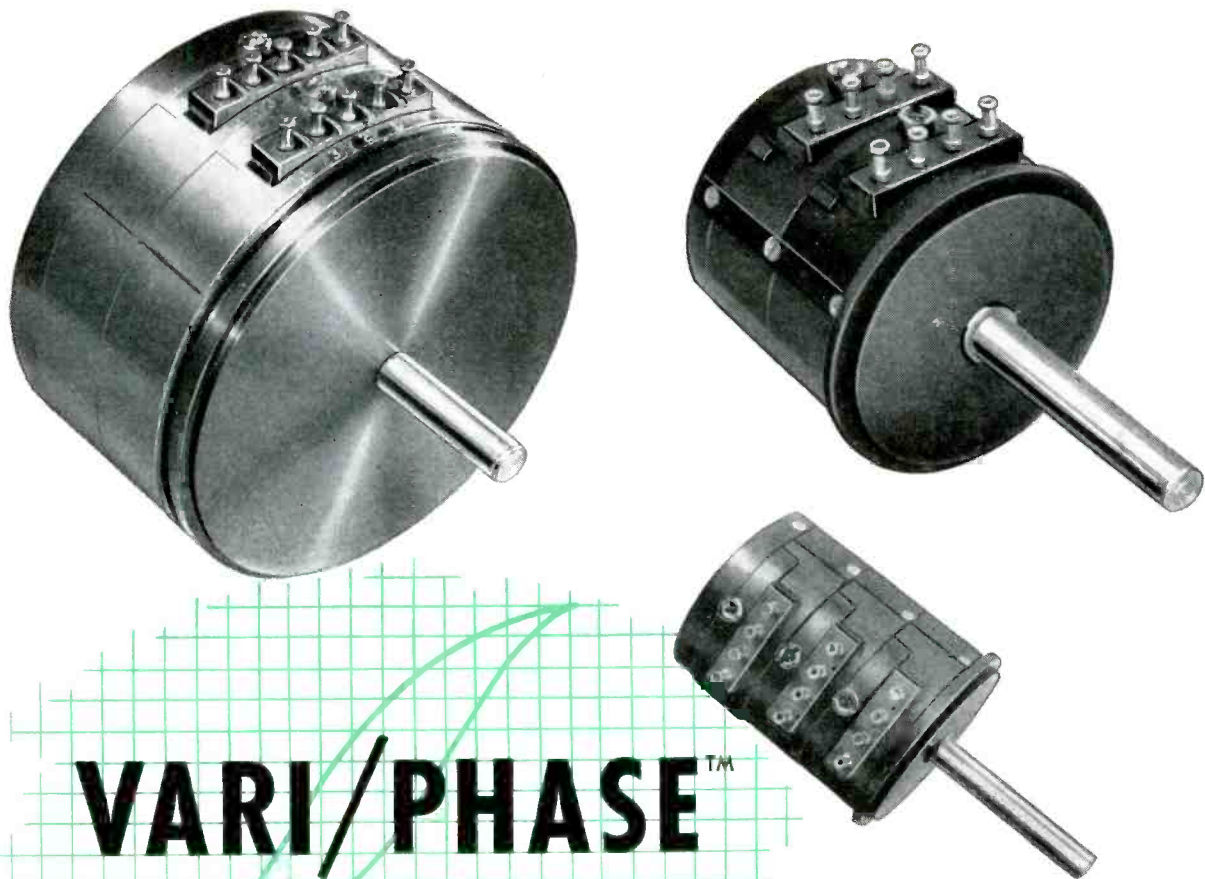

VARI/PHASE™

POTENTIOMETERS

Single-turn, variable-phasing precision potentiometers meeting A.I.A. electrical and mechanical specifications. Five sizes in wide range of resistance values and output functions— $\frac{7}{8}$ "", $1\frac{1}{8}$ "", $1\frac{1}{2}$ "", 2" and 3" diameters. Available as single or gang assemblies. Various mountings and bearings available.

SEND US YOUR REQUIREMENTS!

Independent external phasing, before or after mounting:

Phasing may be done before or after mounting and wiring, permitting readjustment to compensate for circuitry-component tolerance.

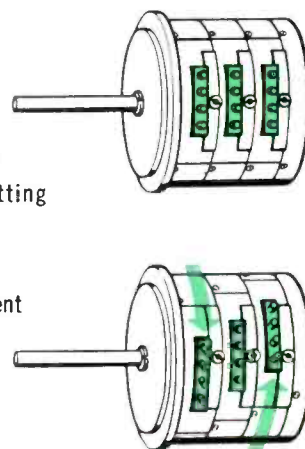

Controls and Resistors

CLAROSTAT MFG. CO., INC. • DOVER, NEW HAMPSHIRE, U. S. A.
In Canada: Canadian Marconi Co., Ltd., Toronto 17, Ont.

**Monitor radiated
signal frequencies
100 times faster!**

with accuracy of ± 1 cps...over
range of 0.54-30.5 megacycles



**Beckman/Berkeley Model 7700
Microsensitive Frequency Measur-
ing System**

Featuring

Exclusive direct digital readout—7-place numerical display for speed, accuracy and convenience.

Broad utility—measures AM, ICW, frequency shift keyed and multiplexed signals.

Extreme sensitivity—detects and measures signals of 1 microvolt strength.

Advanced engineering design—exceeds FCC specifications, is suitable for compliance with Part 15, FCC Rules and Regulations.

Wide range and bandwidth selectivity—30 1-mc frequency bands; bandwidth of 100 cps-6 kc for interference rejection.

Price: \$3500.00 F. O. B. factory

DESIGN AND PERFORMANCE SUPERIORITY

Comprising a unique combination of a quality communications receiver and a high-speed electronic counter, Beckman/Berkeley Model 7700 provides 100,000 times the customary counter sensitivity, and 100 times the frequency measurement speed of other equipment. Its extreme sensitivity and accuracy permit quick, precise measurement of virtually all types of radiated signals in the 0.54 to 30.5 megacycle range, with maximum error of 1 in 10^7 .

Simple and easy to use, the Model 7700 makes possible the measurement and monitoring of broadcast or other frequencies by non-technical personnel with a minimum of training. The system consists of three basic units: a broad range communications receiver, a translator with oscilloscope comparator, and a time-gated electronic counter. An audio system is incorporated for aural monitoring where desired.

Complete technical information on the Beckman/Berkeley Model 7700 Microsensitive Frequency Measuring System is available on request. Write to Dept. G11

Beckman*

Berkeley Division

2200 Wright Avenue, Richmond 3, California

a division of Beckman Instruments, Inc.



HOW TO ADD TO THE Saleability OF MANY ELECTRICAL PRODUCTS

- ... Instruments
- ... Appliances
- ... Small Motors
- ... Radio, TV,
Audio Equipment

TO ENGINEERS, Stackpole Slide Switches in more than a dozen inexpensive types offer many interesting design possibilities for improving product performance.

TO BUYERS of today's instruments and appliances, the convenience of unique and attractive modern switching arrangements exerts strong sales appeal that far exceeds the modest cost involved.

Stackpole Slide Switches cover the 1/2 to 3 ampere range. They vary from simple ON-OFF units to types that provide complicated inter-circuit switching in minimum space—often with less costly mountings than conventional switches. *Electronic Components Division, STACKPOLE CARBON COMPANY, St. Marys, Pa.*

STACKPOLE S - L - I - D - E SWITCHES



New SLIDE SWITCH DATA

Stackpole Bulletin RC-10D — just out — gives complete ratings, dimensions, modifications, and other specifications for all standard Stackpole Slide Switches. Write for your copy or see your local Stackpole representative

KEY TO CONTACT ARRANGEMENTS



POSITION 1

POSITION 2

POSITION 3

POSITION 4

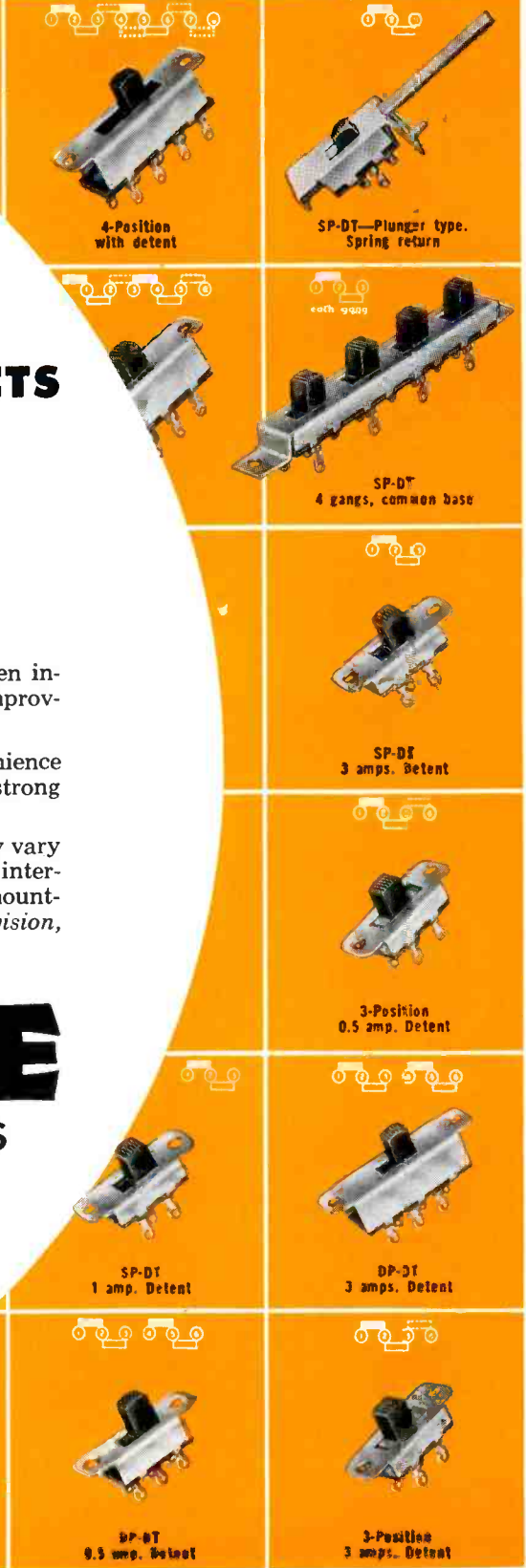

SYSTEMS

1

BASIC "150" assemblies housed in either vertical mobile cabinets or separate portable cases are available in 1-, 2-, 4-, 6- and 8-channel models. Each is equipped with driver amplifiers of current feedback design and regulated power supplies for *each* channel, and a recorder featuring *nine* extremely accurate paper speeds on 2- to 8-channel models, five on single channel units. Appropriate plug-in preamplifiers quickly and efficiently equip a basic assembly for recording virtually any 0-100 cps phenomena.

new 6- and 8-channel analog readout systems

In addition, complete Sanborn systems from 2- to 8-channels are available for recording analog computer outputs. These are equipped with dual-channel DC amplifiers, for single-ended or push-pull signals — input impedance 5 megohms each input lead to ground — drift less than 0.5 mm/hr. — frequency response down 2 db at 60 cycles for all amplitudes to 4 cm peak to peak. Newest of the computer readout recorders are the 6- and 8-channel console systems (8-channel illustrated — "A" at left). The Model 183 Programmer in a Model 184 case ("B" at left) is optional for use with the 6- and 8-channel consoles. The Programmer automatically turns on chart drive, feeds calibrated signals to all channels, reads computer DC levels, determines the length of record, and shuts off the paper drive.

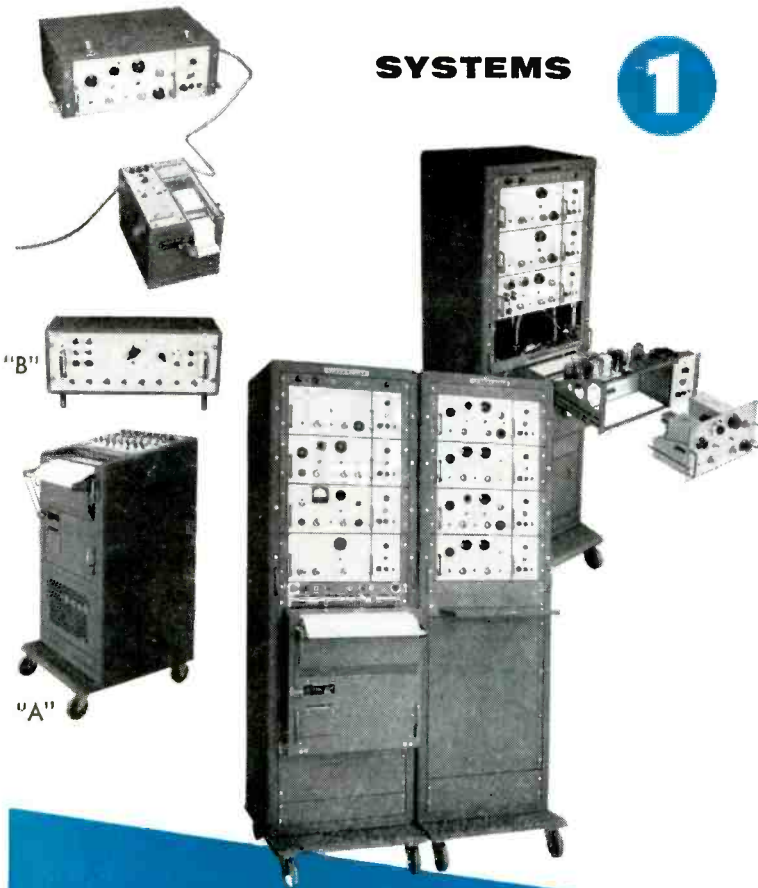

SANBORN

oscillographic recording equipment

3 UNIT INSTRUMENTS

All Sanborn Preamplifiers and Recorders, as well as various other units, are available separately for specialized applications or use as "original equipment" in other apparatus. Instruments include the Model 150-300/700 Wide Band Driver Amplifier and Power Supply, for use with low power galvanometer elements, a 'scope and/or panel meter. When equipped with suitable "150" preamplifier, this amplifier provides a portable indicator for strain, force, pressure, temperature, AC watts, audio level, etc. Other units include the Model 150-1900 Master Oscillator Power Amplifier; Model 150-3100 Triplexer; Model 601 and 602 galvanometers; Model 150-2900 Dual-Channel DC Amplifier.

2

PREAMPLIFIERS

A choice of *twelve* "150 Series" plug-in preamplifiers is now available, to equip systems for any of numerous recording problems. Improved control of input signals results from attenuator ratios of 1, 2, 5, etc., and calibrated zero suppression on AC-DC, Carrier, and Low Level DC Coupling, Frequency Meter, and Chopper Stabilized DC models. Other "150" preamplifiers include: Servo Monitor, Log-Audio, AC Wattmeter, RMS Volt/Ammeter, 400 cycle Frequency Deviation, and Triplexer.

Added to these three aspects of Sanborn Oscillographic Recording Equipment are the basic advantages of inkless recording in true rectangular coordinates, to provide accurate, easily interpreted records; high torque galvanometer (10 ma develops 200,000 dyne cm.); one percent linearity resulting from current feedback driver amplifiers and high torque galvanometers (maximum error is 1/4 mm in middle 4 cm of chart, 1/2 mm across entire chart); controls for timing, manual and remote coding.

Take advantage of the scope and flexibility of Sanborn equipment to answer your recording requirements. Sanborn engineers will be glad to provide further information and application assistance whenever you wish. Contact your local representative or write to the main office below.

SANBORN COMPANY

INDUSTRIAL DIVISION

175 WYMAN ST.

WALTHAM 54, MASS.

TECHNIQUES and DEVELOPMENTS in oscillographic recording

FROM
SANBORN

CIRCUIT DESIGN AND TYPICAL USES OF THE "150" CARRIER PREAMPLIFIER

One of the most frequently used plug-in front ends for Sanborn 150 Series oscillographic recording systems is the Model 150-1100 Carrier Preamplifier, since with it a "150" system can record such variables as force, temperature, strain, pressure, displacement, velocity, flow, acceleration — or any variable which can be expressed as a suitable input signal by a transducer. The "1100 Carrier" will operate with a variety of different transducers and bridge circuits, which will be mentioned later on.



In the block diagram (Fig. 1),

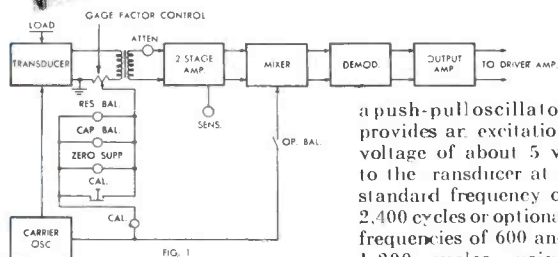

a push-pull oscillator provides an excitation voltage of about 5 v. to the transducer at a standard frequency of 2,400 cycles or optional frequencies of 600 and 1,200 cycles, using plug-in components.

This excitation voltage also feeds the Balancing, Calibration and Zero Suppression circuits. (The Balancing controls allow correction of resistive and reactive signal leakage from the

transducer, so that at zero load the net signal to the Pre-amplifier is zero. The Zero Suppression feature permits bucking out a large static load so that a small part of the load can be expanded over the full recording chart. The Gage Factor control allows the zero suppression range to be made equivalent to some convenient transducer load, or the full load rating of the transducer, and also causes the calibration signal to represent 2% of that load.) Transducer output is fed to the transformer through the Gage Factor potentiometer, across which the Balancing-Calibration-Zero Suppression circuits develop a voltage effectively in series with the transducer output. The mixer receives a suppressed carrier AM signal and re-inserts a carrier component, to make its output a conventional AM signal whose modulation represents the transducer load. The modulation signal (whose amplitude and polarity represent magnitude and direction of transducer output) is recovered by the demodulator and fed to the output amplifier, which in turn excites the Driver Amplifier and recording galvanometer of a "150" system.

Transducers which may be used with the Carrier Preamplifier include strain gage half-bridges or full-bridges, commercial resistance or reactance bridges, differential transformers and resistance thermometer bridges. The transducer chosen should provide at least 18.0 microvolts per volt of excitation at the minimum load to be recorded, for a one cm. deflection; impedance should be 100 to 1000 ohms. With strain gages, normal operation provides sensitivities of 50, 20 or 10 micro-inches per inch for each cm. on the recording, depending on the number of active gages. With resistance thermometers, if 1°C. or 2°F. per cm. stylus deflection is sufficient sensitivity, the user can construct his own resistance thermometer by including a 3 ohm coil of copper wire in one arm of an equal arm 100 ohm bridge.

Helpful information about the use of transducers with the 150-1100 Preamplifier is contained in the following Sanborn RIGHT ANGLE articles (reprints on request): Coupling Differential Transformers, Aug. and Nov. 1956; Filter Networks for use with Force Dynamometers, Nov. 1956; Calibration with 1-, 2- or 4-arm Strain Gage Bridges, Aug. 1955; Theoretical and Actual Applications of Bridge Circuits, May and Aug. 1954.

Wing flutter recording to infrared research . . . with the versatile "1100 Carrier"



Today, Carrier Preamp-equipped Sanborn "150" systems are being used for frequency response tests of process control system components; to record shaft deflections of fluid mixing equipment; in infrared research . . . vehicular traffic studies . . . submarine hull vibration measurements. Applications are limited only by the transducers available.

These are applications of only one "150" front-end; eleven more interchangeable, plug-in Preamplifiers increase the scope of Sanborn oscillographic recording systems to meet an almost infinite variety of research, production and field testing requirements. All Sanborn "150" direct writing systems record inkless traces in true rectangular coordinates; all provide 1% linearity; Basic Assemblies — equipped with your choice of Preamps — are available from one- to eight-channels, packaged in vertical cabinets, portable cases, or specially modified housings.

Technical data and help with your oscillographic recording problem are always available from Sanborn.



SANBORN COMPANY
INDUSTRIAL DIVISION
175 Wyman St., Waltham 54, Mass.

SPECIFICATIONS

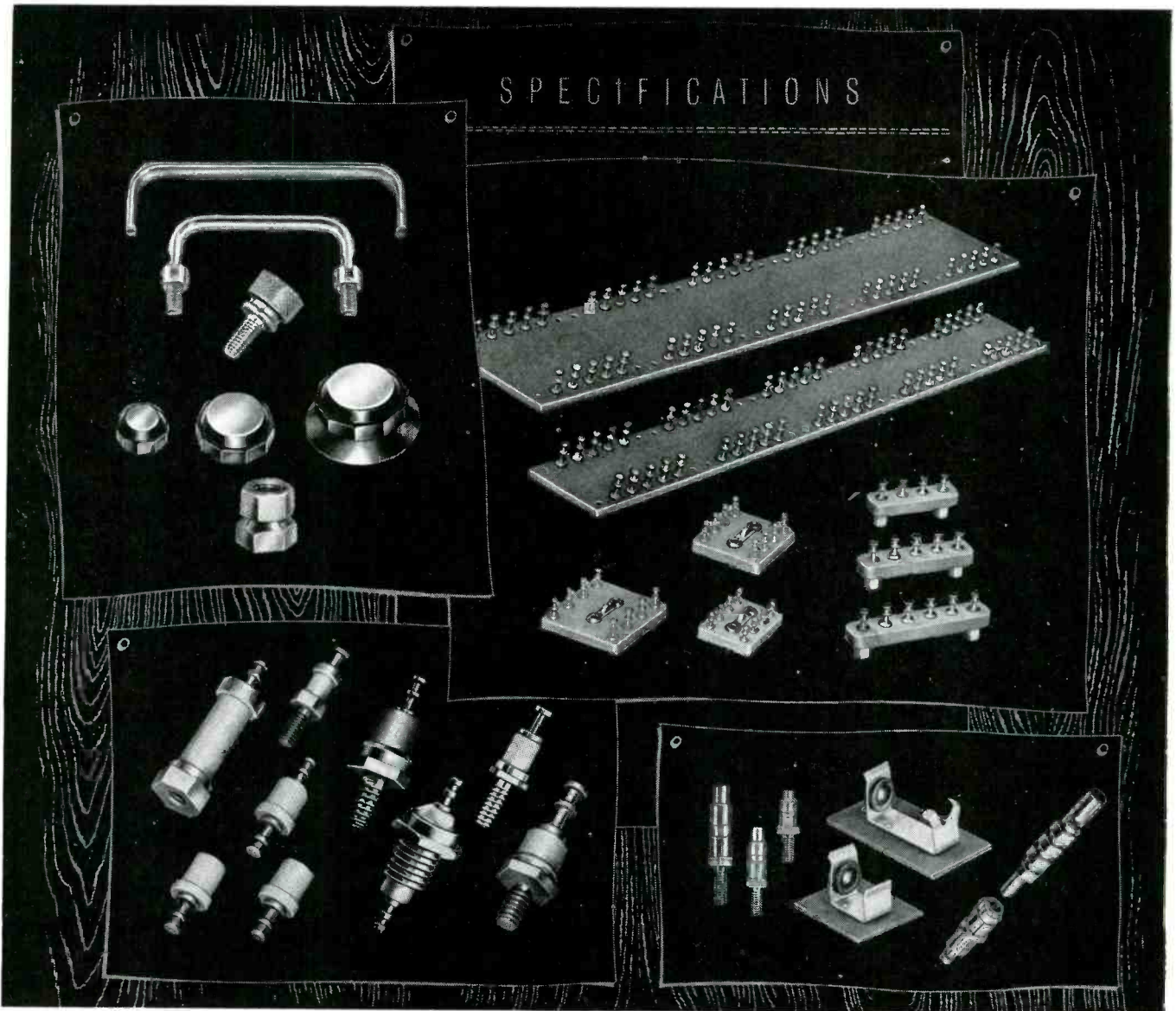

Photo shows wide variety of CTC components. Upper left, hardware, knobs, panel screws. Upper right, standard terminal boards, phenolic and ceramic. Bottom row, insulated terminals in ceramic and teflon, diode clips, battery clips, plugs and jacks. Common denominator — CTC reliability.

If specifications call for durability specify CTC hardware

Durability is not just a term at CTC — it's practically a manufacturing process! Take the above line of CTC hardware for example. CTC guarantees it and every one of its components unconditionally — in any quantity! That's high quality control — quality control that meets or betters all applicable military and government specifications. CTC quality controls the raw material, each step of production and the finished product — the result — *exceptional durability*.

Best of all you get this durability economically. In fact — you couldn't make such hardware items

cheaper yourself! Our large selection of standard panel and chassis hardware fills most needs. If you require custom design, contact us direct.

Send for CTC's Catalog 600 — it has all the details of CTC's complete hardware line. Write to Sales Engi-

neering Dept., Cambridge Thermionic Corporation, 437 Concord Ave., Cambridge 38, Mass. On the West Coast contact E. V. Roberts and Associates, Inc., 5068 West Washington Blvd., Los Angeles 16, and 1560 Laurel St., San Carlos, Calif.

CTC

CAMBRIDGE THERMIONIC CORPORATION

*makers of guaranteed electronic components
custom or standard*



Concerned with microwave test equipment?

Only NARDA offers you these

exclusive features!

TURRET ATTENUATORS

Only Narda offers you a UHF-only attenuator. This represents a considerable savings in cost for applications in this frequency range. Each of three models offers the Designer or Development Engineer 12 steps of attenuation from d.c. to 1,500 mc with a VSWR of 1.25. Designed for bench use or mounting into test equipment packages.

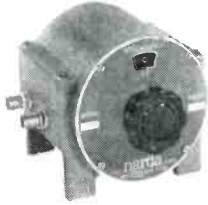

One unit can give a maximum of 30 db attenuation; two units can be used in series to provide a wide range of control in small steps.

- Model 705—0, 3, 6, 9, 12, 15, 20, 25, 30 db
- Model 706—0, 1, 2, 3, 4, 5, 6, 7, 8, 9, 10, 20 db
- Model 707—0, 3, 6, 9, 12, 15, 18, 21 INF db

ALL MODELS ... \$275 each

COAXIAL DIRECTIONAL COUPLERS



10, 20 and 30 DB ... 225 to 4,000 mc.

Only Narda offers coaxial directional couplers in 10 and 30 db values, as well as 20 db. In addition, all models offer such advantages as these:

1. Flat Coupling—values with 1 db of nominal over a full octave frequency range, with calibration provided to ± 0.2 db accuracy.
2. Machined from solid blocks of aluminum—hence, more rugged.
3. Directivity exceeding 20 db.
4. Frequency Ranges: 225-460, 460-950, 950-2000, 2000-4000 mc.

Write for complete specifications.

\$100 to \$225

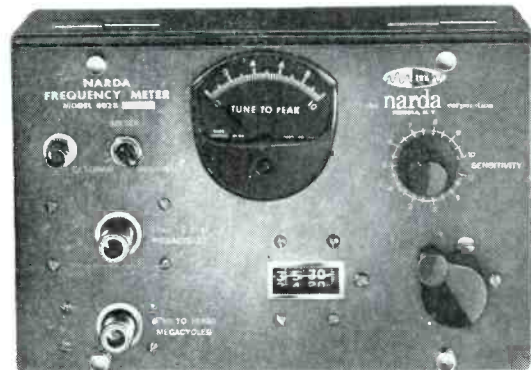

S to X BAND FREQUENCY METER

Narda offers the only single instrument covering this complete band of frequencies—2,350 to 10,500 mc. In addition, no combination of other meters can cover these frequencies at a comparable price!

An easy to read nomograph type calibration chart, mounted in the lid, converts digital counter readings to frequency in megacycles—to the rated accuracy of 0.2%. No calculations or interpolations are needed.

The unit is completely self contained, with built-in detector and indicating meter. A sensitivity control allows use with strong signals; for signals below 5 mw., the external meter jack may be connected to an amplifier or oscilloscope.

Model 802B ... \$785

UHF FREQUENCY METER DETECTORS ... Direct Reading

The only direct reading frequency meter detectors available for the UHF range—and they're from Narda, of course! Absorption type meters, with 0.2 db insertion loss, each includes a resonant cavity, coaxial switch, crystal detector, current meter, sensitivity control and type N terminals.



SPECIFICATIONS

Frequency (mc)	Accuracy	Loaded Q	VSWR	Sensitivity for full scale deflection	NARDA Model	Price
200-500	0.5 mc	500	1.15	0.2 mw	804	\$375
500-1500	1 mc	700	1.15	0.2 mw	805	375
1500-2400	2 mc	500	1.25	0.5 mw	806	375

Complete Coaxial and Waveguide Instrumentation for Microwaves and UHF — including:

- | | | |
|----------------------|---------------|----------------------|
| DIRECTIONAL COUPLERS | TUNERS | ATTENUATORS |
| TERMINATIONS | ECHO BOXES | STANDARD REFLECTIONS |
| FREQUENCY METERS | SLOTTED LINES | BOLOMETERS |
| HORNS | BENDS | THERMISTORS |

MAIL COUPON TODAY FOR
FREE CATALOG AND NAME OF
NEAREST REPRESENTATIVE

The Narda Microwave Corporation
160 Herricks Road
Mineola, N. Y.
Dept. E-2.



NAME _____
COMPANY _____
ADDRESS _____
CITY _____ ZONE _____ STATE _____



the narda

microwave corporation

160 HERRICKS ROAD, MINEOLA, N. Y. • PIONEER 6-4650

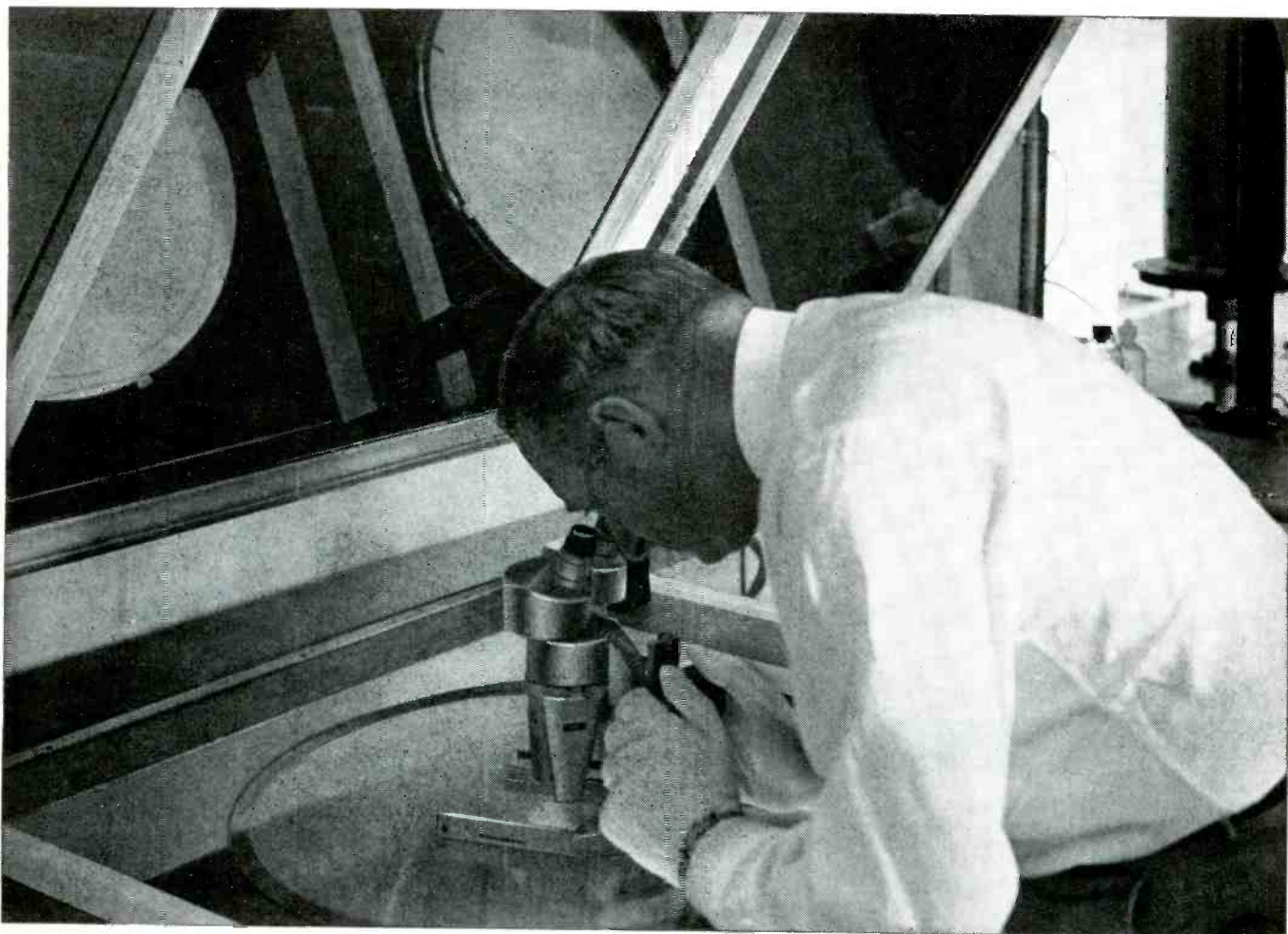

Get Sharper, Truer Color TV Pictures

New tapered-hole aperture mask reduces beam diffusion . . . minimizes false color . . . can be used in present design picture tubes

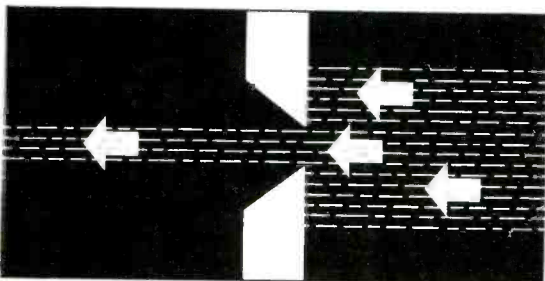

NEW tapered-hole aperture mask. See how electron beam passes through hole without diffusion. Hole dimensions: .010 in. small diameter, .015 in. large diameter. There are nearly 500,000 of these holes in each mask—all controlled to close tolerance.

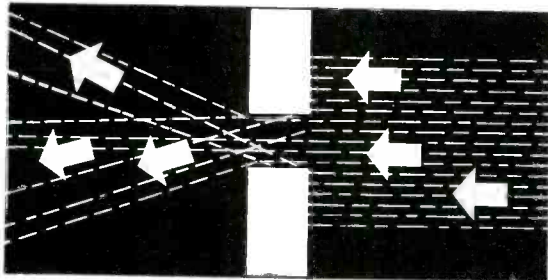

OLD cylindrical hole aperture mask. Electrons striking aperture walls are scattered over several dots.

Here's another long step forward toward better color television—one that doesn't require radical changes in circuitry or picture tube construction. It's an improved aperture mask made by Superior Tube* that can be used in the picture tubes you are now using.

Ideally, an aperture mask should have zero thickness. Because electrons impinging on the walls of cylindrical holes are deflected out of the narrow beam and sometimes strike adjacent color dots instead of the single dot they are directed at. The result is a hazy picture or false color. But with these new Superior Tube tapered-hole aperture masks, beam diffusion is practically eliminated. The walls of the tapered holes lie outside the path of beam electrons—even at the extreme edges of the picture. The electrons see only the holes.

These new aperture masks demonstrate how accurate and to what close tolerances Superior Tube can fabricate metal components. For complete information, write for Data Memo No. 5. Superior Tube Company, 2500 Germantown Ave., Norristown, Pa.

**Manufactured by Superior Tube Co. under license from Buckbee Mears, Co., St. Paul, Minn. Other parts Superior Tube makes for use in color TV receivers include three different types of disc cathodes (miniature, narrow neck and standard), seamless anodes, and a complete line of sleeve-type cathodes. Superior Tube is the world's largest independent supplier of cathodes for use in electron tubes.*

Superior Tube

The big name in small tubing
NORRISTOWN, PA.

Johnson & Hoffman Mfg. Corp., Mineola, N.Y.—an affiliated company making precision metal stampings and deep-drawn parts such as those used in the electron guns that go with this new cathode.

SRU-55 Series Klystrons give high power at low voltage

Small reflex oscillator klystrons for 14.5-17.0 kmc and 15.7-17.0 kmc

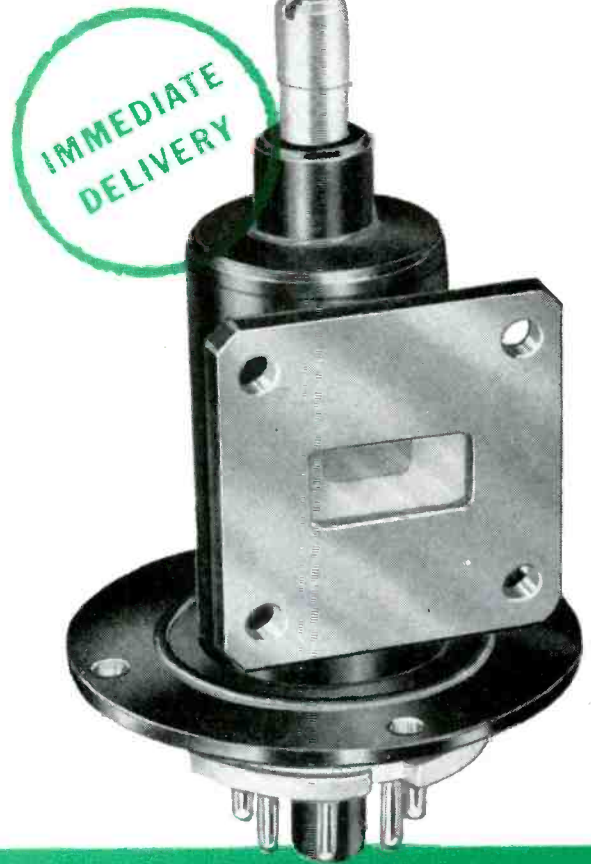

SRU-55 OPERATING SPECIFICATIONS

14.5 to 17.0 kmc
300 v
45 to 75 mw
20 mw

SRU-55A OPERATING SPECIFICATIONS

Frequency	15.7 to 17.0 kmc
Beam Voltage	300 v
Output Power (optimum load)	40 to 45 mw
Minimum Output Power	20 mw

Ready for immediate delivery are two Sperry K Band Klystrons. The SRU-55 and SRU-55A satisfy a multiplicity of requirements yet are manufactured with the economies of a single tube type.

The SRU-55 was developed primarily as a local oscillator in radar systems.

Only 3 $\frac{1}{32}$ " high and 1 $\frac{1}{16}$ " in diameter, it couples rugged construction with superior vibration characteristics to withstand the severe environment of airborne applications for thousands of hours. The SRU-55 exhibits high

frequency stability under abrupt changes in line voltage. Objectionable leakage has been controlled to eliminate need for external shielding. Other features include low voltage operation and ease of tuning over an extremely broad range with no appreciable hysteresis.

The SRU-55A was designed especially as a signal source for test sets like the AN/UPM-28-29. Other applications: local oscillator in microwave receivers and spectrum analyzers; low-power transmitting tube. Important features

include minimum leakage and excellent test modes. Dimensions and operating features are similar to those of SRU-55. Write or phone your nearest Sperry district office for more details.

ELECTRONIC TUBE DIVISION
SPERRY GYROSCOPE COMPANY
Great Neck, New York

DIVISION OF SPERRY RAND CORPORATION

BROOKLYN • CLEVELAND • NEW ORLEANS • LOS ANGELES •
SAN FRANCISCO • SEATTLE. IN CANADA: SPERRY GYROSCOPE
COMPANY OF CANADA, LTD., MONTREAL, QUEBEC



Why Corning High-Power, High-Frequency Resistors meet your most exacting circuit requirements

You'll find Corning High-Power and High-Frequency Resistors designed for stable, long-life service—even under the most difficult operating conditions.

With Corning Resistors you get the highest resistance range for a given physical size compared to wire-wound resistors.

Their thin-film construction makes them inherently non-inductive. The noise level of these resistors is so low it's difficult to measure. The resistive film is a metallic oxide, fused to the PYREX® glass core at red heat to form a permanent bond. This special glass insures highest core resistivity even at elevated temperatures, great resistance to chemical attack and to mechanical and thermal shock.

These Corning Resistors are remarkably stable regardless of mois-

ture and humidity.

They meet all characteristics of MIL-R11804B.

The chart in the next column gives you a quick idea of their exceptional frequency characteristics.

The ranges and ratings shown in the illustration are for our standard lines, but we can design and build resistors to match your own requirements for all usable frequencies. We have made specials with ratings up to 150 kw. and we can go higher.

Within the standard range of these resistors, we can give you wide variations in mounting hardware. You can get hardware for vertical or horizontal mountings and mountings to absorb mechanical shock and severe vibration. Ferrule-type terminals are available for use with standard fuse clips.

For more complete details, write for catalog sheets.

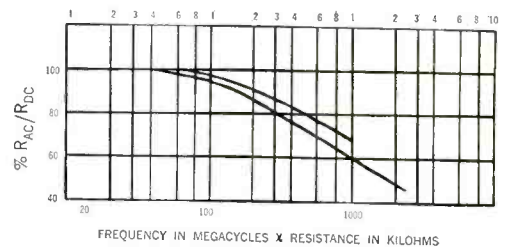

Keep your file up-to-date with data on these other electronic components made by Corning in addition to the Types R*, H, and HP Resistors: Low Power, Types N, S*, and WC-5; Capacitors: Fixed Glass*, Transmitting, Canned High-Capacitance, Subminiature Tab-Lead, Special Combination. Direct Traverse* and Midget-Rotary* Trimmers. Metallized: Glass Inductances; Attenuator Plates; Fotoform Glass; Electrolytic Level Switches.

*Distributed by Eric Resistor Corporation

Corning means research in Glass



CORNING GLASS WORKS, 94-11 Crystal Street, Corning, N. Y.
Electronic Components Sales Department

Waldes Truarc Retaining Ring eliminates 7 parts, saves \$8.88 in sub-assembly of aerial reconnaissance camera

Gordon Enterprises, No. Hollywood, California, saved the Navy almost 1 1/2 million dollars on 500 cameras. Gordon rebuilt new, efficient "CA" series out of Navy-owned obsolete models. Critical parts are now held together by Waldes Truarc Retaining Rings.

Truarc Rings are trouble-free, will not change position during operation. Accuracy is limited only by groove and ring dimension tolerances. And standardized Truarc Rings are quickly interchangeable in overhaul which now takes only 11 minutes, can be handled by unskilled technicians.

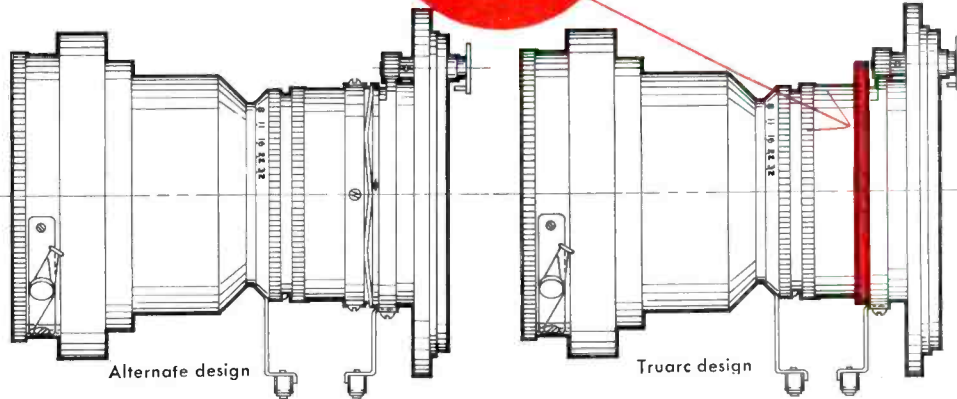
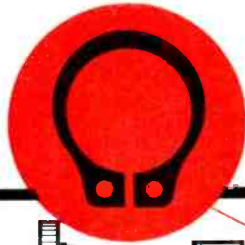
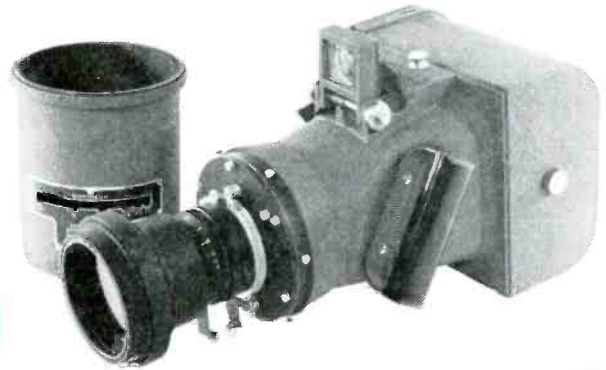

Truarc 5100-287 ring retains shutter speed adjustment mechanism on the Lens Adapter Plate Assembly which mounts and locks the lens

and shutter assemblies accurately to camera body. Alternate design required retaining washer, spring, collar and 4 locking screws.

Weight Saving: 7.25 oz.

Assembly Time Saving: 6 1/2 min.

DOLLAR SAVINGS:

Material \$.93

Fabrication 6.88

Inspection 1.07

Total \$8.88

Whatever you make, there's a Waldes Truarc Ring designed to save you material, machining and labor costs, and to improve the functioning of your product.

In Truarc, you get

Complete Selection: 36 functionally different types. As many as 97 standard sizes within a ring type. 5 metal specifications and 14 different finishes. All types available quickly from leading OEM distributors in 90 stocking points throughout the U.S. and Canada.

Controlled Quality from engineering and raw materials through to the finished product.

Every step in manufacture watched and checked in Waldes' own modern plant.

Field Engineering Service: More than 30 engineering-minded factory representatives and 700 field men are at your call.

Design and Engineering Service not only helps you select the proper type of ring for your purpose, but also helps you use it most efficiently. Send us your blueprints today...let our Truarc engineers help you solve design, assembly and production problems...without obligation.

For precision internal grooving and undercutting . . . Waldes Truarc Grooving Tool!

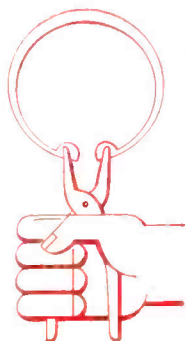

WALDES
TRUARC[®]
RETAINING RINGS
WALDES KOHINOOR, INC.
47-16 AUSTEL PLACE, L. I. C. 1, N. Y.

New Catalog →

Waldes Kohinoor, Inc., 47-16 Austel Place, L. I. C. 1, N. Y.
Please send new, descriptive catalog showing all types of Truarc rings and representative case history applications. (Please print)

Name

Title

Company

Business Address

City Zone State

E119

WALDES TRUARC Retaining Rings, Grooving Tools, Pliers, Applicators and Dispensers are protected by one or more of the following U.S. Patents: 2,382,948; 2,411,426; 2,411,761; 2,416,852; 2,420,921; 2,428,341; 2,439,785; 2,441,846; 2,455,165; 2,483,379; 2,483,380; 2,483,383; 2,487,802; 2,487,803; 2,491,306; 2,491,310; 2,509,081; 2,544,631; 2,546,616; 2,547,263; 2,558,704; 2,574,034; 2,577,319; 2,595,787, and other U.S. Patents pending. Equal patent protection established in foreign countries.

glass-base laminates?

C-D-F DILECTO® is the answer!

Teflon*, silicone, epoxy, melamine, and phenolic glass-fabric laminates. Polyester glass-mat laminates.

You can improve design, speed production, and save money by specifying one of the many C-D-F Dilecto grades. Whatever your application for these laminates — with fine- or medium-weave glass-cloth base — you'll find a better answer to your problem at C-D-F. (Melamine can also be made with glass-mat base.) And C-D-F offers modern machining and fabrication facilities to deliver production quantities of finished Dilecto parts to your specifications.

See our catalog in Sweet's Product Design File, where the phone number of your nearby C-D-F sales engineer is listed. For free trial samples of glass-base Dilecto, or of any other C-D-F plastics, mica, or fibre product, send us your print or your problem! Write for your free copy of C-D-F Technical Bulletin 64.

*DUPONT TRADEMARK FOR TETRAFLUOROETHYLENE RESIN

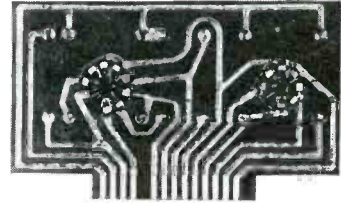

SPEED AUTOMATIC PRODUCTION of printed circuits with warp-resistant C-D-F metal-clad Teflon* and epoxy laminates. Other advantages: high bond strength of copper to laminate, superior blister-resistance in solder immersion.

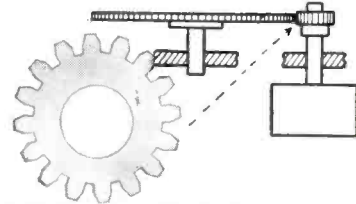

HIGH-VOLTAGE (1800v.) RF ISOLATION is achieved by miniature C-D-F Dilecto gears in an aircraft receiver-transmitter switch. They also had to exhibit dimensional stability through a wide temperature range, resistance to fungus growth and thermal shock.

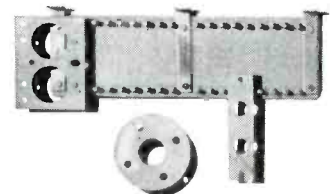

PRECISE MACHINING AND FABRICATION are standard benefits of Dilecto laminated plastics. These silicone glass-base parts (coil mountings, aircraft terminal board) were sawed, drilled, punched, and milled in production quantities by C-D-F and customer.

PROPERTIES OF SOME TYPICAL C-D-F DILECTO GLASS-BASE GRADES

Grade	Equivalent NEMA or ASTM grade	Flexural Strength Lengthwise (PSI)	Dissipation Factor at 10 ⁶ Hz Cond. A	Dielectric Strength Parallel Step x step	Insulation Resistance Cond. C96/35/90	Arc Resistance (seconds)	Maximum Operating Temp. (°C.)
GB-112T (Teflon*)	None	14,000	0.0015	65	100,000	180 +	250
GB-12S (Silicone)	G-7	28,000	0.002	60	100,000	180 +	200
GB-28E (Epoxy)	G-10	70,000	0.019	65	75,000	130	150
GB-28EFR (Flame-Retardant Epoxy)	G-10	68,000	0.010	65	100,000	180	150
GB-28M (Melamine)	G-5	50,000	0.014	50	100	185	135
GB-261D (Phenolic)	G-1 and G-2	22,000	0.020	55	10,000	5	150
GM-PE (Polyester)	GPO-1	35,000	0.020	70	200	130	150

These are typical grades for typical applications. To meet special requirements, C-D-F makes many other Dilecto grades, one of which may serve your purpose better than any of these listed here. Consult the C-D-F Technical Department for expert assistance with your design problem involving laminated plastics products.



CONTINENTAL-DIAMOND FIBRE

A SUBSIDIARY OF THE *Burns* COMPANY • NEWARK 16, DELAWARE

thousands of combinations for

REMOTE CONTROL SWITCHING



OAK
rotary
SOLENOIDS*

*Mfd. under license from
G. H. BLAND, INC.

OAK
low-current
SWITCHES

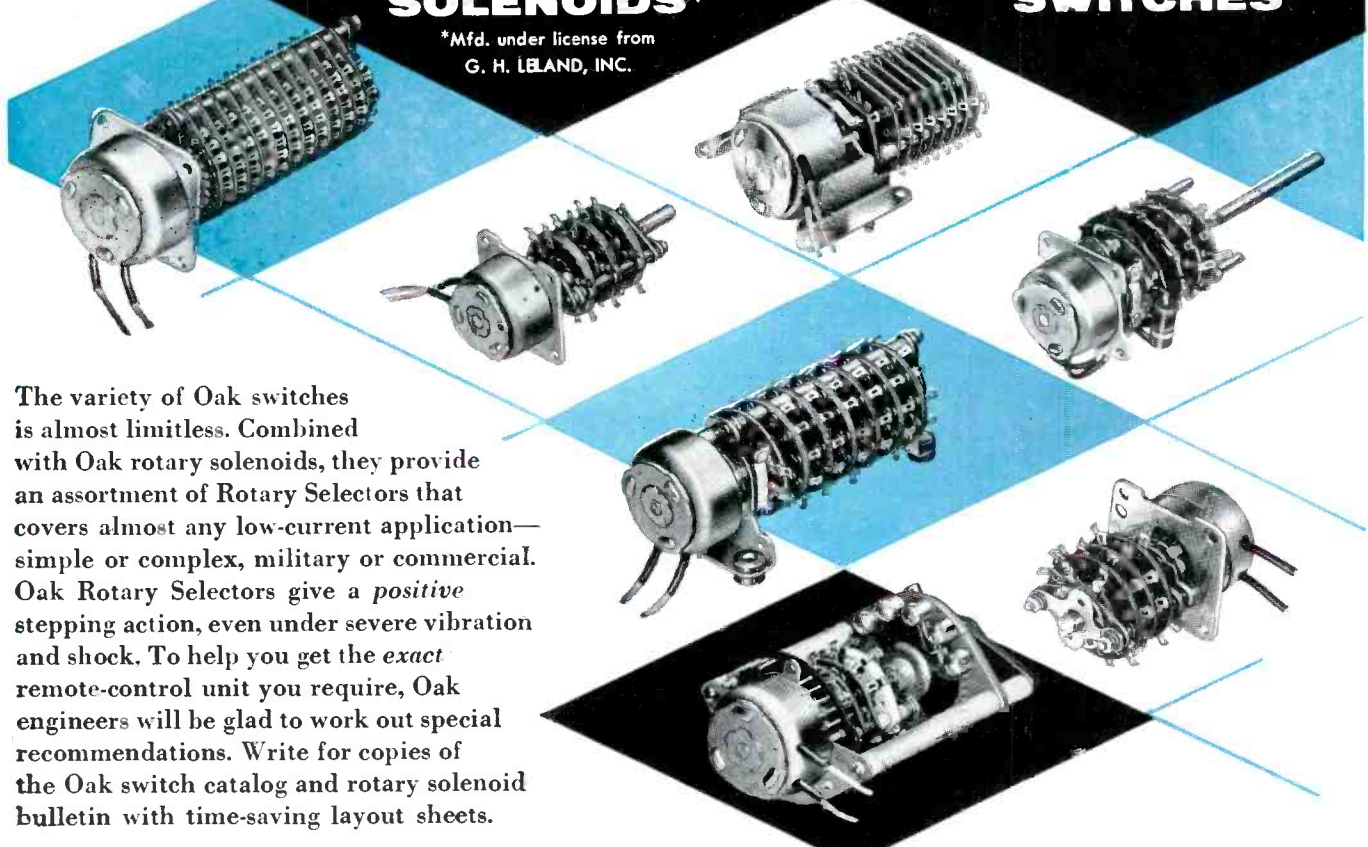

The variety of Oak switches is almost limitless. Combined with Oak rotary solenoids, they provide an assortment of Rotary Selectors that covers almost any low-current application—simple or complex, military or commercial. Oak Rotary Selectors give a *positive* stepping action, even under severe vibration and shock. To help you get the *exact* remote-control unit you require, Oak engineers will be glad to work out special recommendations. Write for copies of the Oak switch catalog and rotary solenoid bulletin with time-saving layout sheets.

SWITCHES • ROTARY SOLENOIDS •
CHOPPERS • SPECIAL ASSEMBLIES •
VIBRATORS • TUNERS

OAK MFG. CO. 

1260 Clybourn Avenue, Dept. G, Chicago 10, Illinois
Phone: MOhawk 4-2222

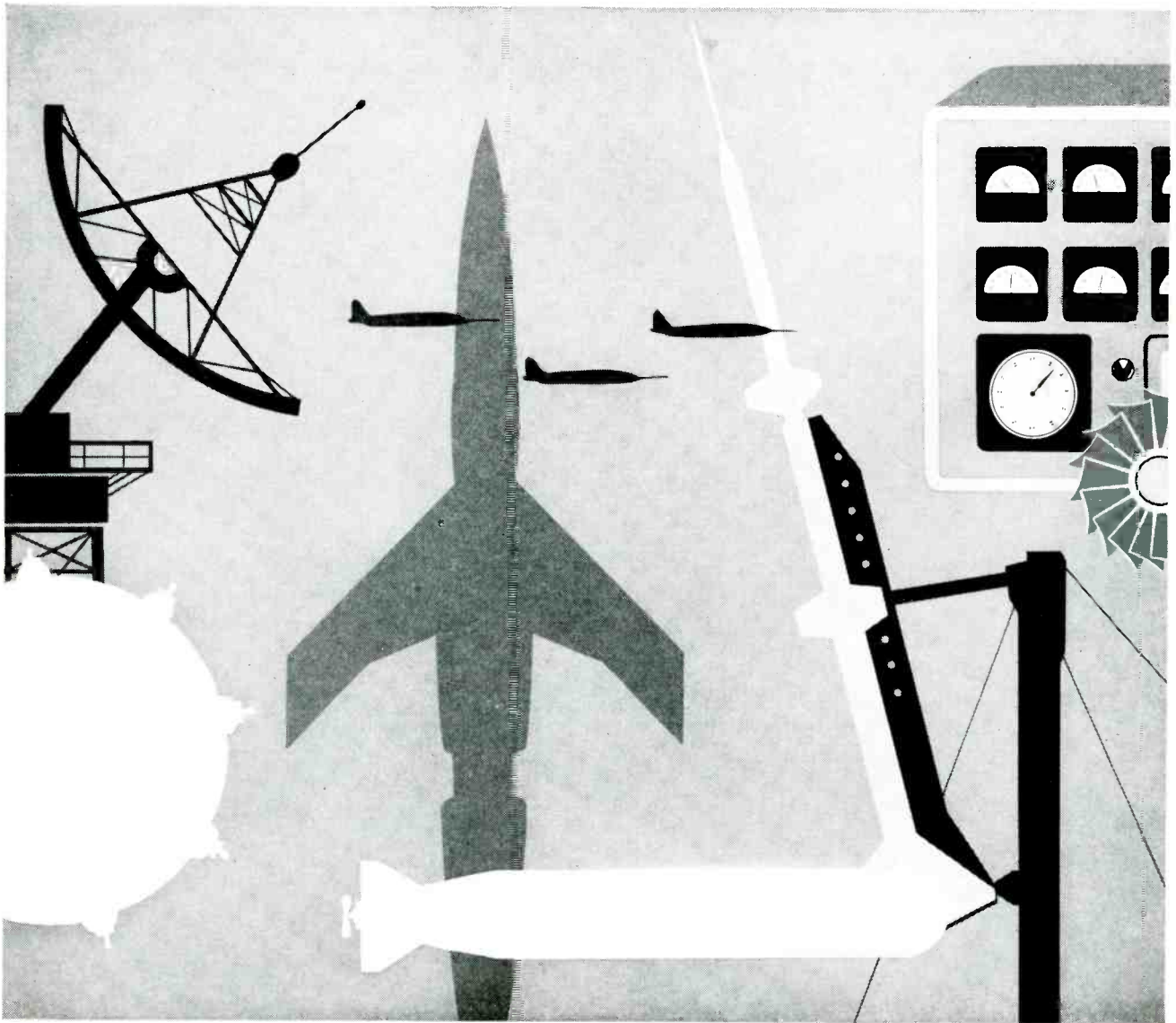

Throughout the Pattern of Modern Defense...

AMF has experience you can use

• Most defense problems fit into AMF's "big picture"... a picture drawn from AMF's tremendous backlog of experience in defense work. Wherever you are, there's probably an AMF defense component or integrated system... a product of AMF experience... operating near you. • Guided missiles ride on AMF equipment to AMF launching sites... to be loaded, fueled and fired by AMF-built equipment. Under the sea, AMF-built weapons wait for unfriendly submarines on the prowl. Along our borders, AMF radarscopes search the sky for "stranger" aircraft. • There is little room for failure where the job is the nation's defense. And the nation looks to companies like AMF to design, test and produce a variety of defense products. With a wide range of experience in the most sensitive fields of defense work, AMF may well be the answer to your problems... in defense or industry.

- Armament
- Ballistics
- Radar Antennas
- Guided Missile Support Equipment
- Auxiliary Power Supplies
- Control Systems



Defense Products Group

AMERICAN MACHINE & FOUNDRY COMPANY

1101 North Royal Street, Alexandria, Va.

Asbury Park • Atlanta • Boston • Brooklyn • Dallas • Dayton • Los Angeles • Seattle • Tucson • Washington, D. C.

ESC corporation, first in custom-built delay lines,

announces the opening of its new...

electronic components division

ESC®

pulse transformers

medium and low-power transformers

filters of all types

pulse-forming networks

miniature plug-in encapsulated circuit assemblies

*exceptional employment opportunities
for engineers experienced in pulse techniques*



ESC

CORPORATION • 534 BERGEN BOULEVARD • PALISADES PARK, NEW JERSEY

Who's Minding The Store?

... in the magazine publishing business, it's

The Audit Bureau of Circulations (ABC) is a cooperative organization that sets standards of good business conduct for its publisher members. Twice each year ABC auditors carefully scrutinize the entire circulation structure and operation of every member magazine. In a very real sense, therefore, they are "minding the store" — making sure that no false or misleading claims are made regarding the size or composition of a magazine's audience.

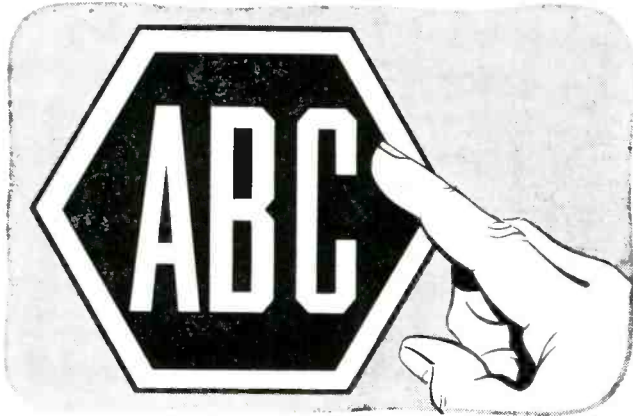

McGraw-Hill is a charter member of ABC and has supported its aims continuously for over 40 years. We believe this membership serves you by providing full assurance that every subscriber to McGraw-Hill magazines displaying the ABC symbol is paying to receive his copies.



Accurate Figures — about you are the heart of ABC's job. ABC does a candid, unbiased, certified audit of all subscription figures of member magazines — and of the subscribers' jobs, functions, and locations. These audits help editors to tailor the contents of their magazine to your specific job interests.



You're the boss when you pay money for any magazine. Your vote of confidence and your renewals of subscriptions are dominant in the thinking of editors and publishers. Advertisers are vitally interested, too, and their support helps earn the dollars needed to do a stronger, more useful editorial job for you.



You, the subscriber, win when you buy business magazines that hold membership in the Audit Bureau of Circulations. The ABC symbol signifies that the publication to which you subscribe makes every effort to provide you with the type of information you need to do a better, more effective job. It also indicates that the publisher maintains the highest standards of business ethics.

McGraw-Hill Publications

McGraw-Hill Publishing Company, Inc.

330 West 42nd Street, New York 36, N. Y.

ONE INTEGRATED SOURCE

for Ceramic-to-Metal Seals



Standard types of Alite high voltage bushings are available in various sizes and configurations.

INSIDE LOOK AT ALITE—



Fact-packed, illustrated Bulletins A-20 and A-7R just off the press. Give vital technical data and product information. Write today.

In *all* phases of planning for ceramic-to-metal seals—from design to finished assembly—you can rely on ALITE for the know-how and “do-how” required to produce highest quality ceramic-metal components for critical applications.

High alumina Alite is the ideal material for making rugged, high performance hermetic seals and bushings. It has superior mechanical strength, high temperature and thermal shock resistance, plus reliable electrical characteristics. Our complete high temperature metalizing and bonding facilities assure delivery of the finest seals available—mass-spectrometer tested for vacuum-tightness.

Please contact us for valuable performance data and information regarding ceramic-to-metal applications . . . no obligation.

ALITE DIVISION

U. S. STONEWARE
AKRON 9, OHIO

New York Office
60 East 42nd St.

12F

It's a tough life

but the sensitive

Fenwal THERMOSWITCH® unit takes it in its stride

This is our 17000 series (we've got 25,000 other variations with the operating ranges from -100°F to 600°F) in use in Master Jet Frymaster. The Fenwal control gives the machine rapid, precise response; greater reliability — even makes it more economical by conserving cooking fat and gas!

Fenwal THERMOSWITCH Temperature Controls are enclosed in a tamper-proof assembly that's built to take grueling punishment — and stay highly accurate, uniformly sensitive throughout the operating range — *and its range is three to five times that of an ordinary thermostat!*

That means you can run your machine at greater speeds . . . your machine will require less maintenance! It means greater flexibility for your machine — greater sales for you — *and all at a low first cost.*

Even the assembly of a Fenwal THERMOSWITCH unit is easier and cheaper! The application of Fenwal THERMOSWITCH units are limitless — they're being used in planes . . . factories . . . ships . . . hospitals . . . homes . . . laboratories — *used almost any place where temperature is a factor and accuracy is a must!*

Drop us a line at Fenwal Incorporated, 2011 Pleasant Street, Ashland, Mass. and we'll send you our catalog MC-135 or our sales engineer, whichever you want.

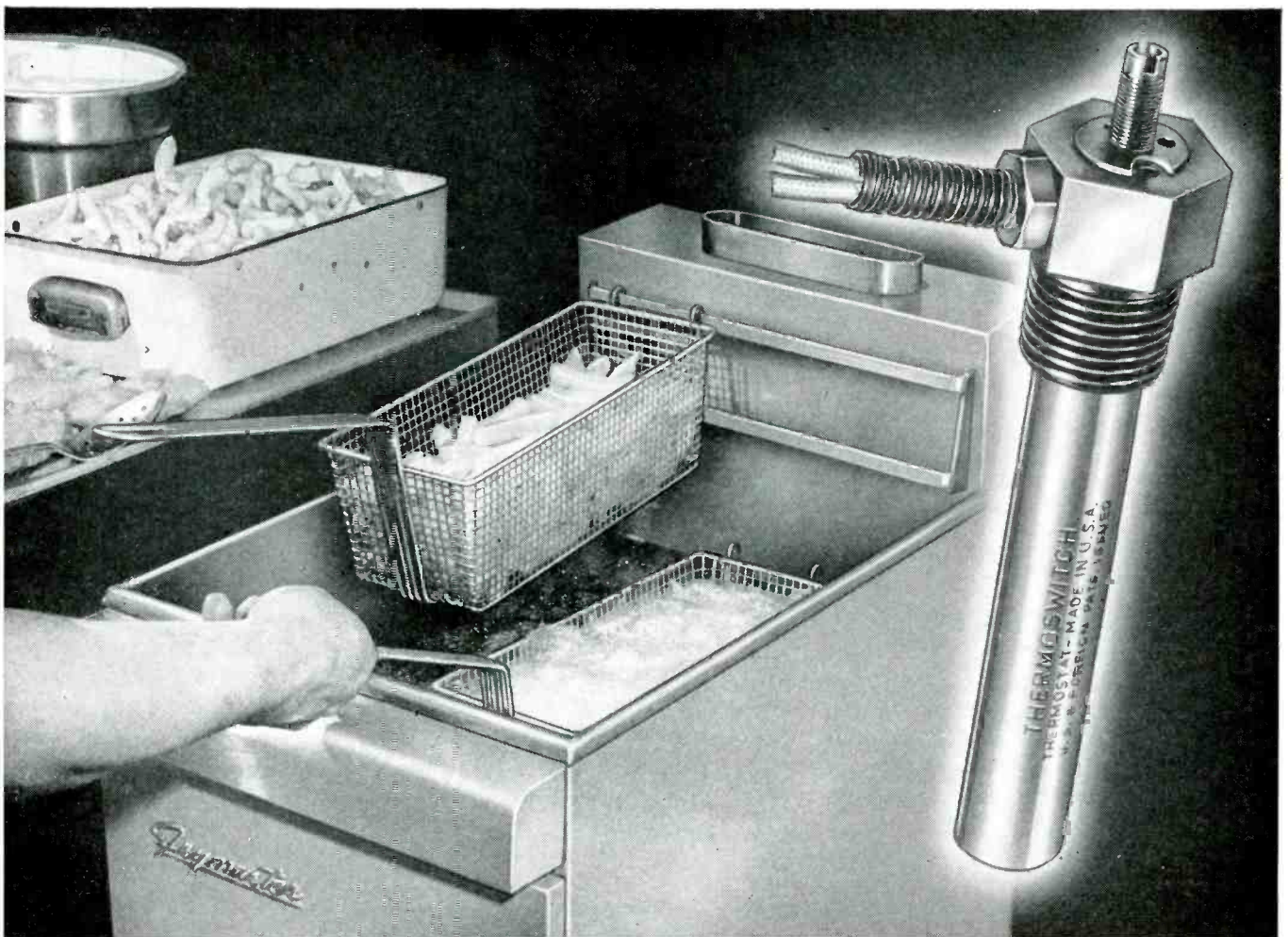

CONTROLS TEMPERATURE...PRECISELY

having your ups and downs?



if they involve EQUIPMENT KNOBS

DALOHM has the answer!

Precision-made Dalohm knobs, incorporating an exclusive collet-fitting design, permit positive locking on the shaft without any of the damaging effects found in other knob securing methods—even when used on soft metal.

You can depend on



TYPE K INDUSTRIAL KNOBS

for hard use at high/low temperatures

- Precision cast of thermo-setting plastic in easy grip shapes
- Knobs fit concentrically on shaft and can be positioned easily and accurately
- Pleasing appearance to match modern styling of apparatus
- Five sizes— $\frac{3}{8}$ ", 1-1/16", 1 $\frac{3}{4}$ ", 2 $\frac{1}{4}$ ", 3"
- Collets interchangeable for shafts $\frac{1}{8}$ " to $\frac{3}{8}$ "
- Highest quality at lowest price
- Standard escutcheons, pointers and indicators available

Write for Bulletin K-29

TYPE MS MILITARY STYLE KNOBS

in accordance with MIL-K-25049

The incorporation of collet-fitting design into military style knobs offers the ultimate in airborne and other military knob applications.

- Maximum locking pressure on shaft eliminates any slippage from vibration or torque
- Precision made of tough, durable thermoplastic material which is fungus proof.
- All metal parts are corrosion resistant
- Designed for flatted shafts
- Complete selection of skirts available as required by
- MIL Specs. Marking of skirts can be to your specific requirements



Write for Bulletin K-35

TYPE MS KNOBS SHOWN ACTUAL SIZE

JUST ASK US!

Write for the complete Dalohm catalog of knobs, precision resistors, and potentiometers.

If none of our standard line fills your need, our staff of able engineers and skilled craftsmen, equipped with the most modern facilities, is ready to help you solve your problem in the realm of development, engineering, design and production. Just outline your specific situation.

**DALE
PRODUCTS
INC.**

1300 28th Ave.
Columbus, Nebraska, U.S.A.

• **Export Dept:**
Pan-Mar Corp.
1270 Broadway,
New York 1, N.Y.

NOW, PRECISION AT A PRICE YOU CAN AFFORD!

2 New Ultra-Stable frequency sources

- Stabilities of better than 1 part in 10^8 per day
- Priced at a fraction of comparable instruments

MANSON MODULAR HIGH STABILITY OSCILLATOR

An exceptionally compact, stable and low-cost crystal-controlled oscillator suitable as a one-megacycle reference source or as a master oscillator in frequency control systems. Its panel-mounted sub-assembly construction meets MIL specifications for construction and environmental temperature range.

SPECIFICATIONS

FREQ. STABILITY: Better than 1 part in 10^8 per day.
FREQUENCY: 1 megacycle, adjustable 10 cycles to compensate for crystal aging and to allow periodic resetting of frequency.
OUTPUT: Sine wave, 1 volt RMS across 50 ohms.
MOUNTING: Standard 19" relay-rack panel, 3½" high, with handles.

Available, less oscillator assembly, as Manson Model RD-130 PROPORTIONALLY-CONTROLLED OVEN SYSTEM for temperature controlling crystals, oscillator circuits, thermocouples and other temperature-sensitive components. This non-cycling system holds oven temperature to within 1/1000 of ambient changes. Oven can be set at any point from 10°C to 100°C above ambient, with vernier adjustments available.

MODEL RD-140

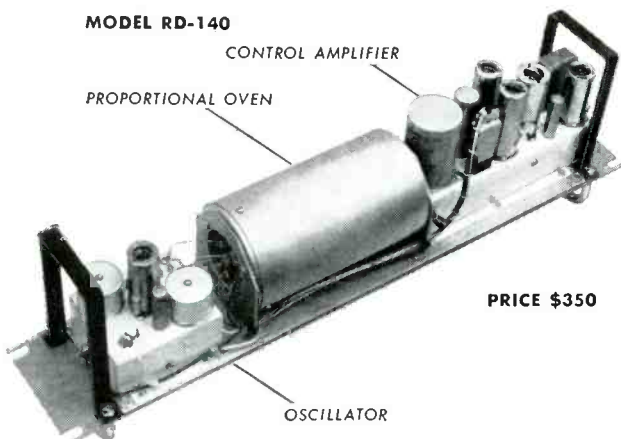

PRICE \$350

Write today for full information

1-MC. HARMONIC REFERENCE OSCILLATOR a laboratory-level frequency standard plus a jitter-free milli-microsecond pulse source for harmonic measurements

A complete, self-contained system for frequency measurement or monitoring. Built-in balanced mixer enables the direct determination of unknown frequencies up to 1000 mc. Unique circuit provides extra wide-range tunability. Non-microphonic design and proportionally-controlled thermo-oven insure exceptional insensitivity to both vibration and temperature. Regulated power supply incorporated.

SPECIFICATIONS

FREQ. STABILITY: Better than 1 part in 10^8 per day.
FREQUENCY: 1 megacycle tunable ± 25 cycles.
TUNING ACCURACY: To 0.1 cps with ultra-linear dial. Direct readout frequency counter assures substantially zero-error readability and resettability.
OUTPUTS: Pulse: Jitter-free, balanced, 40 volts peak across 250 ohms; rise time better than 20 milli-microseconds.
 Sine wave: 3 volts RMS across 50 ohms.
HARMONICS: Usable harmonics extend to the kilomegacycle region.
SIZE: 5¼" H x 19" W x 11¾" D for rack or bench.

MODEL RD-110

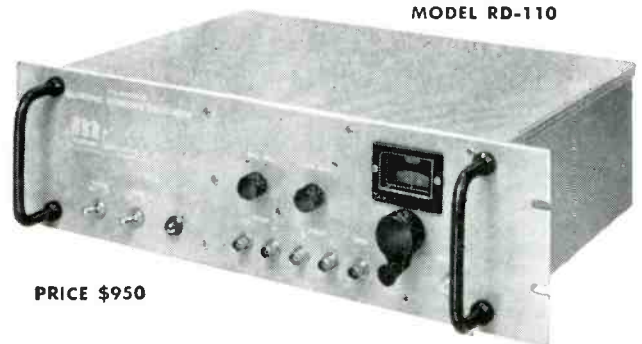

PRICE \$950

100-KC HARMONIC REFERENCE GENERATOR

Model RD-120 available as accessory, providing additional fundamental frequency with jitter-free pulse and sine-wave outputs. Incorporates own mixer and beat-frequency amplifier. Also usable as an independent 100-kc oscillator.

MANSON LABORATORIES
 207 Greenwich Avenue
 Stamford, Connecticut



Manson offers to engineers and technicians a rewarding present and attractive future in suburban Connecticut.

on LAND
at SEA
in the AIR

El Menco

Dur-Mica

CAPACITORS

do the job BETTER!



DM 15
ACTUAL
SIZE

MIGHTY MICAS
Do the Work
of **GIANTS**

Now, Stronger Than Ever . . . give up to 18 years of sure, rugged service!

Put through a series of rough tests, these tiny, tireless workhorses of the electronics industry came up with a record-smashing performance. El-Menco engineers found that El-Menco DM-15, smallest mica capacitor in the world, DM-20 and DM-30 Dur-Mica Capacitors beat all others for long life and tried reliability. Under accelerated conditions of 1½ times rated voltage at 125° C ambient temperature, El-Menco Dur-Micas kept on going strong even after 12,000 hours . . . equal to 18 years or more of service under normal operating conditions.

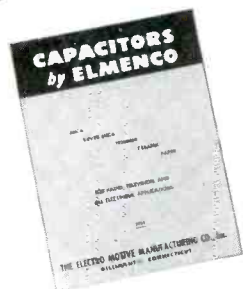

Write for FREE samples and catalog on your firm's letterhead.

El-Menco Dur-Mica DM-15, DM-20, DM-30, DM-40 and DM-42 Capacitors outlive, outperform, outshine . . .

Longer life . . . tremendous power . . . tiny size . . . terrific stability — silvered mica . . . perfect performance. Test them for yourself and see . . .

DM-15 — tiniest mica capacitor in the world . . . ideal for extreme miniaturization . . . up to 820 mmf at 300 VDCW . . . up to 400 mmf at 500 VDCW.

DM-20 — ideal for new miniature designs and printed wiring circuits . . . up to 7500 mmf at 100 VDCW . . . up to 6200 mmf at 300 VDCW . . . up to 4300 mmf at 500 VDCW.



With newly-designed crimped leads . . . Parallel leads simplify use in TV, electronic brains, miniature printed circuits, guided missiles, and countless other applications. El-Menco Dur-Mica Capacitors meet all humidity, temperature and electronic requirements, including military specs.

El-Menco
Capacitors

THE ELECTRO MOTIVE MFG. CO., INC.

Manufacturers of El-Menco Capacitors

WILLIMANTIC CONNECTICUT

- molded mica
- mica trimmer
- dipped paper
- tubular paper
- ceramic
- silvered mica films
- ceramic discs

Arco Electronics, Inc., 64 White St., New York 13, N. Y.

Exclusive Supplier To Jobbers and Distributors in the U.S. and Canada



NEW General Electric M-2 Leak Detector Offers You

UNSURPASSED LEAK SENSITIVITY

Expensive rejects of sealed electronic products can be reduced by leak testing housings before assembly with the new General Electric mass spectrometer leak detector. It offers:

EXTREME SENSITIVITY—detects leaks of 1×10^{-10} standard cubic centimeters of air per second (9×10^{-6} micron cubic feet per hour).

FAST RESPONSE—as low as 2 seconds for small, hermetically sealed electronic components.

HIGH RESOLUTION which helps eliminate the possibility of response to elements other than the tracer gas.

THESE EASY MAINTENANCE FEATURES HELP REDUCE DOWN-TIME

SIMPLIFIED DESIGN of the vacuum system and use of plug-in components gives excellent accessibility and saves maintenance time. The easily removed spectrometer tube greatly reduces down-time when the tube needs cleaning or filament replacement.

NO SPECIAL TRAINING is needed to operate the General Electric M-2 leak detector. After starting, the M-2 is operated simply by opening and closing one valve. The leak will show up on the leak rate indicator of the operator's panel. An audible alarm is also available.

FOR FURTHER INFORMATION, contact your nearest General Electric Apparatus Sales Office or write for descriptive bulletin, GEC-336, to Section 585-63, General Electric Co., Schenectady 5, N. Y.

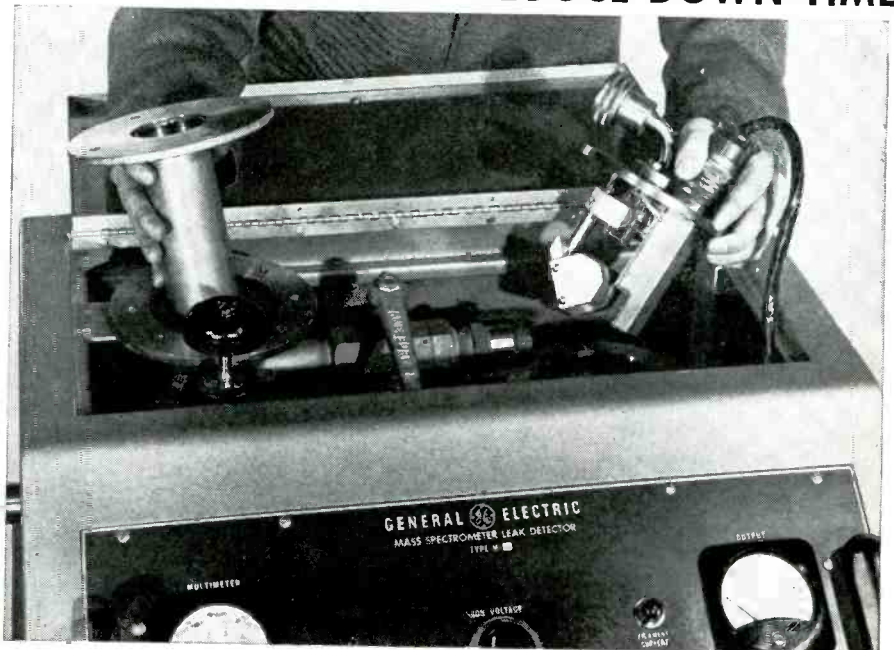

DOWN-TIME IS REDUCED through easy access and removal of the spectrometer tube (right) and by a simplified vacuum system design.

GENERAL ELECTRIC

Compact power relay— high contact ratings

More relay for your money—that's the big thing you get when you specify Ward Leonard's Bulletin 105 for light power switching jobs.

No delicate, misapplied telephone- or instrument-type relay, the 105. From rigid phenolic base to ample silver-to-silver, self-cleaning contacts, the 105 is built to deal with *power*... just like the larger Ward Leonard relays and contactors. And yet it's extremely compact and low in cost.

You'll find the Bulletin 105 relay—in SPST, SPDT, DPST, and DPDT types—ideal for controlling power to electric heaters, signals, pumps, radio and tv transmitters and public address systems.

Check your catalog file today for Bulletin 105. If it's missing write to: Ward Leonard Electric Co., 30 South Street, Mount Vernon, N. Y. (In Canada: Ward Leonard of Canada Ltd., Toronto.)

7.1

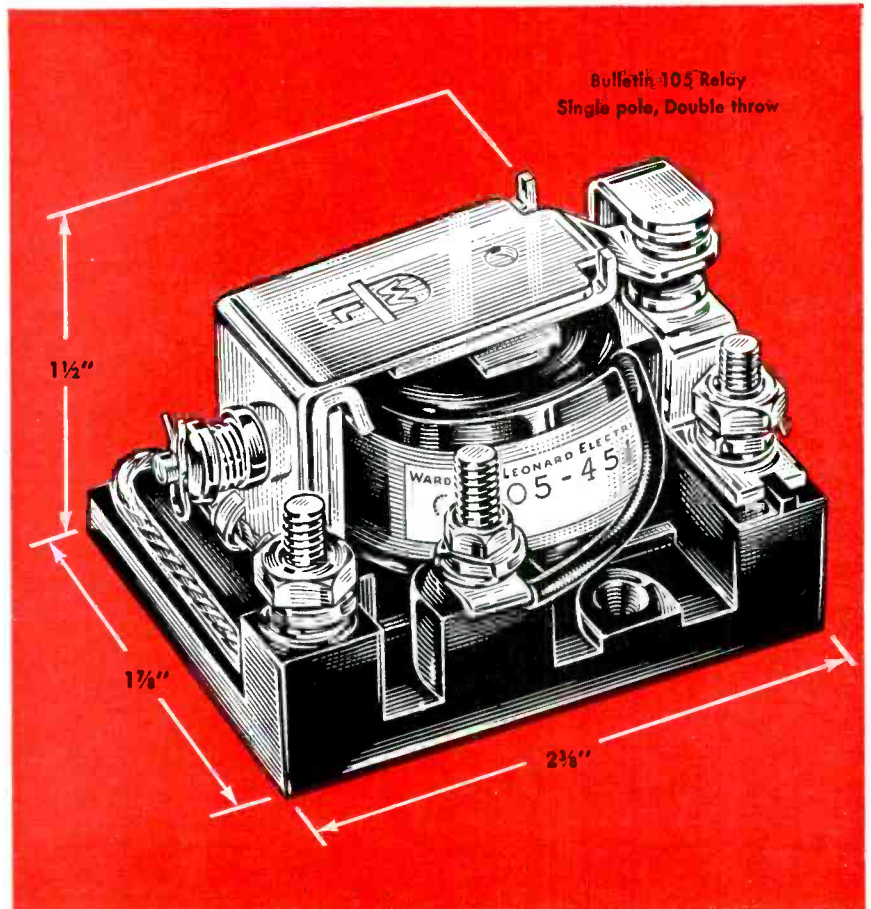

ENGINEERING DATA

SINGLE POLE BULLETIN 105 RELAY

Contact Ratings

Volts	D.C. Amps.*		A.C. Amps.*	
	N.O.	N.C.	N.O.	N.C.
0-24	20	15	20	15
25-125	1/2	1/2	20	15
126-250	—	—	15	10

*Ratings are non-inductive.

COIL VOLTS: 6, 8, 10, 12, 24, 32, 48, 115, 230

AVG. COIL WATTS: 2 D.C., 3.75 A.C.

PICK-UP: 85% or less of rated voltage

WEIGHT: 5 ounces

TERMINALS: Stud type

LIVE BETTER...*Electrically*



**WARD LEONARD
ELECTRIC COMPANY**
MOUNT VERNON, NEW YORK



RESISTORS



RHEOSTATS



RELAYS



CONTROLS



DIMMERS

Revolt-**E**ngineered Controls Since 1892

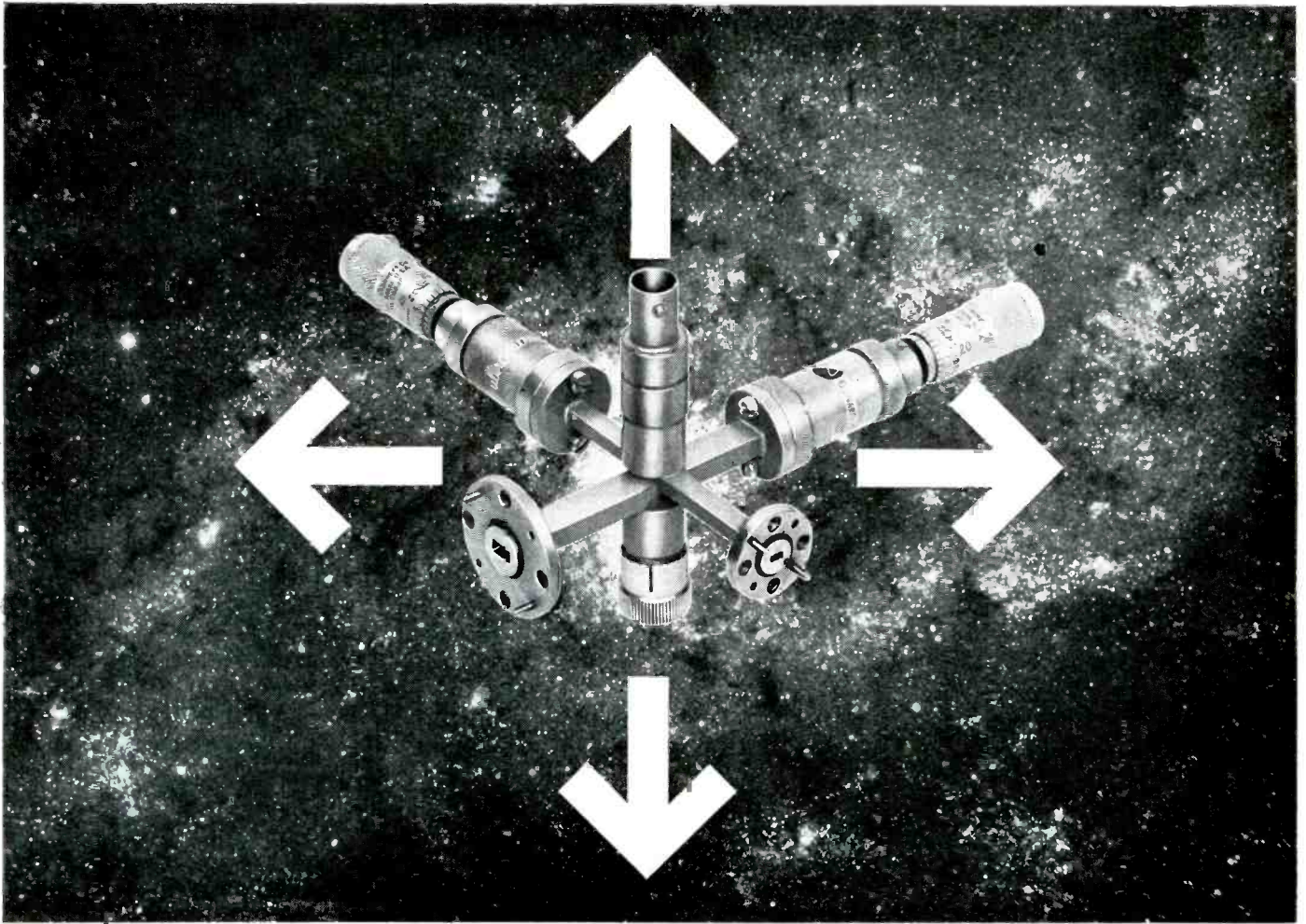

MICROWAVE RESEARCH EXTENDED TO 140,000 MC!

now you can enter Ultramicrowave research with this complete new line of D-B test instruments*

Now microwave engineers can plunge into new research territory. With this 140 KMC Crystal Multiplier (harmonic generator) to provide higher frequencies, and eleven other instrument sizes available for testing, researchers can experiment with 50% more latitude.

For example, you can build working models only 1/10 actual size. You can get better resolution with these higher frequencies—better by 10 to 1.

Here are crystal mounts, precision attenuators, variable stub tuners, standing wave detectors, phase shifters, frequency

meters—every type of instrument used from 2.6 KMC to 90 KMC. All are now available in continuous coverage to 140 KMC!

No matter what your research field, it will pay you to consider the application of ultramicrowaves to your problems. De Mornay-Bonardi will help your staff plan special systems, and set up test equipment. You'll be receiving experienced assistance, too—14 years of leadership in microwave instruments.

WRITE FOR FURTHER INFORMATION

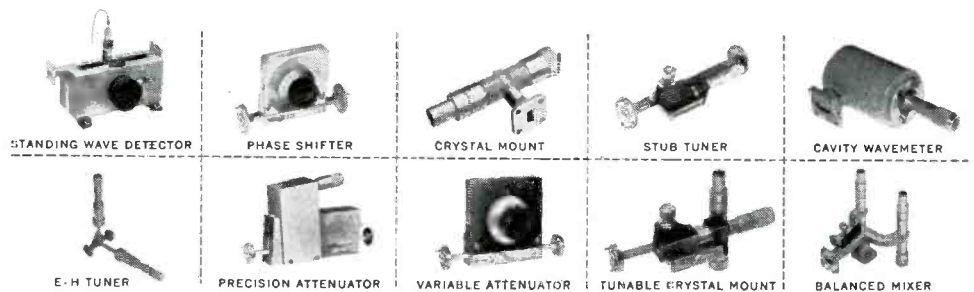

*TRADE MARK DE MORNAY-BONARDI CORPORATION

DE MORNAY-BONARDI 780 s. arroyo parkway • pasadena, california

Circle 64 Readers Service Card

Circle 65 Readers Service Card →

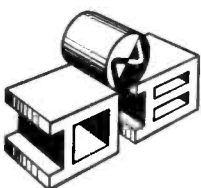

GENERAL  ELECTRIC

TUBE DESIGN NEWS

FROM THE RECEIVING TUBE DEPARTMENT OF GENERAL ELECTRIC COMPANY

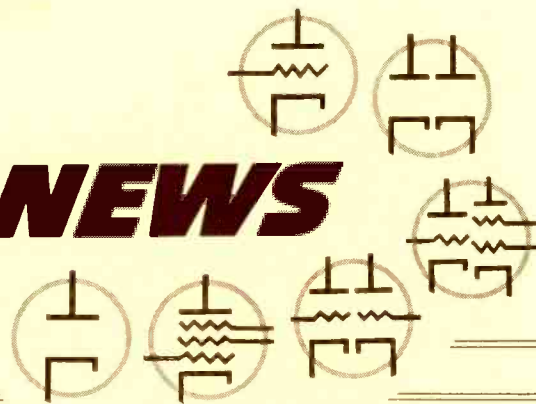

Three New General Electric Tubes Cut Automobile Radio Costs, Simplify Circuitry, Improve Reception

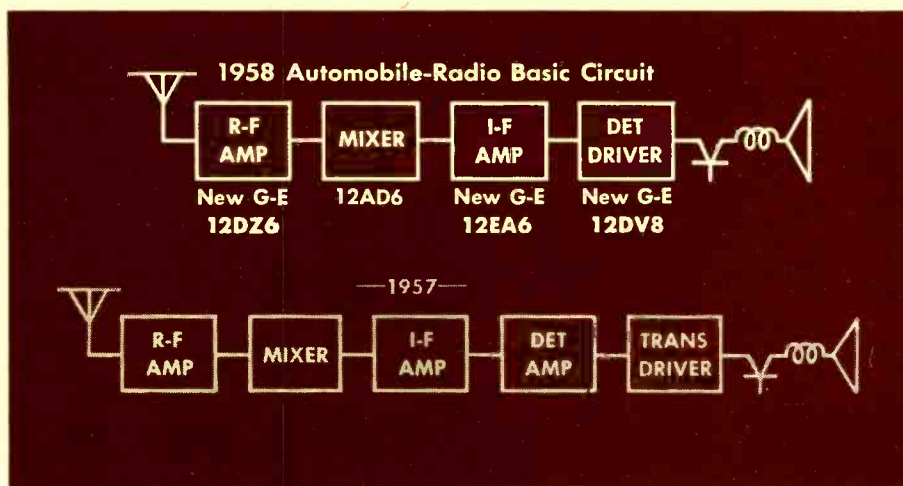

EXTRA-SENSITIVE PERFORMANCE IN 1958 CAR RADIOS—YET FEWER TUBES!

A G-E 9-pin miniature detector-driver tube now does the work of both the detector-amplifier and transistor-driver tubes formerly used. At the same time, new high-gain G-E r-f and i-f amplifier tubes materially increase sensitivity, for clearer reception.

Two years' creative design and development by G-E tube engineers, who worked in close cooperation with the major manufacturers of automobile radios, stand back of three new high-gain tubes that make 1958 car radios more economical to build, with fewer sockets. From the time 12-volt vibratorless radios appeared, frequent conferences between car-radio designers and G-E tube engineers have called into play the latest and best in tube thinking. The G-E 12AF6 was one important outcome. This was 1956's largest-selling new receiving tube!

Now . . . a year later . . . General Electric promotes still higher standards of car-radio performance with Types 12DZ6, 12EA6, and 12DV8. Phone any G-E tube office on the next page for full information.

Noise Rejection is Design Feature of G-E Twin Pentodes 3BU8 and 6BU8

Showing by their performance how up-to-the-minute tube engineering can benefit the TV manufacturer—reduce his costs, improve picture quality—General Electric's 3BU8 and 6BU8 are thrifty multi-function tubes that within a single envelope, perform both noise-cancellation and AGC functions.

Turn page to study the recommended application of these tubes! Oscilloscope readings are included—also plate-characteristics curves—in order to aid television circuit designers.

35,000,000th 5-Star Tube Milestone in High Reliability



RIGHT: R. M. Duncan, manager of General Electric's Owensboro, Ky., tube plant (second from right), and two of his staff inspect the 35,000,000th 5-Star high-reliability tube, a 5670, which has just passed its initial electrical-characteristics tests. Record high total for these tubes proves their wide use in critical military, airborne, and industrial applications.

Tear off and keep this sheet for reference. It contains useful tube-application data

Developed and designed by G.E., Types 3BU8 and 6BU8 are twin pentodes that provide outstanding low-noise performance, with economy. The two tubes are identical except for heater ratings (3.15 v, 6.3 v). Also, the 3BU8 has controlled heater warm-up for service in 600-ma series-string circuits.

Cathode, Grid No. 1, and screen grid are common for both sections of the 3BU8 and 6BU8. Use of a

common No. 1 grid makes possible the rejection of noise pulses from both tube sections. The recommended application for these G-E twin pentodes is: one section, AGC keyer or amplifier . . . the other section, combined sync amplifier, separator, and clipper.

Reproduced below from photographs, are scope readings of tube performance, element by element, in this recommended application.

AGC VOLTAGE OUTPUT

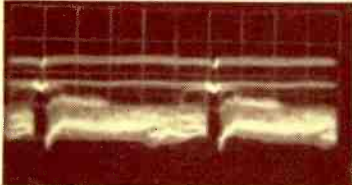

DIRECT-COUPLED COMPOSITE VIDEO (POS.-GOING SYNC)

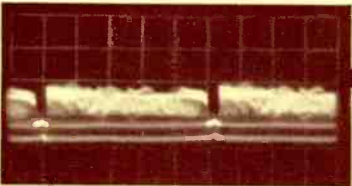

LEFT: COMPOSITE VIDEO FOR NOISE CANCELLING (NEGATIVE-GOING SYNC)

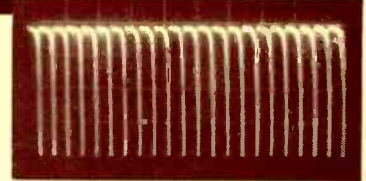
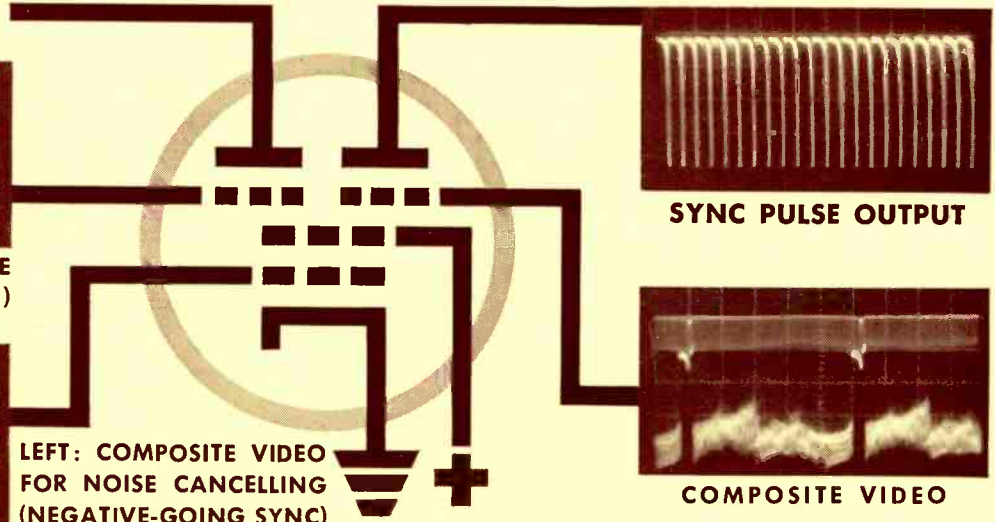

SYNC PULSE OUTPUT

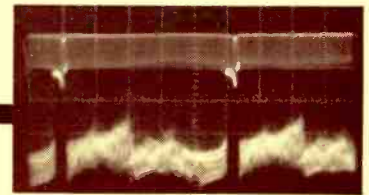

COMPOSITE VIDEO

SHOWN BELOW ARE AVERAGE PLATE CHARACTERISTICS, TYPES 3BU8 AND 6BU8

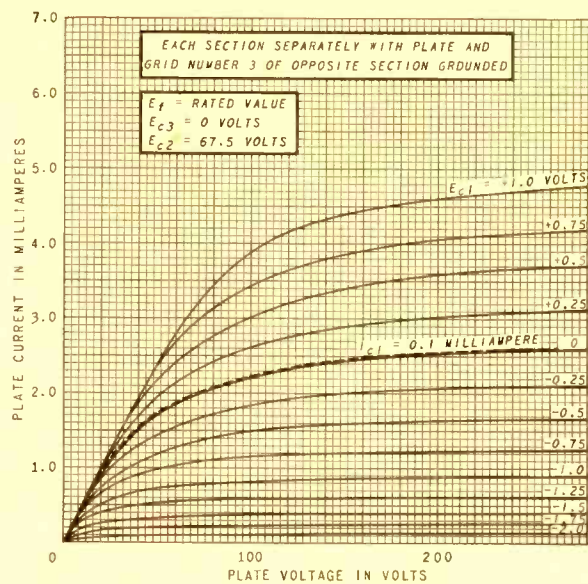
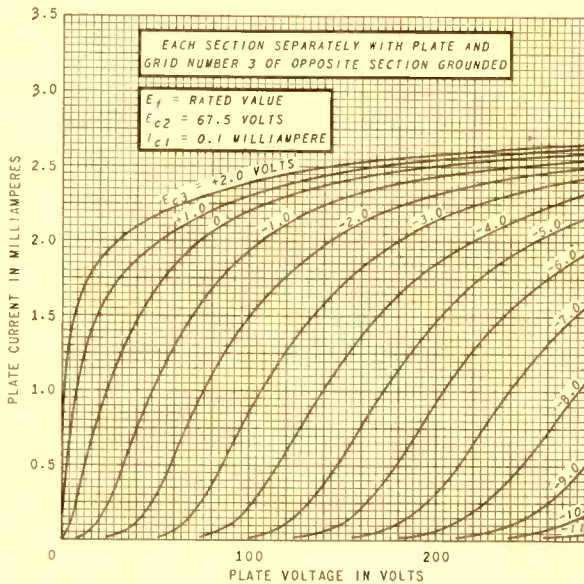

For further information, write or phone your nearest G-E tube office below:

EASTERN REGION

200 Main Avenue, Clifton, New Jersey
Phones: (Clifton) GRegory 3-6387
(N.Y.C.) Wlconsin 7-4065, 6, 7, 8

CENTRAL REGION

3800 North Milwaukee Avenue
Chicago 41, Illinois
Phone: SPring 7-1600

WESTERN REGION

11840 West Olympic Boulevard
Los Angeles 64, California
Phones: GRanite 9-7765; BRadshaw 2-8566

Progress Is Our Most Important Product

GENERAL  ELECTRIC

162-1C7

RECEIVING TUBE DEPARTMENT, GENERAL ELECTRIC COMPANY, OWENSBORO, KENTUCKY

NEW HIGHER TORQUE MULTI-FUNCTION SYNCHROS SURPASS MIL ACCURACIES



Higher Torque • Higher Accuracy • Multi-function Versatility

Systems engineers can now gain *simplicity and better performance in torque synchro systems* by using new synchros developed by Norden-Ketay for the Bureau of Ordnance. The unique design reduces error by approximately one-half while increasing torque 2 to 3 times in comparison with standard Mil synchros. By performing interchangeably as Torque Transmitters and Receivers, these synchros offer the further advantage of systems simplification. This new development by Norden-Ketay *extends the capabilities of the systems designer to advance beyond previous limits of performance.*

- **Higher Torque Gradient** —
2 to 3 times previous mil spec values.
- **Higher Electrical Accuracy** —
Size 15: $\pm 6'$ compared with $\pm 12'$ (Mil)
Size 18: $\pm 5'$ compared with $\pm 8'$ (Mil)
- **Multi-function Versatility** —
Torque and Accuracy values excel Mil torque transmitters and receivers. These synchros can be used interchangeably in both functions with improved system performance.
- **Greater Dynamic Accuracy** —
Higher torque provides receiver error of $\pm 1.0^\circ$ max. throughout the life of the unit.



Sales Offices: STAMFORD, CONN.
CHICAGO, ILL. • LOS ANGELES, CAL.
WASHINGTON, D.C. • DAYTON, OHIO

For full data and application engineering on these new multi-function synchros, write to Norden-Ketay Corporation, Precision Components Division, Commack, Long Island, N.Y.

FUNCTION	UNITS	NEW MULTI-FUNCTION SYNCHROS	STANDARD MIL SYNCHRO	NEW MULTI-FUNCTION SYNCHROS	STANDARD MIL SYNCHRO
NORDEN-KETAY TYPE		105C2E1	105C2A3	108C2C2	108C2B1
SIZE		15	15	18	18
Number of Phases	{ STATOR ROTOR	3	3	3	3
		1	1	1	1
EXCITATION PHASE		Rotor	Rotor	Rotor	Rotor
FREQUENCY	cps	400*	400	400*	400
VOLTAGE RATING	volts	115/90	115/90	115/90	115/90
Maximum Input	{ CURRENT POWER	0.20	0.176	0.50	0.275
		3.0	3.1	5.5	4.1
INPUT IMPEDANCE	ohms	680/83°	715/81°	235/84°	460/83°
FRICTION TORQUE AT 20°C MAX.	oz. in.	0.05	—	0.05	—
ELECTRICAL ERROR, MAXIMUM	minutes	± 6	± 12	± 5	± 8
RECEIVER ERROR, MAXIMUM	degrees	± 1.0	± 1.0	± 1.0	± 1.0
TORQUE GRADIENT, MINIMUM	oz-in/deg	0.026	0.013	0.10	0.036
DAMPING TIME, MAX. (179°)	seconds	2.0	2.5	2.0	2.0
OPERATING TEMP. RANGE	°C	-55° to +55°C (Available on special order to 125°C and 200°C)			
WEIGHT	oz.	7.2	6.4	10.0	9.0
MIL DESIGNATION		15TR4b	15TR4a	18TR4b	18TR4a

*Although these synchros are rated at 400 cps, they are available to your order to operate at any frequency from 400 cps to 10,000 cps.
Data at extremes of temperature available upon request.

also
A COMPANY IS KNOWN

... BY THE FACILITIES IT KEEPS



FLUSHING, N. Y., PLANT NO. 1

FLUSHING, N. Y., PLANT NO. 2

East to West... Flushing, New York, to Culver City, California

On Filtron's Staff: Engineering specialists in component design, development and production. . . In Filtron's Plants: The most modern and completely equipped laboratories for research and testing, to MIL specifications; high speed quality manufacturing

and assembly. . . In the Field: Competently staffed mobile engineering laboratories to solve problems on-the-job at complex electronic installations.

From
FILTRON'S
5
PLANTS

- RF INTERFERENCE FILTERS
- RF FIELD ENGINEERING SERVICE
- RADAR PULSE PACKAGES
- PULSE FORMING NETWORKS
- SPECIALTY CAPACITORS
- DELAY LINES

Send for our catalog

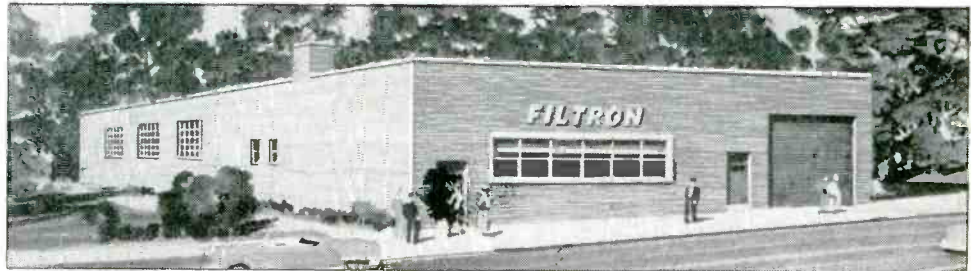

FLUSHING, N. Y., PLANT NO. 3

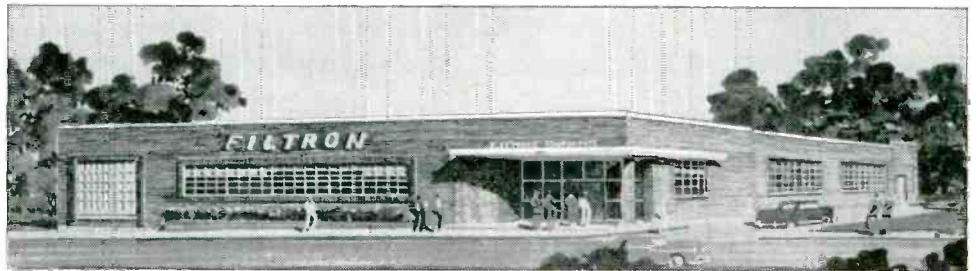

CULVER CITY, CAL., PLANT NO. 1

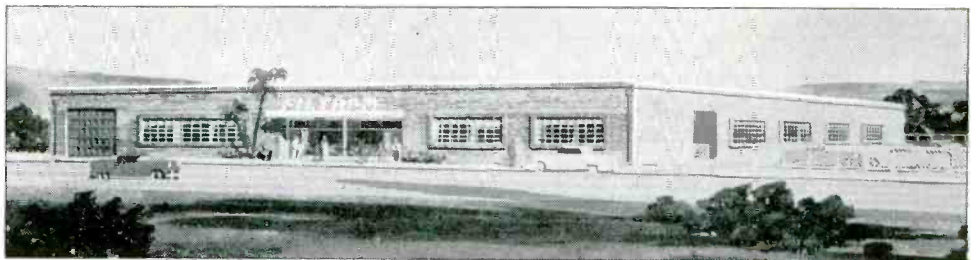

CULVER CITY, CAL., PLANT NO. 2

FILTRON IS KNOWN FOR ITS PRODUCTS... THE FACILITIES WE KEEP EXPLAIN WHY

REPRESENTED IN CANADA BY: AIRCRAFT APPLIANCES & EQUIPMENT LTD.
 585 Dixon Side Road, Toronto

FILTRON COMPANY, INC.
FLUSHING, LONG ISLAND, NEW YORK
PLANTS IN FLUSHING, NEW YORK, AND CULVER CITY, CALIFORNIA

TWO OF FILTRON'S COMPLETELY EQUIPPED MOBILE LABORATORIES

RECTIFIERS—Both vacuum and gas filled tubes with peak inverse voltage ratings from 200 to 15,000 volts. Included are tubes with special features such as fast warm-up, cold cathodes, clipper service ratings and rugged construction.



TELEPHONE TYPES — A highly specialized line of vacuum and gas filled types in both the 300 and 400 series.



THYRATRONS—An extensive line of thyratrons for use as grid control rectifiers, relays and noise generators. Inverse voltage ranges from 100 to 5,000 volts. Sizes from subminiatures to ST 16 bulbs. Filamentary as well as hot and cold cathode types are available.



VOLTAGE REGULATOR AND REFERENCE TUBES—Gas filled tubes designed to specific voltages for regulating small currents. Also used to make available stable reference voltages for high current supplies. Sizes from subminiatures to bantams, including many reliable, ruggedized types.

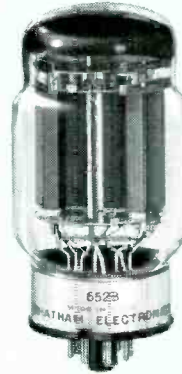

TWIN POWER TRIODES—The most complete line of high current twin power triodes developed especially for regulated power supply usage. Current and power ranges up to 800 milliamperes and 60 watts respectively. Included are rugged types in both low and medium mu construction.

HYDROGEN THYRATRONS—Used primarily as switching tubes in line type radar modulators, these tubes permit accurate control of high energy pulses. Sizes from miniatures to the VC 1257. Peak pulse power ranges from 10 kilowatts to 33 megawatts.

EXPANDS TO MEET INCREASED SPECIAL PURPOSE TUBE DEMANDS

100,000 Square-Foot Addition Doubles Existing Facilities

The creative engineering that has been responsible for many Chatham "originals", now has larger and improved facilities to help you solve your special purpose tube problems.

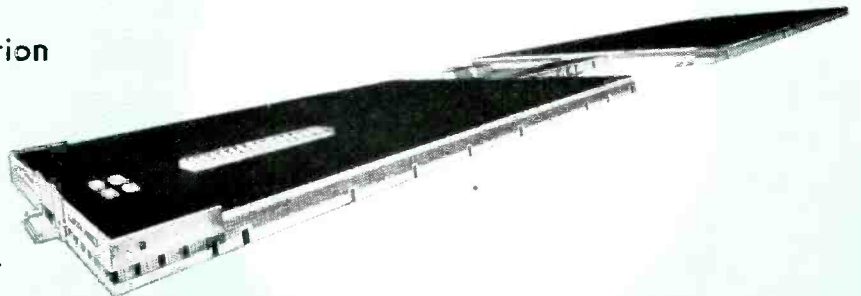

CHATHAM ELECTRONICS Division of TUNG-SOL ELECTRIC INC.

General Office and Plant: Livingston, New Jersey
SALES OFFICES: CHICAGO, DALLAS, LIVINGSTON, LOS ANGELES



HERE'S THE MOVE TO MAKE

for Skilled Help On
ELECTRO-MECHANICAL EQUIPMENT

Bring your designs for electro-mechanical assemblies and components to Atlas Precision—as many industry leaders do—for experienced and skillful engineering help from idea stage to production line.

Atlas Precision can provide "precision-eering" on all types of electro-mechanical devices—from automatic control devices to radar ... to computing systems ... to automation ... to electronics. It puts at your command design, product and methods engineers, toolmakers and skilled mechanics—as many men, machines and work-hours as your job requires *and no more*. Most modern cost-cutting tools and techniques are used. Atlas mechanical and electronics engineers thoroughly test your product. Complete facilities are available for taking your project from pilot stage to production efficiency.

Write for a copy of "Precision-eering Electro-mechanical Equipment" to

ATLAS PRECISION PRODUCTS CO.
PHILADELPHIA 24, PA.
(Division of Prudential Industries)



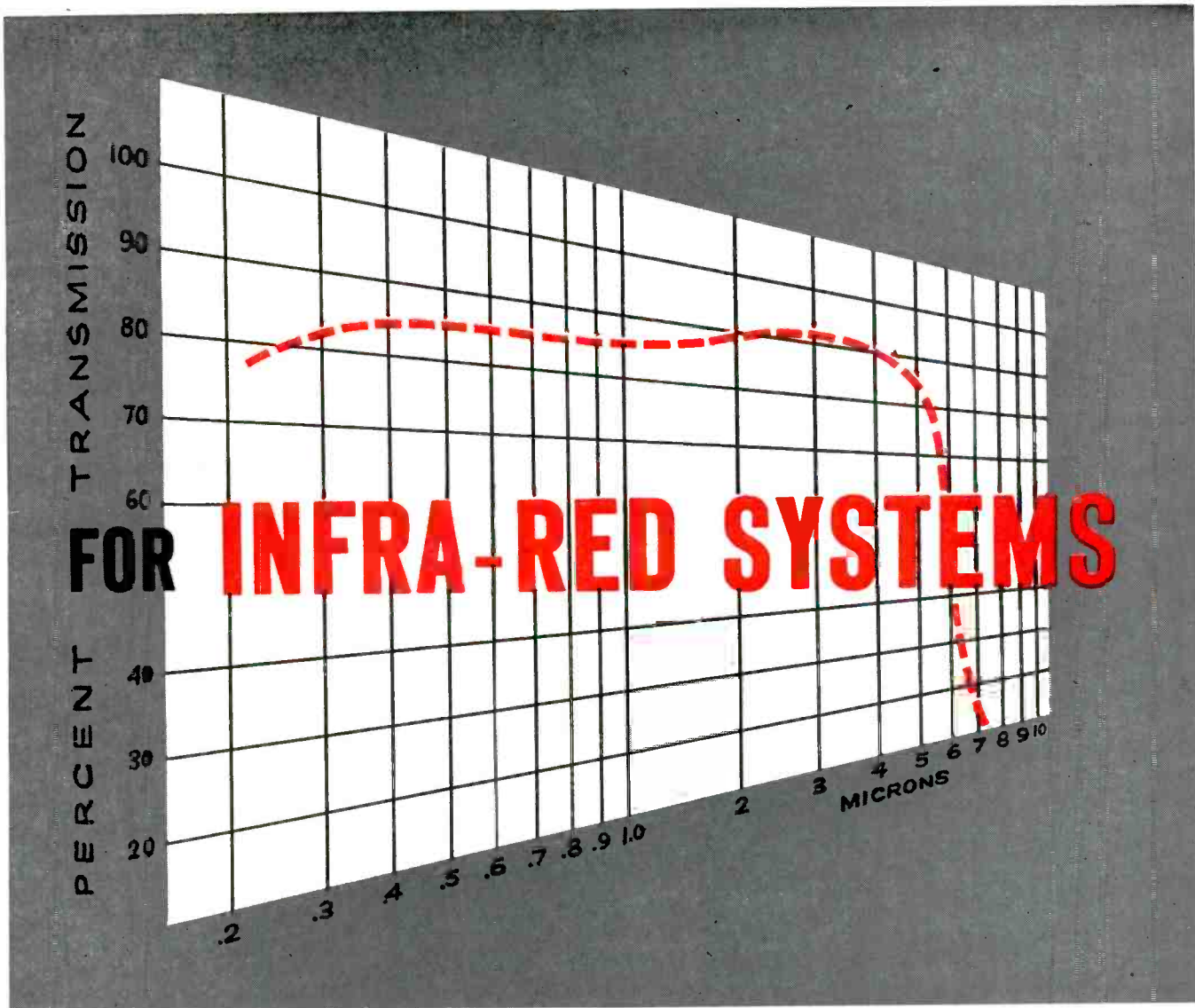

SPECIFY **LINDE** Sapphire

TRADE-MARK

LINDE Sapphire is ...

Hard—Moh 9
 Transparent, single crystal, pure aluminum oxide
 Nonporous—0% porosity
 Easily sealed to metals and ceramics
 Priced competitively with sintered materials

LINDE Sapphire has ...

Strength at elevated temperatures
 High melting point—2040° C.
 Excellent IR transmission at high temperatures (above 500° C.)

LINDE Sapphire is available as ...

Windows
 Domes
 Rods and tubes
 Special shapes—to order

For more information about LINDE Sapphire . . . Write "Crystals Dept. BD-11," LINDE COMPANY, Division of Union Carbide Corporation, 30 East 42nd Street, New York 17, N. Y. *In Canada:* Linde Company, Division of Union Carbide Canada Limited

Linde

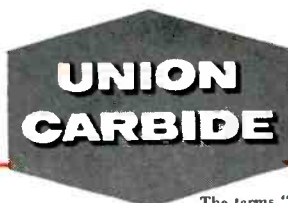

ENGINEERS AND SCIENTISTS interested in working in Synthetic Crystal Sales & Development, contact Mr. A. K. Seemann, Linde Company, 30 E. 42nd St., New York 17, N.Y.

The terms "Linde" and "Union Carbide" are registered trade-marks of Union Carbide Corporation.

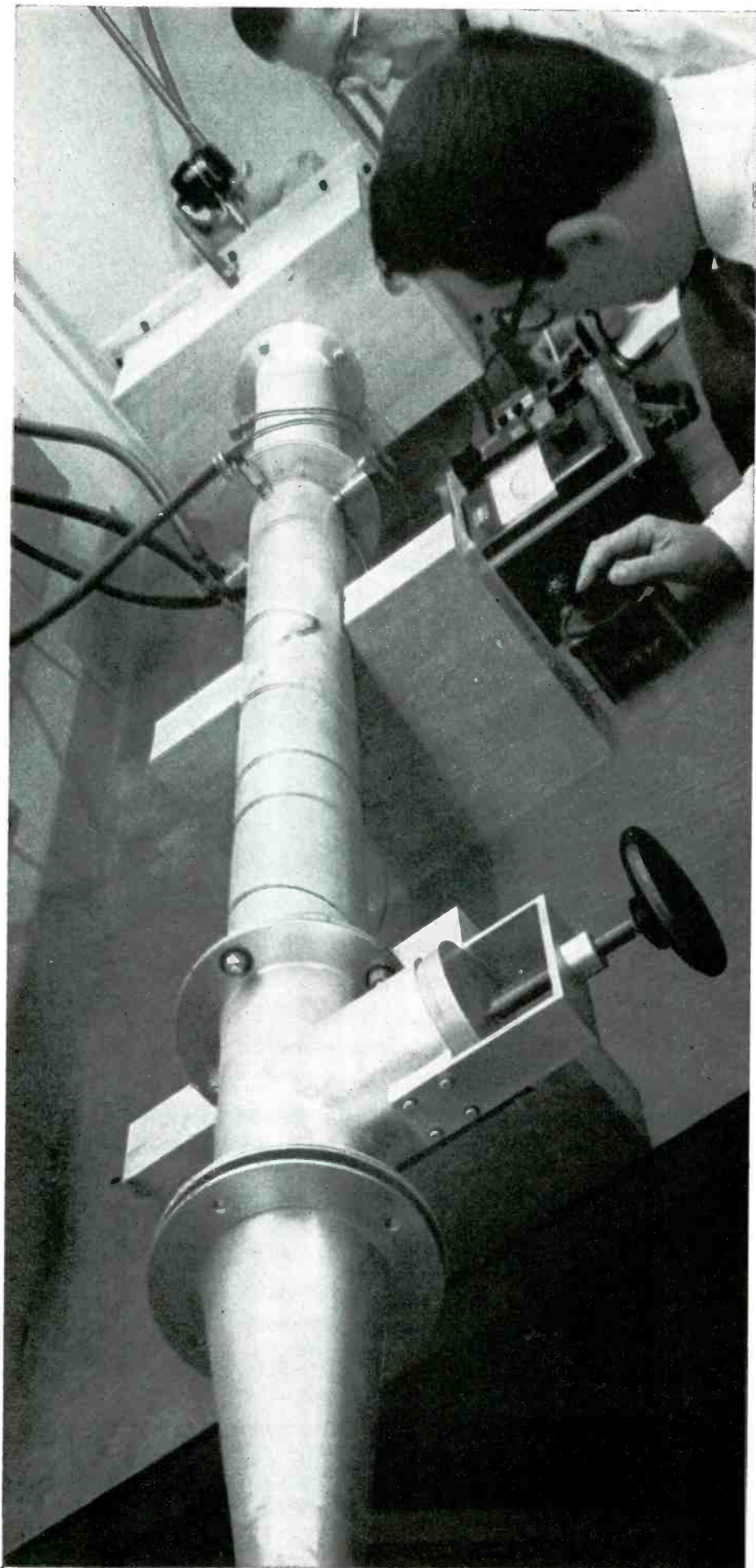

**HOW MUCH TIME
DOES AN
ENGINEER-WRITER
SPEND NOT
WRITING?**

At Hughes an Engineer-Writer is given the latitude to thoroughly investigate a system. By actual statistics, he spends 80% of his time researching. Only 20% is spent writing.

To gain an over-all understanding of the Airborne Electronics Armament System—which includes the Falcon Missile, digital computers, and microwave components—he discusses the theoretical considerations with Research and Development Engineers, often during the preliminary design stage. He learns, through intensive circuit and systems analysis, how the equipment operates. He does liaison with Field Engineers on maintenance techniques. As a result of this investigation, his writing fully utilizes his background.

The Engineer-Writer at Hughes does only the professional type of work, being supported by a staff which includes artists, editors, technicians and typists.

If this type of work interests you, investigate Hughes. You'll receive a good salary, opportunities for advancement, and an excellent program of fringe benefits, including Hughes-sponsored evening classes. Act today . . . write, briefly outlining your experience, to

The West's leader in advanced electronics

HUGHES

**RESEARCH AND
DEVELOPMENT LABORATORIES**

SCIENTIFIC STAFF RELATIONS, BLDG. 5B

Hughes Aircraft Co., Culver City, California



Subminiature Hughes silicon power rectifiers pictured with some of the standard vacuum tubes they replace.

Body diameter: 0.105-inch max.
Body length: 0.265-inch max.

NEW, AT HUGHES
LOW-POWER RECTIFIERS
WITH HIGH-VOLTAGE CAPABILITIES

Once again, Hughes has supplemented its line of silicon rectifiers—this time, with units rated up to 600 volts yet using the famous Hughes subminiature glass package. Like other Hughes rectifiers, these have the advantages of low forward voltage drop and low back leakage enabling them to handle power values that are large for the size of the rectifier. Features of this kind, combined with exceptional efficiency, make them ideal for electronic power supply applications where they can be used in place of many vacuum tube rectifiers.

Descriptive literature for the entire rectifier series is available upon request. Please write:

SEMICONDUCTOR DIVISION • HUGHES PRODUCTS
International Airport Station, Los Angeles 45, California

SPECIFICATIONS

HR10311
Peak Reverse Voltage (E_b) @ $-2\mu A$ IV 500V @ 25°C
Reverse Current (I_b) @ $-450 Vdc$ IIIA 35 μA @ 150°C
Max. Ave. Inverse Current (I_{bo}) @ 315V_{rms}@ 200mA IV 20 μA @ 25°C
Max. Ave. Rectified Current (I_o) IV 200mA @ 25°C

HR10312
Peak Reverse Voltage (E_b) @ $-2\mu A$ IV 600V @ 25°C
Reverse Current (I_b) @ $-550 Vdc$ IIIA 35 μA @ 150°C
Max. Ave. Inverse Current (I_{bo}) @ 385V_{rms}@ 200mA IV 20 μA @ 25°C
Max. Ave. Rectified Current (I_o) IV 200mA @ 25°C
Maximum operating and storage temperature $-65^\circ C$ to $+150^\circ C$
Derate average rectified current 1.5mA/ $^\circ C$ above 25°C

The HR10311 and HR10312 have the famous glass package developed years ago at Hughes. This package, still the finest available, is tiny, but sturdy, thereby fulfilling all of the requirements for miniaturization while providing reliable operation under severe conditions of shock and vibration.

Creating a new world with *ELECTRONICS*

HUGHES PRODUCTS

© 1957, HUGHES AIRCRAFT COMPANY

HUGHES



SEMICONDUCTORS

**Forethought
costs less than
Afterthought**

so . . .

**Design
These in
When you
Begin!**

If you need mechanical or electrical counters in any of your new products, here's a word to the cost-wise designer: *Design them in, when you begin . . . don't tack them on later.*

For if you'll give us a chance to work with you, right from the beginning, chances are we can save you time and money by adapting or modifying a *standard* Veeder-Root Counter to your needs . . . where you might get into a costly special job if you went about it alone. What's more, you save time in your engineering, purchasing and assembly departments.

Count on Veeder-Root to help you in every way . . . from design to delivery. Write:



**Everyone...
Can Count on
Veeder-Root**

INCORPORATED

Hartford, Conn. • Greenville, S. C. • Chicago
New York • Los Angeles • San Francisco • Montreal
Offices and Agents in Principal Cities

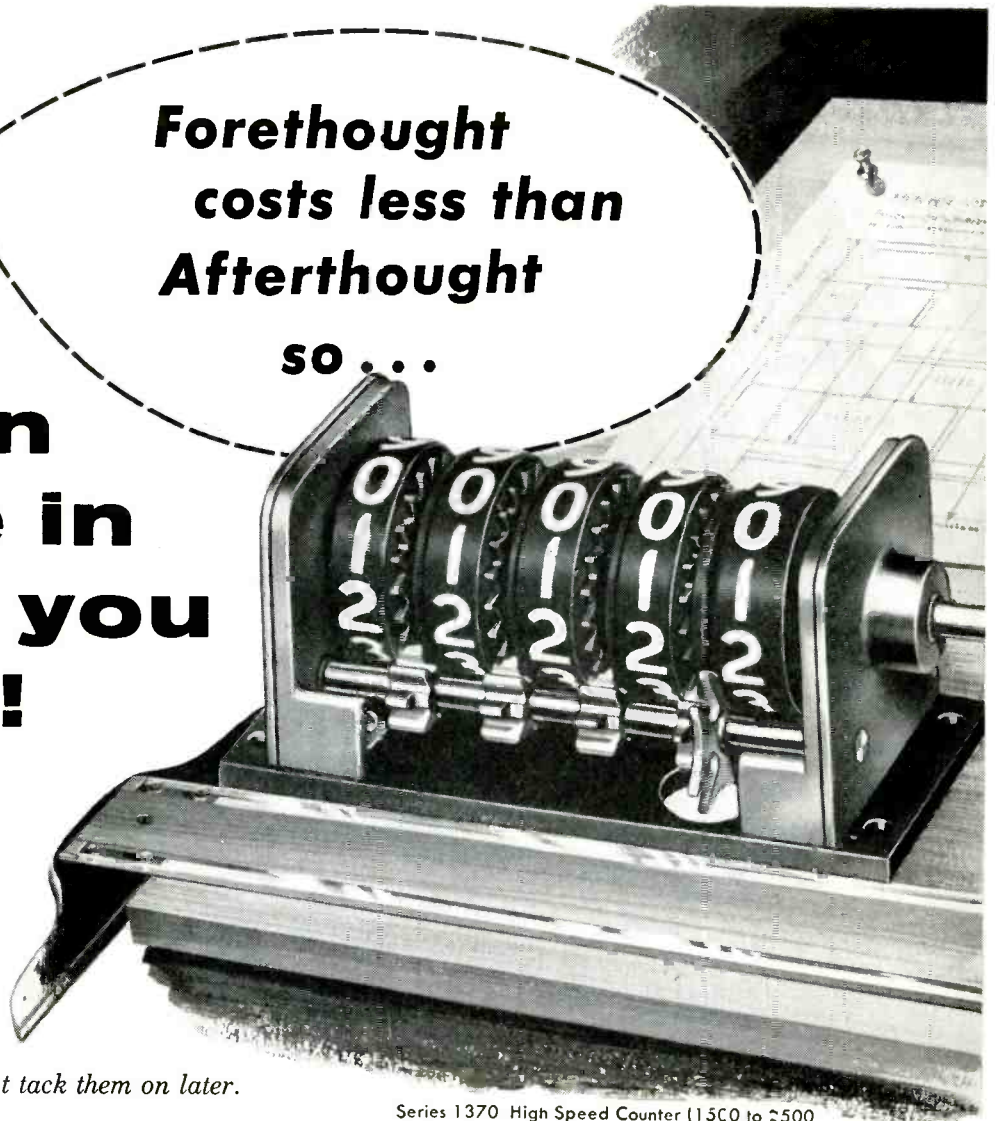

Series 1370 High Speed Counter (1500 to 2500 rpm) built into a wide variety of equipment.

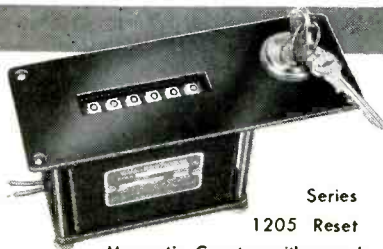

Series 1205 Reset
Magnetic Counter with panel
mount and lock and key.

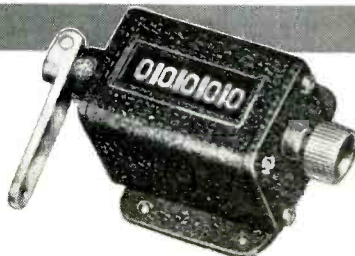

Series 1122 Small Reset Ratchet Counter.

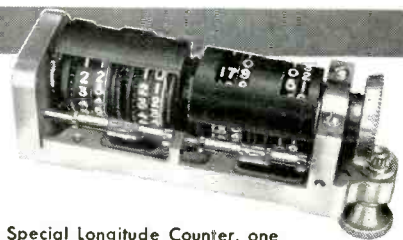

Special Longitude Counter, one of many made for aircraft navigational equipment.

AUTOMATIC

silicon power rectifiers

now
up to
20
amperes!



ACTUAL SIZE

AUTOMATIC
MANUFACTURING

The same high quality and complete reliability that has made the name of Automatic famous in rectifiers is now offered in a new silicon power rectifier—available in 5, 10 and 20 amperes. The prompt service and competitive prices that you are accustomed to from Automatic are applicable for this new unit.

Write today for complete technical information.

ABSOLUTE MAXIMUM RATINGS (For 135°C. Case Temperature)		AM 0505	AM 1005	AM 1505	AM 2005	AM 2505	AM 3005	AM 3505
Peak Reverse Voltage	Vdc	50	100	150	200	250	300	350
RMS Voltage	Volts	35	70	105	140	175	210	245
Average DC Output Current	Amps	5	5	5	5	5	5	5
Peak recurrent forward current	Amps	25	25	25	25	25	25	25
Surge Current (5 seconds)	Amps	15	15	15	15	15	15	15
Forward Voltage drop at 15 amp (Measured at 25°C.)	Volts	1.25	1.25	1.25	1.25	1.25	1.25	1.25
DC Reverse Current at rated PIV	Ma	5	5	5	5	5	5	5

ABSOLUTE MAXIMUM RATINGS (For 135°C. Case Temperature)		AM 0510	AM 1010	AM 1510	AM 2010	AM 2510	AM 3010	AM 3510
Peak Reverse Voltage	Vdc	50	100	150	200	250	300	350
RMS Voltage	Volts	35	70	105	140	175	210	245
Average DC Output Current	Amps	10	10	10	10	10	10	10
Peak recurrent forward current	Amps	45	45	45	45	45	45	45
Surge Current (5 seconds)	Amps	25	25	25	25	25	25	25
Forward Voltage drop at 25 amp (Measured at 25°C.)	Volts	1.25	1.25	1.25	1.25	1.25	1.25	1.25
DC Reverse Current at rated PIV	Ma	5	5	5	5	5	5	5

ABSOLUTE MAXIMUM RATINGS (For 135°C. Case Temperature)		AM 0520	AM 1020	AM 1520	AM 2020	AM 2520	AM 3020	AM 3520
Peak Reverse Voltage	Vdc	50	100	150	200	250	300	350
RMS Voltage	Volts	35	70	105	140	175	210	245
Average DC Output Current	Amps	20	20	20	20	20	20	20
Peak recurrent forward current	Amps	90	90	90	90	90	90	90
Surge Current (5 seconds)	Amps	50	50	50	50	50	50	50
Forward Voltage drop at 50 amp (Measured at 25°C.)	Volts	1.25	1.25	1.25	1.25	1.25	1.25	1.25
DC Reverse Current at rated PIV	Ma	5	5	5	5	5	5	5

MASS PRODUCERS OF ELECTRONIC COMPONENTS

AUTOMATIC MANUFACTURING
DIVISION OF GENERAL INSTRUMENT CORPORATION
65 GOVERNEUR ST.
NEWARK 4, N. J.

Forget leads, insert Wejcap capacitors, see costs of print board assemblies drop

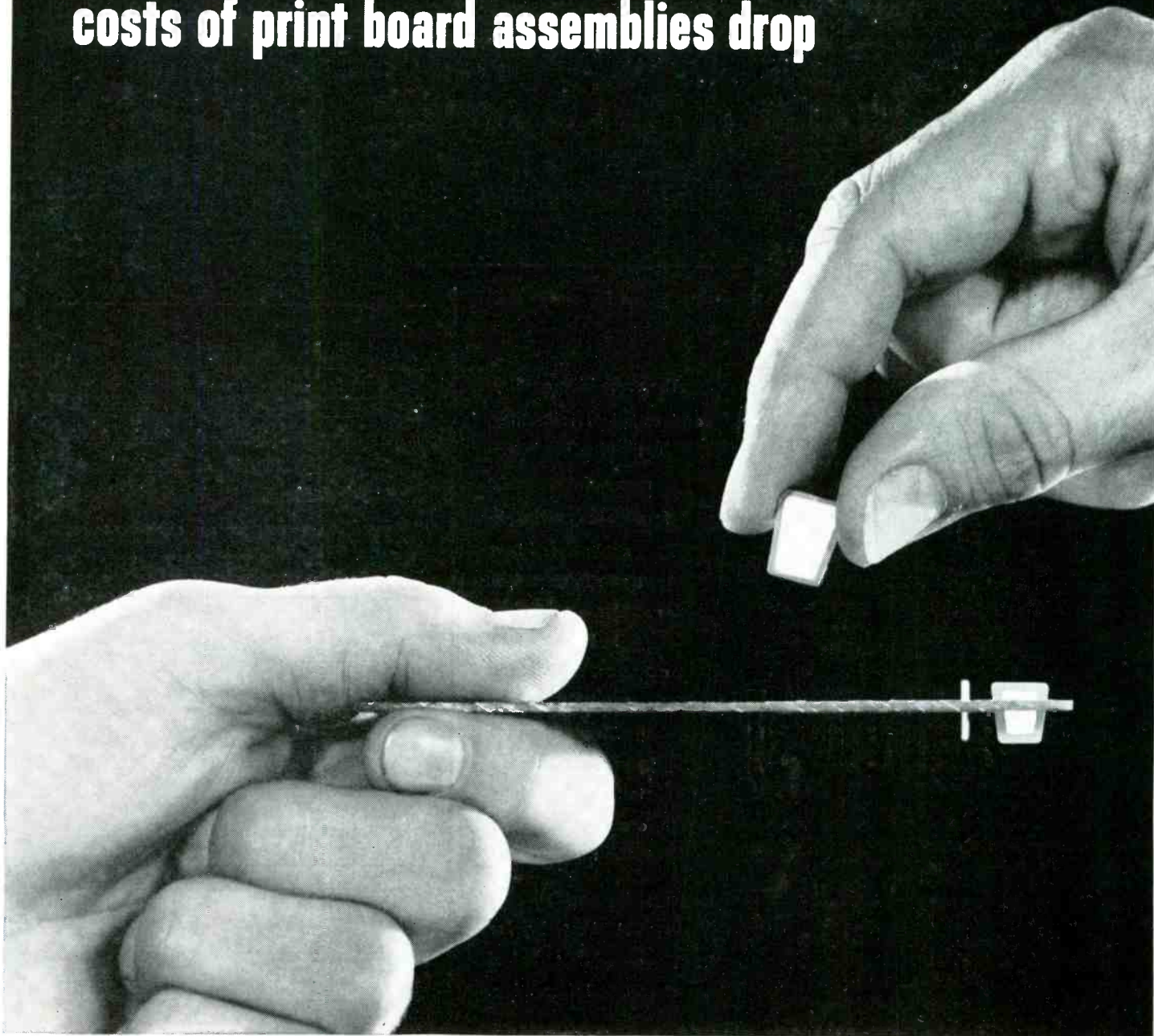

Lead Metaniobate

A piezoelectric material recently developed by General Electric, Lead Metaniobate remains remarkably stable over the temperature range from -54°C to 265°C , an important fact in high-temperature instrumentation devices. It displays superior aging characteristics compared with other ceramic piezoelectric bodies. The high Curie temperature (570°C) allows repeated heat cycling with no effect on electrical output.

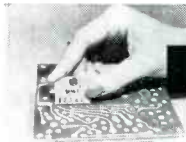

Encapsulated RC Networks

A new series of encapsulated RC networks is now available from General Electric that replaces a host of individual resistors and capacitors. The price saving can be ten percent or better. The assembly saving in print wire boards—inserting one unit instead of five or ten—averages about 67 percent. Furthermore, this small RC network results in a smaller overall assembly, cutting board costs.

New stabilized types or general purpose types cost up to 35% less, resist breakage and moisture.

Wejcap capacitors were specially developed to let you realize more fully the economy and design advantages of printed boards. They are a product of General Electric research into the high density, high strength properties of improved barium titanate. They have no leads to bend or break, or that require extra time to crimp and align. Extensive production use proves Wejcap capacitors are practically unbreakable and resist moisture absorption. They are available in general purpose types, or in the new stabilized types that maintain their value at room temperature to within $\pm 20\%$ of the nominal value.

How much can you save? Wejcap capacitors cost up to 35% less than other capacitors. Production runs show that four Wejcap capacitors can be inserted in the time it takes to put in three ordinary capacitors. The total cost and assembly savings will be appreciable, even if you apply only three Wejcap capacitors to your production chassis.

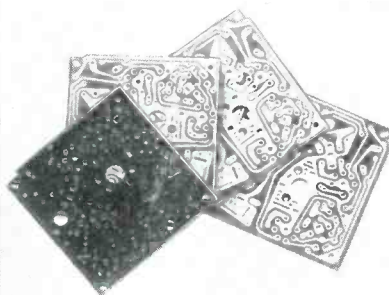

Thru-Con* print wire boards. Now you can design a compact wiring pattern on both sides of the board without the cost of further processing to connect them. The "Thru-Con®" additive technique plates through the holes at the same time it plates the wiring pattern. This permits

high-speed dip soldering remarkably free from rejects. No special eyelets or pre-cleaning are required. Assembly weight is reduced and inventory is simplified.

Sample Wejcap capacitors and other General Electric components—plus technical data—are yours for the asking. Just fill in the coupon below. *Specialty Electronic Components Dept., General Electric Company, West Genesee Street, Auburn, New York.*

**Registered trademark of the General Electric Company.*

**Manager of Sales, Specialty Electronic Components Dept.,
General Electric Company, West Genesee St., Auburn, New York**

Please send me complete technical information on

RC Networks Lead Metaniobate
 Ferrites Wejcap Capacitors
 Thru-Con® Print Wire Boards

Name _____ Position _____

Company _____

Address _____

City _____ Zone _____ State _____

E1157

Progress Is Our Most Important Product

GENERAL  ELECTRIC

NEW!
1/4-WATT
 insulated
 hot molded
 composition
 resistor
only 1/4" long!

Cross section shows **molded insulating jacket**—the same construction as used for all A-B hot molded resistors.

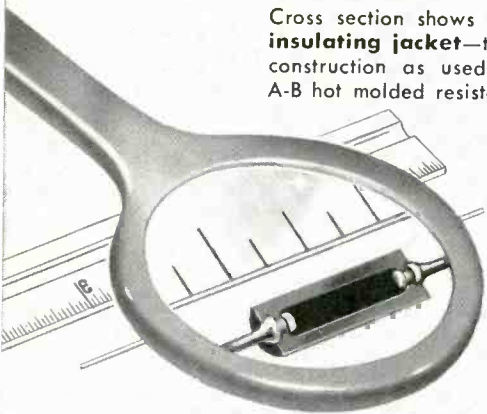

Here's a new 1/4-watt, *insulated* composition resistor in a truly *small* size . . . **ONLY ONE QUARTER OF AN INCH LONG** . . . that provides the same superlative performance, reliability, and uniformity which have made the Allen-Bradley hot molded resistor preferred the world over.

Although exceptionally small, Allen-Bradley Type CB hot molded resistors are rated for "continuous operation" at 70°C ambient temperatures. The hot molded construction of this Type CB resistor makes impregnation unnecessary . . . it also provides the most reliable protection against extended periods of high humidity, as encountered in practical applications. Available in all RETMA resistance values from 47 ohms to 22 megohms. Tolerances: 5%, 10%, and 20%.

Where space is at a premium . . . and where failures would be disastrous . . . you owe it to yourself to investigate this new addition to the Allen-Bradley quality line. Please write today for complete specifications. Samples available for your tests.

Allen-Bradley Co.
 1315 S. First St., Milwaukee 4, Wis.
 In Canada—Allen-Bradley Canada Ltd., Galt, Ont.



OTHER HOT MOLDED RESISTORS IN THE A-B FAMILY

Allen-Bradley fixed, molded resistors rated at 70°C ambient are available in standard RETMA values from 2.7 ohms to 22 megohms in 1/2 and 1-watt sizes . . . and from 10 ohms in the 2-watt size. In 5%, 10%, and 20% tolerances.



Allen-Bradley solid-molded resistors are packaged for either automatic or manual assembly. A-B carton packaging prevents bent or tangled leads. Pressure sensitive tape used to hold resistors in place on reels—for most economical assembly.

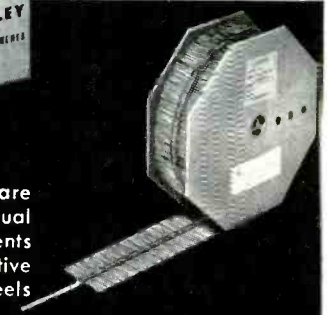

ALLEN-BRADLEY
HOT-MOLDED COMPOSITION RESISTORS



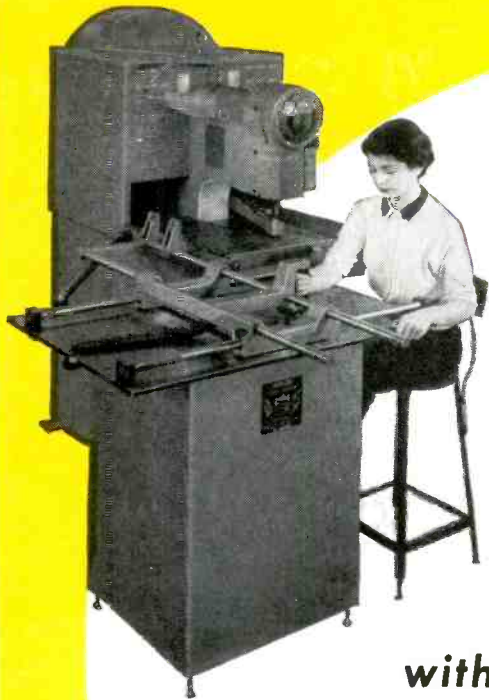

Punch PRINTED CIRCUITS Cold...

with WALES Fabricator-Duplicator

The WALES Fabricator combined with WALES positive Duplicator is the modern, low cost answer to printed circuit hole punching. You get holes with sharp definition, clean walls and minimum bell mouth. This equipment is perfect for short runs from one piece to thousands. Change dies for hole sizes in seconds with a range up to 3½" dia. Accuracy is automatic and positive. Make your own templates, too, on the Fabricator. No need for drilling machines or jig-borers. The WALES Fabricator-Duplicator is a complete punching shop in itself.

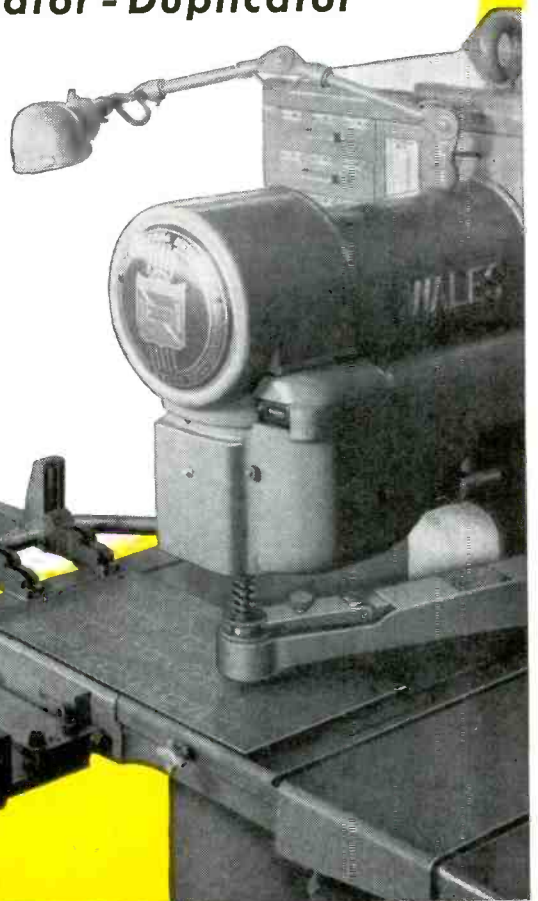

SEND FOR BULLETIN NO. 13K

Complete specifications and capacities are yours for the asking.

WALES Strippit COMPANY

A UNIT OF HOUDAILLE INDUSTRIES, INC.

AKRON, NEW YORK

WALES-STRIPPIT OF CALIF., SOUTH GATE, CALIF.
WALES-STRIPPIT OF CANADA LTD., HAMILTON, ONT.

"...the Wales-Way is the PLUS-PROFIT way"

PROOF THAT NEW SAVBIT ALLOY BY MULTICORE
MAKES COPPER SOLDERING TIPS
LAST UP TO 10 TIMES LONGER!

These photos illustrate the greatest solder



UNRETOUCHED PHOTOS: The three soldering iron tips illustrated above were taken from identical irons

Although this tip has been constantly rebuilt, it is now at the end of its useful life, having made only 7,500 soldered joints using a standard tin/lead alloy.

This tip has been used for making 1,000 soldered joints, using a standard tin/lead alloy.

This tip has been used for making more than 10,000 soldered joints with Ergin Multicore SAVBIT ALLOY. Note that it shows virtually no wear!

CONSIDER WHAT THIS CAN MEAN
TO YOUR MAINTENANCE
AND PRODUCTION COSTS!

advancement in 25 years

Now ready!

SAVBIT®

A SPECIAL ALLOY AVAILABLE ONLY IN ERSIN

Multicore
FIVE-CORE SOLDER



Simplified Explanation:

	Before Soldering	During Soldering	After Soldering
In soldering with straight tin/lead alloys...	Tin/Lead Solder Copper Tip Solder contacted by copper tip...	Molten Tin/Lead/Copper Copper Tip absorbs tip metal to saturation...	Tin/Lead/Copper Joint Copper Tip and wears out tip rapidly!
Whereas... In soldering with new SAVBIT ALLOY...	Tin/Lead/Copper Solder Copper Tip Copper-saturated SAVBIT solder...	Molten Tin/Lead/Copper Copper Tip cannot borrow copper from the iron...	Tin/Lead/Copper Joint Copper Tip which receives hardly any wear.

THIS EXPLAINS HOW SAVBIT ALLOY STOPS THE WEARING OUT OF COPPER TIPS

Two years ago, Multicore introduced a special alloy for soldering silver-plated ceramics, containing a 2% silver content, so that it would not absorb silver from the ceramic. The same patented principle has now been applied to prevent the copper of soldering iron tips being absorbed into solder alloys! Until now, incorporation of copper in a solder alloy to more than 0.3% of the tin content was discouraged, since it was believed that copper might slow the flow of solder in making seams. An extensive investigation under actual working conditions on television assembly lines has now proven that a copper-loaded alloy does *not* effect the speed of soldering, when making the joints which form 98% of the soldering processes in the assembly and manufacture of all electronic equipment.

WEAR OF COPPER TIPS

Most engineers have presumed that the wear of copper soldering iron tips used on

assembly lines was caused by (1) oxidation of the copper due to heat, (2) attack of the flux on the copper bit, and (3) absorption of the copper from the tip into the tin of the solder alloy. However, these investigations have proven conclusively that reasons (1) and (2) are not the explanation.

On the other hand, comparative tests between Ersin Multicore Solder with the new SAVBIT copper-loaded alloy, and solders containing pure tin/lead alloys have indicated that a reduction of about 9/10 in tip wear can be achieved by the use of SAVBIT ALLOY! It is a fact that the tip of an iron which needs resurfacing after 1,000 joints with normal tin/lead alloys can last for 10,000 or more similar joints before requiring resurfacing, using Ersin Multicore SAVBIT ALLOY. (See illustration.) Therefore, it is hardly necessary to emphasize the great economies that can be effected in soldering iron maintenance by using this new alloy. Equally important, a higher

standard of soldering is guaranteed throughout the life of the iron, because it stays in first class condition much longer!

CHARACTERISTICS AND SPECIFICATIONS

SAVBIT ALLOY is now available in Ersin Multicore 5-core solder, containing non-corrosive extra-fast Ersin Flux, in 14, 16 and 18 gauge.

MELTING POINT: Virtually the same as standard tin/lead alloys.

ELECTRICAL CONDUCTIVITY, TENSILE AND SHEAR STRENGTH: No appreciable difference between SAVBIT and normal tin/lead alloys. Strength of SAVBIT slightly greater.

IMPORTANT

SAVBIT is one of a number of alloys developed for the industry by Multicore. In addition to SAVBIT, Ersin Multicore, the world's finest cored solder, is also available in all the standard tin/lead alloys and diameters, in 1 lb. cartons and 7 lb. reels. Multicore contains 5 cores of exclusive, high speed, non-corrosive Ersin Flux. This great solder, so widely-imitated, has never been equalled for speed of operation, effective prevention of rejects and, in the long run, lowest cost for superior results.



SAVBIT ALLOY has been impressively proven on the assembly lines of England's greatest manufacturers. We will be pleased to furnish testimonials.

Address U. S. A. inquiries on company letterhead to Dept. MS167

MULTICORE SALES CORPORATION
PORT WASHINGTON, N. Y.

Canadian inquiries:
CHARLES W. POINTON LTD.
6 Alicia Ave., Toronto, Canada

Inquiries regarding other territories:
MULTICORE SOLDERS LTD.
Hemel Hempstead, Herts., England

PAN AMERICAN

WORLD'S MOST EXPERIENCED AIRLINE

SELECTS

EDO LORAN

Pan American World Airways has ordered Edo Loran units for installation in its fleet of Boeing and Douglas jet transports. Selection of the new Edo long-range navigation equipment followed testing in both Atlantic and Pacific service. Edo Loran drew praise from pilots and technical personnel alike for its simplicity of operation, accuracy and reliability. Edo's lightweight (29 pounds), compact design for cockpit installation, simple operation and directly-read data for pilot use, combined with the accuracy and proven reliability of the Loran system, were factors in Pan Am's choice of Edo Loran as the basic long-range navigation system for its upcoming fleet of jet aircraft.

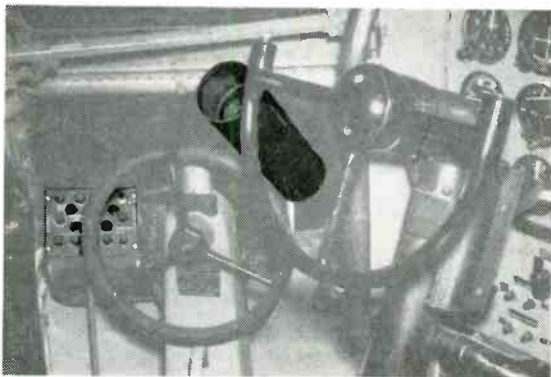

Installation of Edo Loran in Pan American Boeing Stratocruiser shows compact design and convenient mounting for pilot operation. $\frac{3}{4}$ ATR receiver unit is remotely installed.

Brochure available on request.



Corporation

College Point, Long Island, New York

a Trusted Line of Marine and Airborne Electronic Equipment



MICROWAVE SIGNAL GENERATION

**Complete Coverage
650 to 11,500 mc.**

Each Polarad Microwave Signal Generator is equipped with the unusually simple UNI-DIAL control that tracks reflector voltages automatically while tuning continuously. Frequency, accurate to $\pm 1\%$, is read directly on the single frequency dial. These rugged instruments include internal modulation, pulse and FM; internal square wave modulation, synchronization outputs, delayed and undelayed; provision for multi-pulse modulation input; provision for external modulation and synchronization; variable attenuator calibrated directly in dbm; engineered ventilation to insure specification performance over long operating periods.

SIGNAL GENERATORS

Model MSG-1
950-2,400 mc



Model MSG-2
2,150-4,600 mc



Model MSG-3
4,450-8,000 mc

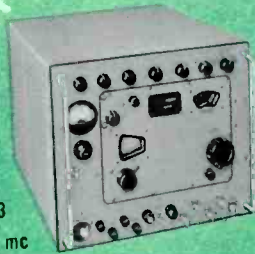

Model MSG-3A
4,200-11,000 mc



Model MSG-4A
6,950-11,500 mc

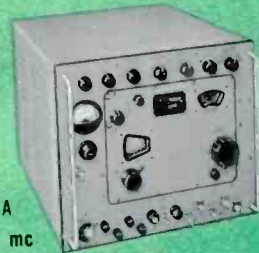

11,500 mc

650 mc



SIGNAL SOURCES

Model SSL
1,050-2,250 mc



Model SSS
2,140-4,600 mc



Model SSM-A
4,450-8,000 mc



Model SSX-A*
7,850-10,750 mc



These Polarad Microwave Signal Sources are direct reading and continuously tuned with Polarad's UNI-DIAL control that automatically tracks the reflector voltage as the klystron cavity is being tuned. Maximum power output is assured throughout the entire range of each instrument by means of a power set control. For improved stability, a klystron tube is in an external precision cavity. All Polarad Signal Sources can be externally modulated with either square wave or FM signals.

* (Model SSX-E 7,850-11,500 available on special order)

MICROWAVE SIGNAL GENERATION

Complete Coverage
12,400 to 50,000 mc

EHF Microwave Signal Generators

- A completely integrated self-contained signal generator covers 12,400 to 17,500.
- 7 plug-in r-f tuning units and a basic unit cover the frequency range from 18,000 to 39,700 mc.
- Direct-reading calibrated output attenuator, accuracy ± 2 db.
- Frequency calibration accomplished by a $\pm 0.1\%$ direct-reading wavemeter.
- Internal 1000 cps square-wave modulation.
- Capable of external modulation, both pulse and FM.
- Equipped with integral electronically-regulated power supplies.

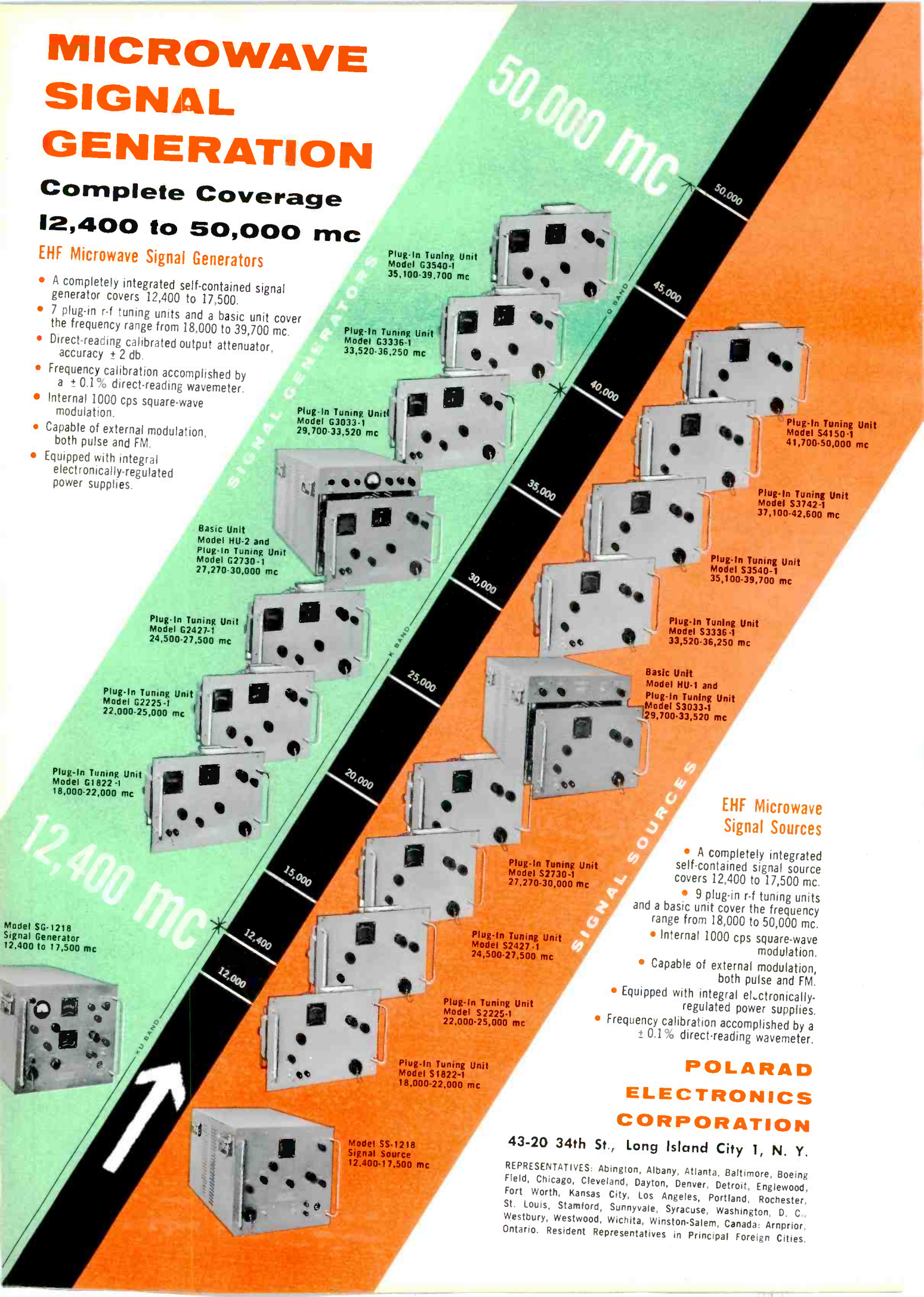

Model SG-1218
Signal Generator
12,400 to 17,500 mc



12,400 mc



Model SS-1218
Signal Source
12,400-17,500 mc

Plug-In Tuning Unit
Model G1822-1
18,000-22,000 mc



Plug-In Tuning Unit
Model G2225-1
22,000-25,000 mc

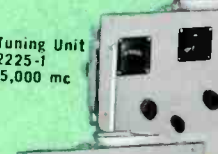

Plug-In Tuning Unit
Model G2427-1
24,500-27,500 mc

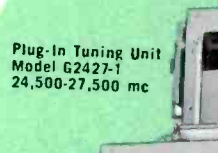

Basic Unit
Model HU-2 and
Plug-In Tuning Unit
Model G2730-1
27,270-30,000 mc



Plug-In Tuning Unit
Model G3033-1
29,700-33,520 mc



Plug-In Tuning Unit
Model G3336-1
33,520-36,250 mc

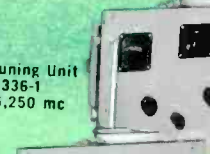

Plug-In Tuning Unit
Model G3540-1
35,100-39,700 mc



Plug-In Tuning Unit
Model S2730-1
27,270-30,000 mc



Plug-In Tuning Unit
Model S2427-1
24,500-27,500 mc



Plug-In Tuning Unit
Model S2225-1
22,000-25,000 mc



Plug-In Tuning Unit
Model S1822-1
18,000-22,000 mc



Basic Unit
Model HU-1 and
Plug-In Tuning Unit
Model S3033-1
29,700-33,520 mc



Plug-In Tuning Unit
Model S3336-1
33,520-36,250 mc



Plug-In Tuning Unit
Model S3540-1
35,100-39,700 mc



Plug-In Tuning Unit
Model S3742-1
37,100-42,600 mc



Plug-In Tuning Unit
Model S4150-1
41,700-50,000 mc

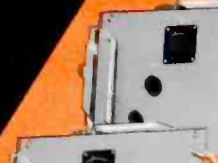

EHF Microwave Signal Sources

- A completely integrated self-contained signal source covers 12,400 to 17,500 mc.
- 9 plug-in r-f tuning units and a basic unit cover the frequency range from 18,000 to 50,000 mc.
- Internal 1000 cps square-wave modulation.
- Capable of external modulation, both pulse and FM.
- Equipped with integral electronically-regulated power supplies.
- Frequency calibration accomplished by a $\pm 0.1\%$ direct-reading wavemeter.

POLARAD ELECTRONICS CORPORATION

43-20 34th St., Long Island City 1, N. Y.

REPRESENTATIVES: Abington, Albany, Atlanta, Baltimore, Boeing Field, Chicago, Cleveland, Dayton, Denver, Detroit, Englewood, Fort Worth, Kansas City, Los Angeles, Portland, Rochester, St. Louis, Stamford, Sunnyvale, Syracuse, Washington, D. C., Westbury, Westwood, Wichita, Winston-Salem, Canada: Arnprior, Ontario. Resident Representatives in Principal Foreign Cities.

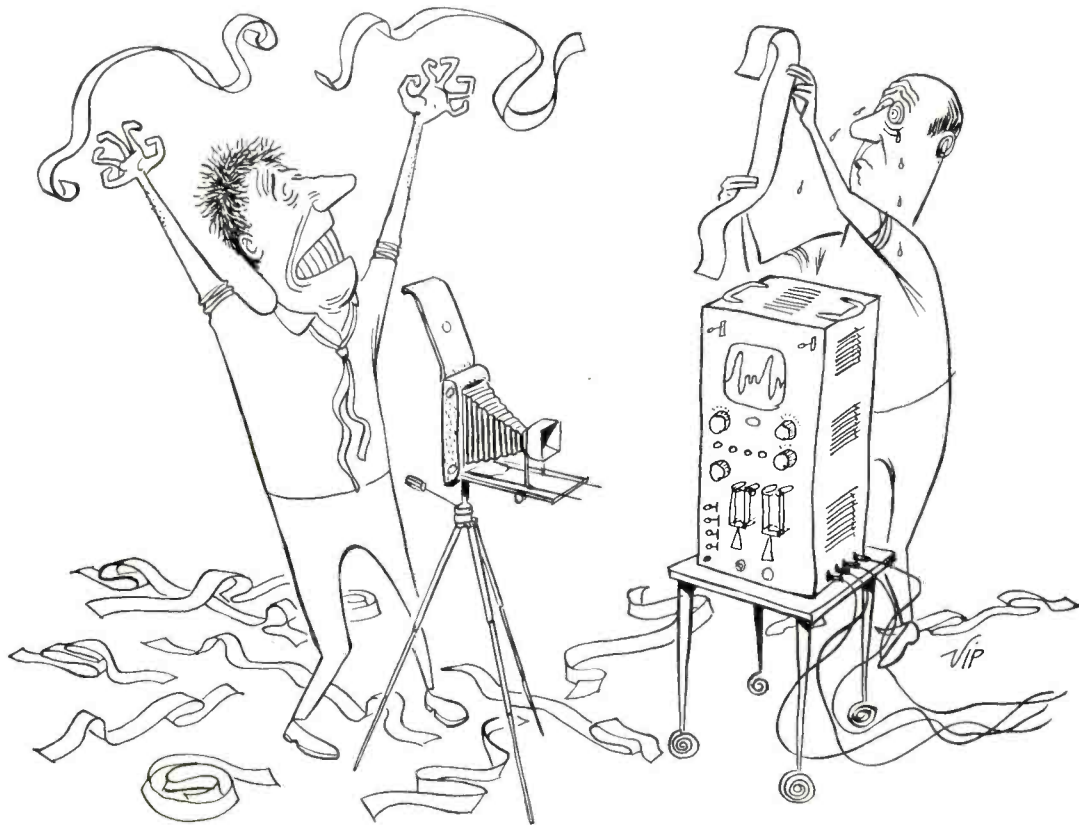

PROBLEM: Wave-form photography

Attempts at photographing elusive wave forms on conventional scopes have been, hitherto, a prodigious waste of time and film. Now, hair-trigger photography can be a thing of the past.

SOLUTION: a Hughes MEMO-SCOPE® Oscilloscope. What does the MEMO-SCOPE do that no other scope can? A storage-type oscilloscope, it can instantly "freeze" any number of selected traces until intentionally erased. Photos may thus be taken at leisure—with just one camera setting—one exposure—for each permanent record required. No tedious repetition. No more wasted film. The resultant savings can quickly pay for this "transient recorder with a memory."

If you haven't yet seen a demonstration of the MEMO-SCOPE Oscilloscope, ask a Hughes representative to arrange one. He'll quickly do so—at your convenience—in your area. Please send for Application Data Sheets Nos. MSAD-A1 and MSAD-A2. Write to:

HUGHES PRODUCTS

MEMO-SCOPE Oscilloscope

International Airport Station, Los Angeles 45, California

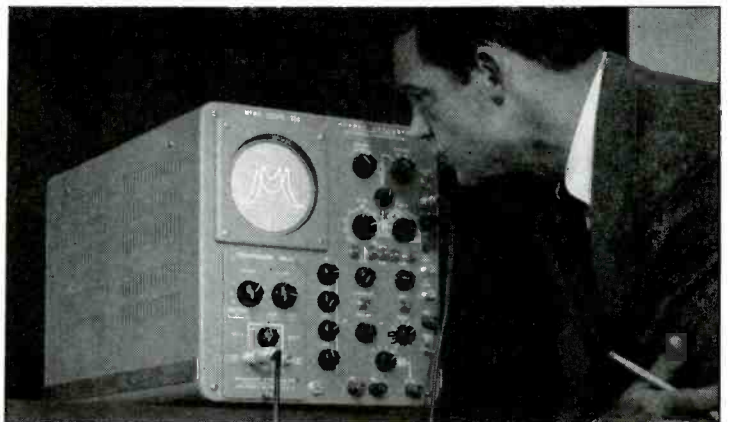

HUGHES MEMO-SCOPE OSCILLOSCOPE

STORAGE TUBE—5-inch diameter Memotron® Direct Display Cathode Ray Storage Tube. Writing speed for storage: 125,000 inches per second. The optional Speed Enhancement Feature multiplies writing speed approximately four times.

OSCILLOSCOPE—Controls: intensity, focus and astigmatism are provided for conventional adjustments. Flood gun, storage and erase permit regulation of the storage performance.

PREAMPLIFIER TYPE WB/4—Standard equipment with the described instrument. Frequency response: Vertical, DC to 250 KC down 3 db at 250 KC. Sensitivity: 10 millivolts to 50 volts per division (0.33") in 9 calibrated steps. Or, it is adjustable continuously with a 10:1 vernier.

Creating a new world with ELECTRONICS

HUGHES PRODUCTS

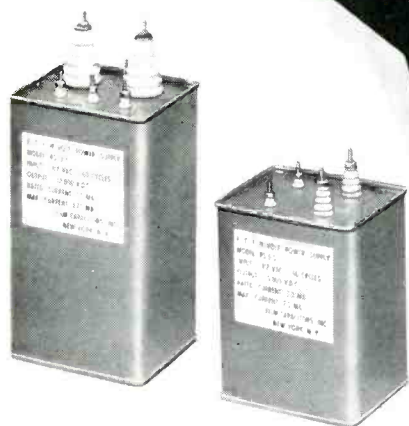

Hermetically-sealed Self-contained **POWER SUPPLIES**

by

fci

Designed for

HIGH VOLTAGE

Low Current DC Applications

- Oil filled construction and special miniaturized components make for a compact, light weight, reliable unit.
- All models are designed with a full wave doubler circuit.
- Safety-rated components assure long trouble-free life.
- Neutral case may be positive, negative, or left floating.
- Specially constructed F.C.I. plastic dielectric capacitors assure low ripple, compactness, and reliability.
- Housed in CP70 cases, which makes for easy mounting and attractive appearance.
- Solder sealed terminals are used exclusively to prevent oil leakage.
- Voltages on all models can be varied from zero to maximum.
- Designed to operate at temperatures up to 65C.
- The 2 and 5 KV units utilize selenium rectifiers; the 12 and 15 KV units utilize ruggedized 1B3 tubes.
- Voltages of 30 and 50 KV are available upon request, as well as 400 cycle supplies in all voltages.

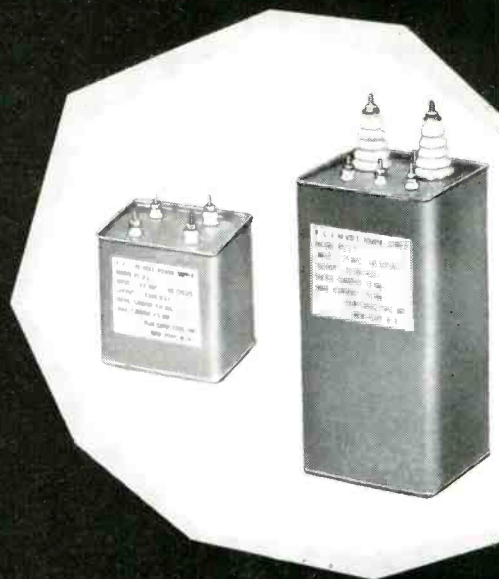

ELECTRICAL CHARACTERISTICS

PART NO.	OUTPUT VOLTAGE	% RIPPLE AT RATED CURRENT	RATED CURRENT OUTPUT	MAX. CURRENT OUTPUT
PS - 2 S	2 KVDC	1%	5 MA	7.5 MA
PS - 5 S	5 KVDC	1%	5 MA	7.5 MA
PS - 12 T	12 KVDC	1.5%	1 MA	1.75 MA
PS - 15 T	15 KVDC	1.5%	1 MA	1.75 MA

For Varied Applications

1. Radiation counters
2. Spectrographic analyzers
3. Dust and electrostatic precipitators
4. Oscilloscopes
5. Display tubes
6. Projection television sets
7. Many types of air-borne equipment
8. Fire control equipment
9. Xerographic process printers
10. Cable and Insulation Testers

fci

film capacitors, inc.

3400 PARK AVENUE, NEW YORK 56

CYpress 2-5180



In the field of RECONNAISSANCE **LORAL**
has developed *Important New Concepts* in:

- ASW and AEW DISPLAY SYSTEMS
- AIRBORNE NAVIGATIONAL COMPUTERS
- MILITARY PLOTTERS
- ELECTRONIC COUNTERMEASURES
- GUIDANCE SYSTEMS

and has competently served the ARMED FORCES directly, and their PRIME CONTRACTORS.



LORAL ELECTRONICS CORPORATION
NEW YORK 72, NEW YORK

A Dip here does so much

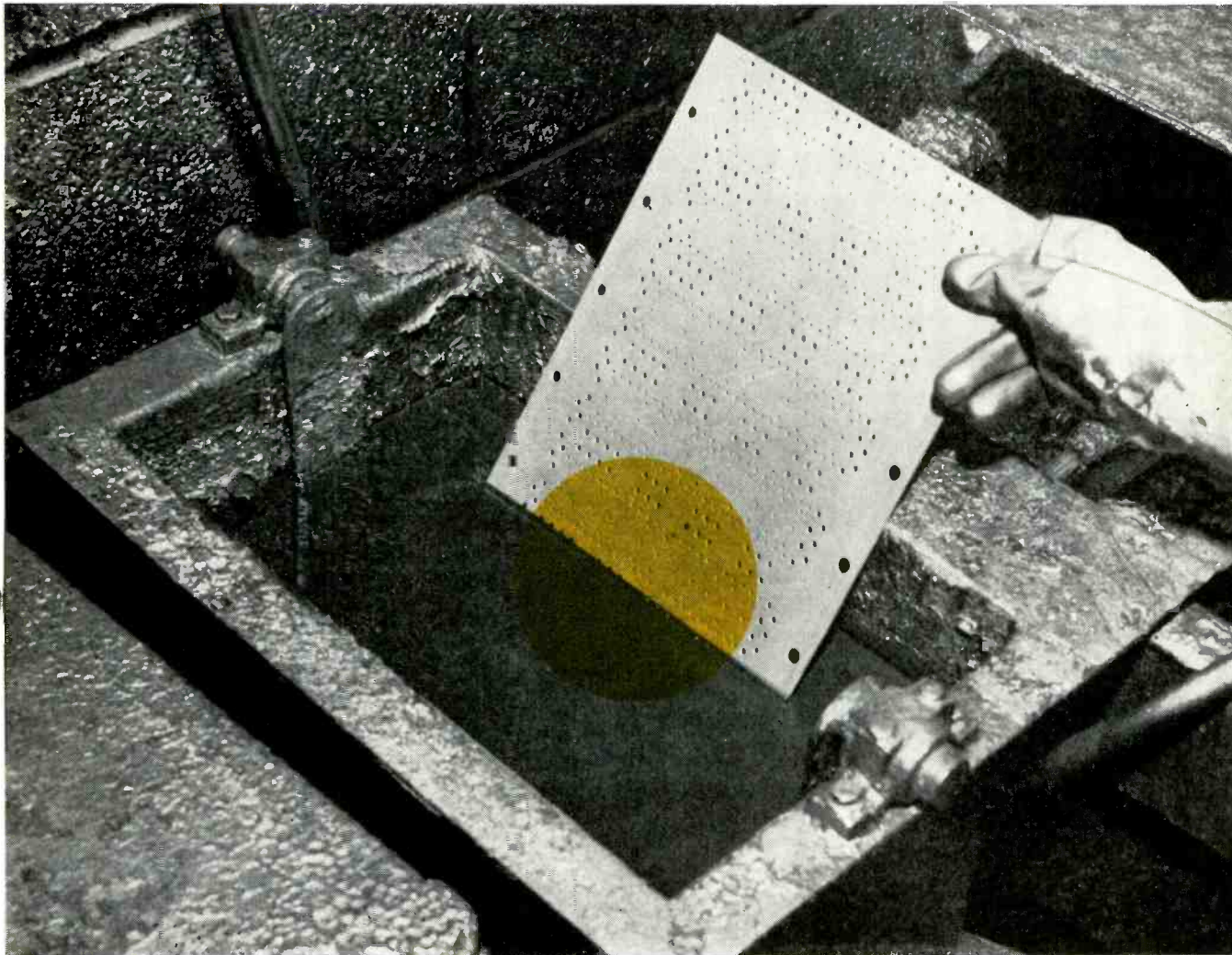

Photo courtesy International Business Machines Corp.

How 'dag'[®] can spell the difference between possible and impossible!

Take the case of International Business Machines Corporation, for example. At the company's Kingston, New York plant, a dip in a 'dag' dispersion makes it possible to plate a conductor through holes in copper clad phenolic sheets.

Used in the production of printed circuit cards, the pierced sheets are dipped in a solution of 'dag' dispersion #154 and alcohol. The sheets then pass through rubber rollers which remove excess solution from the surface and are then conveyed through an oven to dry. Following this, an automatic sanding machine removes excess graphite

from the surface, leaving a graphite coating on the walls of the holes in the sheet.

Conductors are then plated through these holes in production of printed circuit cards for the IBM SAGE Computer produced for the U. S. Air Force.

This is only one of many practical benefits of 'dag' colloidal graphite dispersions. An Acheson Service Engineer will be glad to consult with you on any problem you may have, where a graphite coating can help you. Bulletin 433 will provide additional valuable information; for your copy, address Dept. E-11.

ACHESON COLLOIDS COMPANY

Port Huron, Michigan... also Acheson Colloids Ltd., London, England

ACHESON COLLOIDAL DISPERSIONS:

Graphite · Molybdenum Disulfide · Zinc Oxide · Mica and other solids

Offices in: Boston · Chicago · Cleveland · Dayton · Detroit · Los Angeles

Milwaukee · Philadelphia · New York · Pittsburgh · Rochester · St. Louis · Toronto



Boost DC power efficiency, cut costs with Westinghouse Silicon Rectifiers!

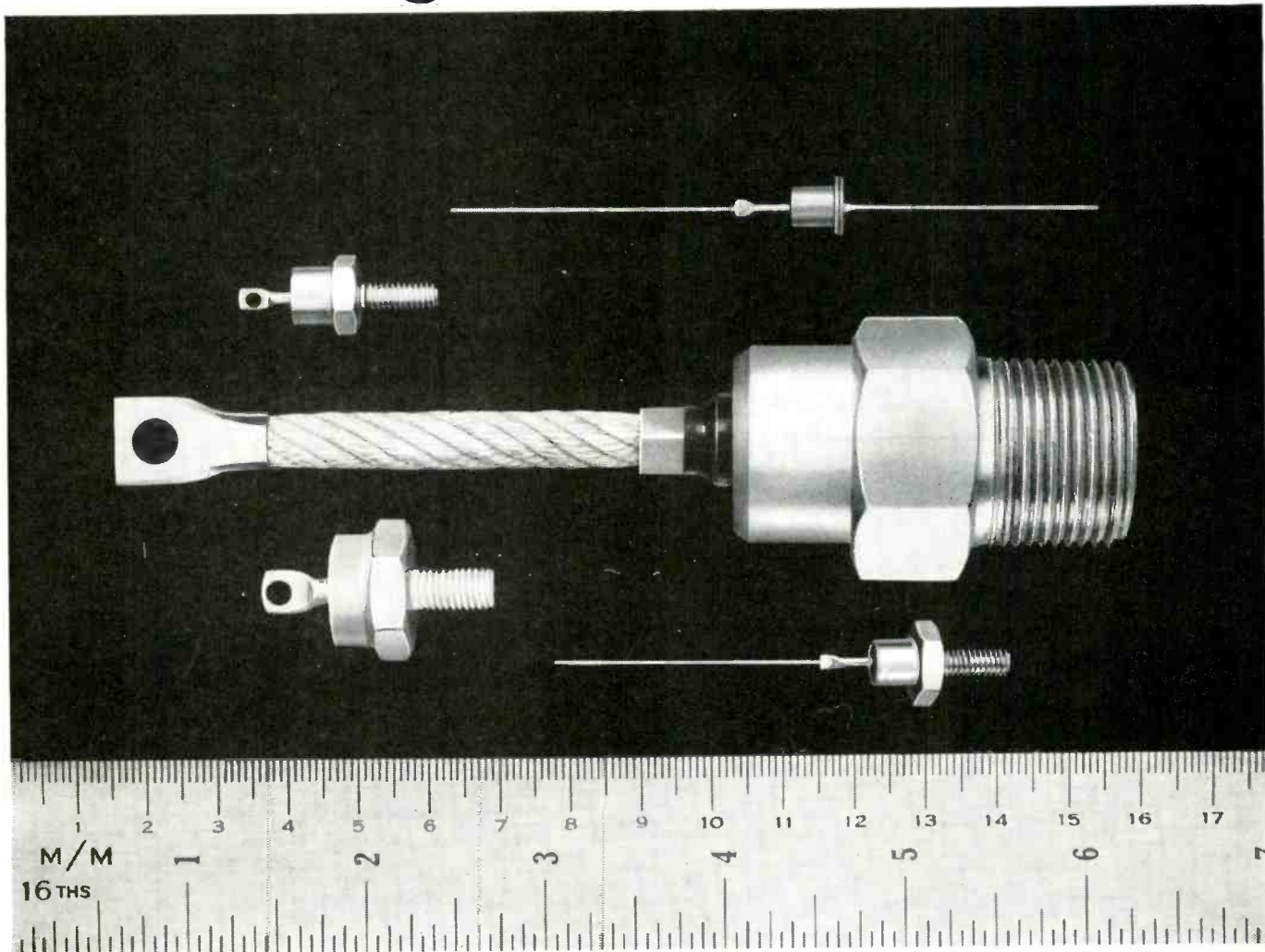

Whether you *use* or *manufacture* DC power equipment for low or high-power applications, Westinghouse Silicon Rectifiers offer you a way to step up power output efficiency yet save space, weight—and costs!

Manufacturing economies through tremendous volume and engineering know-how permit Westinghouse to bring you a product that is unsurpassed for quality at the lowest prices in the industry. All Westinghouse Silicon Rectifiers meet Military Environmental Tests and are ruggedly designed to withstand a wide range of operating conditions.

Westinghouse Silicon Rectifiers are ready for immediate delivery. Why not find out how they can cut DC power costs for you? Call your local Westinghouse Representative or mail the coupon now.

YOU CAN BE SURE... IF IT'S
Westinghouse

WESTINGHOUSE SILICON RECTIFIERS				
HIGH & MEDIUM POWER				
Number	PIV (Max.)	Peak Reverse Current (Max.)	Maximum Current at 150°C Case	Thermal Drop Junction to Case
302	50-600 V	20 Ma	35 Amps.	1°C Per Watt
303	50-600 V	10 Ma	18 Amps.	1.5°C Per Watt
304	50-600 V	10 Ma	12 Amps.	2°C Per Watt
322	50-500 V	40 Ma	110 Amps.	.3°C Per Watt
LOW POWER				
305	50-800 V	1.5 Ma	1.6 Amps.	5°C Per Watt
320	50-800 V	1.5 Ma	1.6 Amps.	5°C Per Watt

Mail Coupon Now

Westinghouse Electric Corp.
P. O. Box 868
Pittsburgh 30, Penna.

Will you please send me full information on Westinghouse Silicon Rectifiers No.(s) _____

NAME _____

TITLE _____

COMPANY _____

ADDRESS _____

Lavoie

From the broad experience
of our years — from a
great aggregation of
Oscilloscope skills —

This Important Engineering Achievement **NEW MODEL** **OSCILLOSCOPE** **LA-259D**

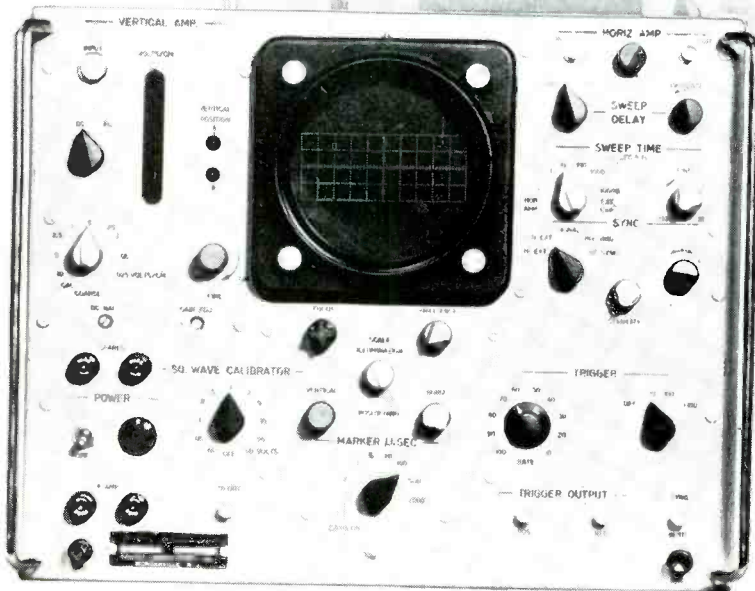

WITH FIVE INCH CR TUBE

Here's down-to-earth practicality in a scope of functional simplicity, dependable performance and highest accuracy. Embodying refinements of all the best features of the Lavoie LA-239C (USM-50)—workhorse and standard of accuracy for the military and missiles systems—the LA-259D provides greater CRT viewing area with brighter images for pulses of high speed. Amplitude measuring is speeded up by a direct reading amplitude scale. The highly visible scale changes with each range . . . prevents confusion, eliminates multiplication errors. Completely ruggedized for field use as portable bench unit, or installed in relay rack, the Lavoie LA-259D Oscilloscope meets all military requirements. Send for brochure and complete specifications.

SPECIFICATIONS

VERTICAL AMPLIFIER

- Deflection Sensitivity: 10 mv/cm ac or dc
- Transient Response: better than 0.02 microseconds
- Frequency Response: dc to 15 mc, 2 cps to 15 mc, ac Sensitivity approx. 50 mv/cm at 25 mcs.
- Compensated Attenuator: calibrated from 0.01 v/cm to 25 v/cm
Calibration continuous with vernier cursor.
Direct reading indication.
- Signal Delay: 0.2 usec delay network

TIME BASE

- Sweep Range: 0.07 usec/cm to 0.1 sec/cm in 6 steps.
Facilities for external capacitor.
- Sweep Expansion: 10 times
- Triggering: internal trigger generator, external, signal and high frequency sync.
- Horizontal Amplifier; frequency response 10 cycles to 750 kc. Can be used as external amplifier—source of sawtooth voltage.

OTHER CHARACTERISTICS

- Square Wave Voltage Calibrator: Internally generated 1 kc square wave—0.01 v to 50 v in 11 steps.
- Z Axis Timing Markers: available at 0.2, 1, 5, 20, 100, 500 and 2000 usec intervals synchronized with sweep.
- Flat Face CRT: Dumont K1443 P2 (P1, P7, P11 optional)
- Accelerating Potential: 10,000 volts
- Electronically-Regulated Power Supplies
- Power: 115/230 v—50 to 1000cps, 325 watts.

Lavoie Laboratories, Inc.

MATAWAN 1, NEW JERSEY

ALBANY, J. A. Reagan Co., Albany 8-5155 · BALTIMORE, Thomas L. Taylor, Belmont 5-9126 · BOEING FIELD, Testco, Mohawk 4895 · CHICAGO, R. Edward Stemm, Estebrook 9-2700 · DENVER, Allen I. Williams Co., Main 3-0343 · EUCLID, O., Electro Sales Associates, Redwood 2-7444 · FORT WORTH, Mitchell Spears Co., WA 6-4444 · HARTFORD, Michael S. Caldwell, Jackson 2-5832 · LOS ANGELES, Kittleson Co., Webster 3-7371 · SAN CARLOS, Cal., R. L. Pflieger Co., Lytell 1-0396 · ST. LOUIS, Edwin L. Murty, Jefferson 1-2075 · WEST ORANGE, N. J., Louis A. Garten & Associates, Redwood 1-1800 · CANADA, Instronics Limited, Stittsville, Ont. EXPORT, Frazer & Hansen, Ltd., New York City.

**“top
hat
design”**

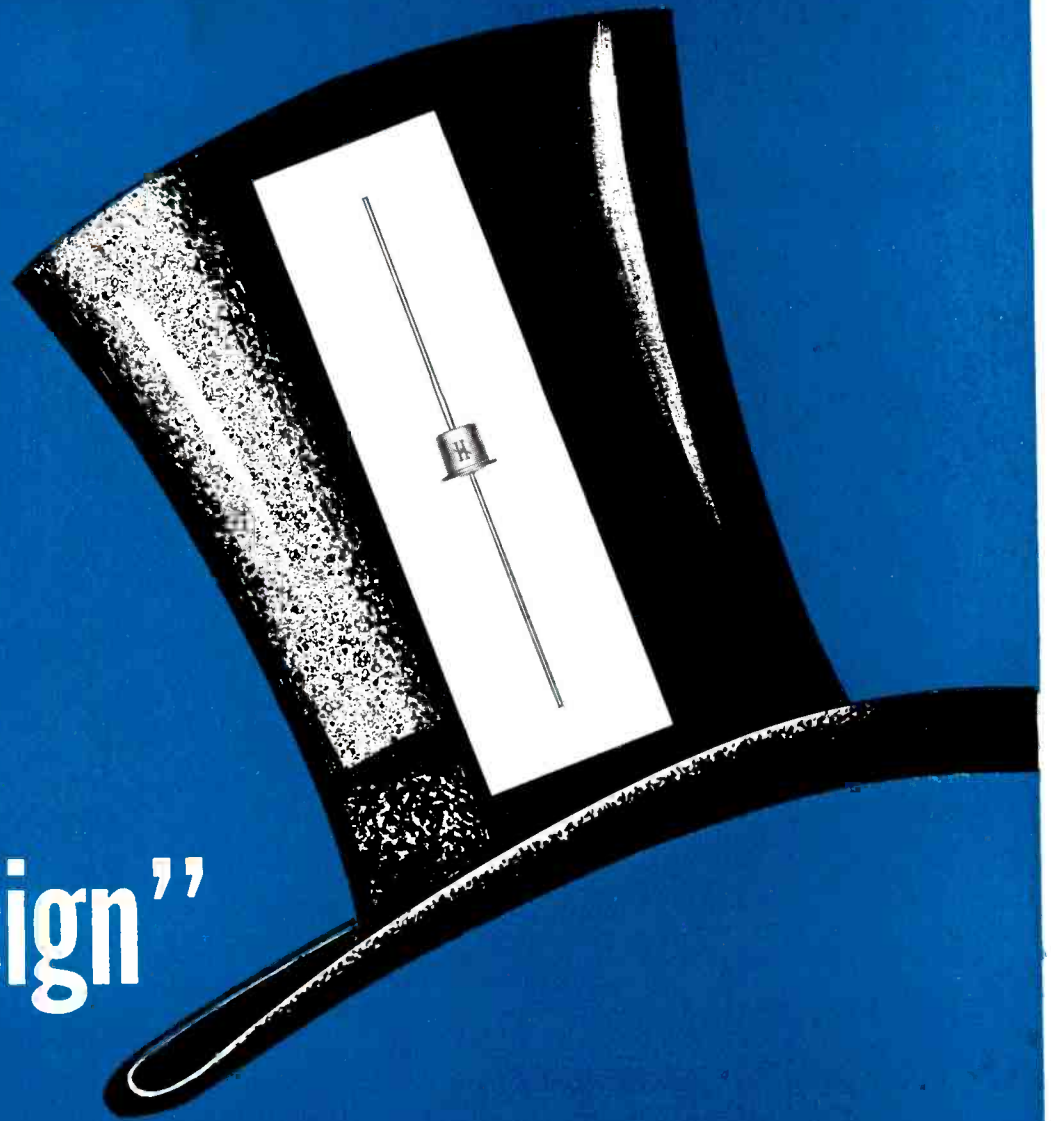

**for Air-borne Power Supplies
and Other Military and Industrial Applications**

These Hoffman Silicon Medium Power Rectifiers are available in the following RETMA types: IN536, IN537, IN538, IN539, IN540, IN1095. Current ratings up to 250ma at 150°C ambient; peak reverse working voltage up to 500. Diffused junction offers long life and high efficiency.

Write for complete information today.



Hoffman Semiconductor Division

HOFFMAN ELECTRONICS CORPORATION 930 Pittier Avenue, Evanston, Illinois

Canadian Offices: Montreal and Toronto • Export Offices: New York City

MANUFACTURERS OF: silicon junction diodes • zener voltage elements • medium and high power rectifiers • thin film solar cells

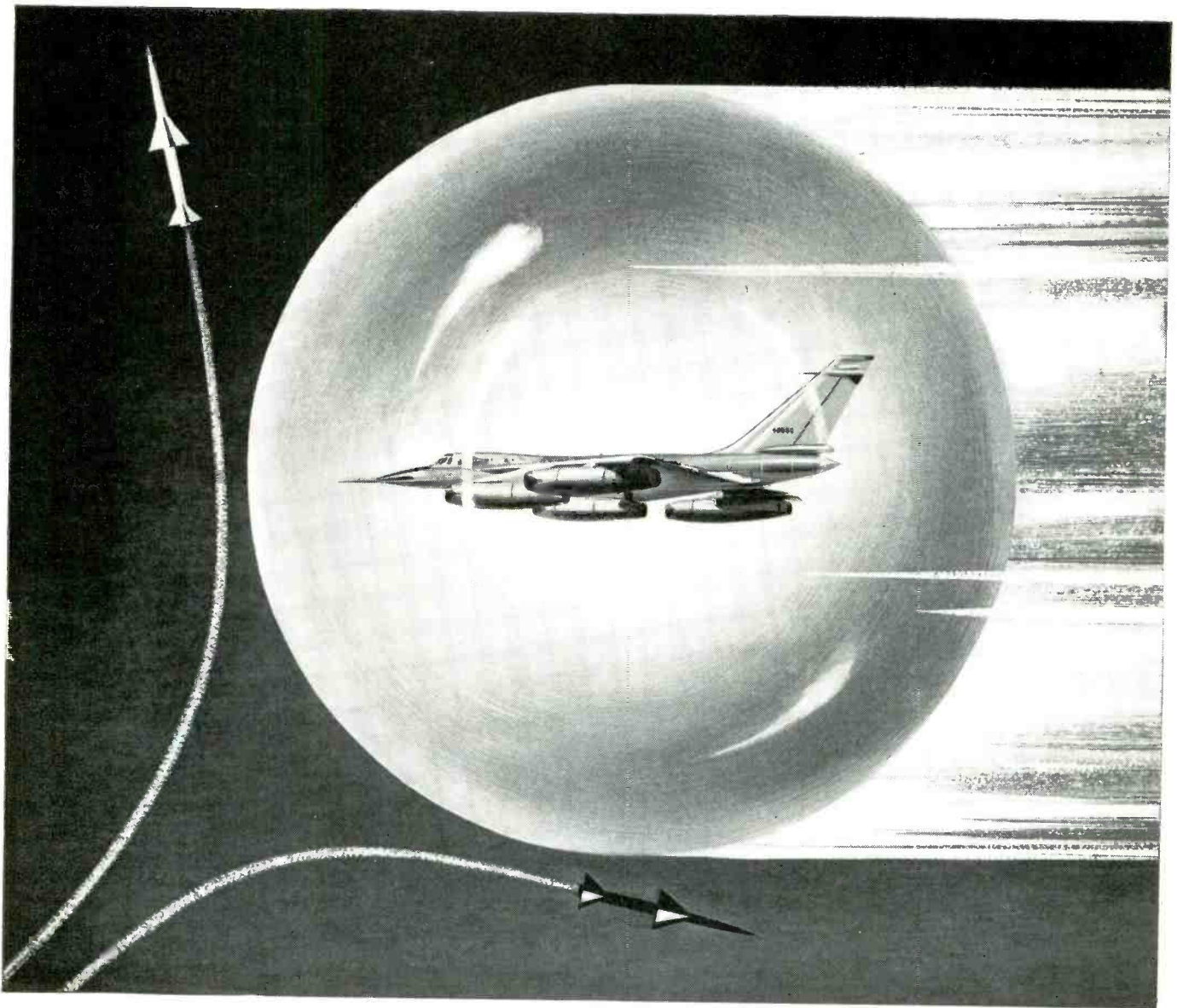

The Convair B-58 Hustler, first U. S. Air Force supersonic bomber, will be protected by Sylvania's electronic countermeasure equipment.

The invisible shield

Now, AN INVISIBLE electromagnetic shield will protect our United States Air Force's first supersonic bomber against electronically guided weapons.

The heart of this silent protector is a lightweight electronic countermeasure system, developed and produced by Sylvania's Electronic Systems Division. This system stands ready to baffle enemy radar seeking to guide missiles against the new aircraft.

In designing and developing the B-58's passive defense system, Sylvania made important advances in special components, including new cooling, packaging and miniaturization techniques.

Staffed with top-ranking scientists and engineers, backed by extensive research facilities and modern automated mass production capabilities—the Sylvania Electronic Systems Division is a major contributor to our national arsenal for defense. In-

tensive specialization in the Weapons System concept has resulted in utmost organizational efficiency, as well as the highest order of management competence.

Whether your project requires management or technical experience for complex integrated systems, subsystems, equipments or special components, from initial concept through mass production—Sylvania engineers will be glad to discuss methods of solving your specific problems.

SYLVANIA ELECTRIC PRODUCTS INC.
Electronic Systems Division
100 First Avenue, Waltham, Mass.



SYLVANIA

LIGHTING • RADIO • ELECTRONICS • TELEVISION • ATOMIC ENERGY

Constantin GLASS-TO-METAL SEALS

TRANSFORMERS



RECTIFIERS



CAPACITORS



RELAYS



TRANSISTORS

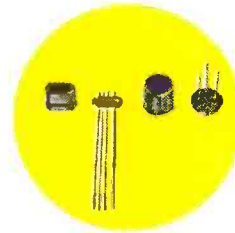

CRYSTALS

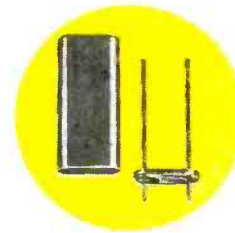

Quality

COMPONENTS

DEMAND QUALITY SEALS

Whether you're a designer of transformers, relays, capacitors, rectifiers, diodes, crystals, or any component that needs glass-to-metal sealing . . . insure positive end performance with Constantin Glass-To-Metal Seals.

At Constantin quality comes first. Each and every glass-to-metal seal is manufactured to the closest engineering tolerances . . . and six separate production line checkpoints maintain these tolerances thru final assembly.

Constantin's precision production is versatile . . . a most complete line of both standard and custom-designed all-in-one assemblies, end seals, transistor mounts, crystal covers, connectors, and unit headers is maintained to fulfill your most exacting demands.

Engineering is of prime importance at Constantin, too . . . over many years Constantin has built up an outstanding reputation for working with designers and delivering many unique and unusual designs.

These many-sided Constantin services can be yours for the asking.

Write for complete design information . . . today!

"Quality With Confidence"



L. L. Constantin & Co.

**MANUFACTURING
ENGINEERS**

Route 46, Lodi, N. J. • 187 Sargeant Ave., Clifton, N. J.

Everything
you need!



fast, easy

SPECIFICATIONS

130A

Input Amplifiers: (Similar Vert. and Horiz. Amps.). Sensitivity 1 mv/cm to 50 v/cm; 14 calibrated ranges, 1-2-5-10 sequence plus continuous vernier. Pass band dc to 300 KC; ac or dc coupling. Balanced input on 1, 2, 5, 10 and 20 mv/cm ranges.

Sweep Range: 1 μ sec/cm to 12 sec/cm. 21 sweeps: 1-2-5-10 sequence, 5% accuracy.

Triggering: Internal, line voltage or external 0.5 v or more. Pos. or neg. slope, +30 to -30 v trigger range.

Preset Trigger: Optimum setting for automatic stable triggering.

Amplitude Calibration: 1 KC square wave, 5% accuracy.

Price: \$650.00.

SPECIFICATIONS

150A, 150AR

Sweep Range: 0.02 μ sec/cm to 15 sec/cm.

Calibration: 24 sweeps: 1-2-5-10 sequence, 0.1 μ sec/cm to 5 sec/cm. 3% accuracy.

Triggering: Internal, line voltage or external 0.5 v or more. Pos. or neg. slope, +30 to -30 v trigger range.

Preset Trigger: Optimum setting for automatic stable triggering.

Horizontal Amplifier: Sweep magnification 5, 10, 50, 100 times. Vernier position control selects any 10 cm part of sweep. External input pass band dc to over 500 KC. Sensitivity 200 mv/cm to 15 v/cm.

Vertical Amplifier: Pass band dc to 10 MC. Optimum transient response and rise time less than 0.035 μ sec. Signal delay of 0.25 μ sec permits leading edge of triggering signal to be viewed.

Amplitude Calibration: 18 calib. voltages, 1-2-5-10 sequence, 0.2 mv to 100 v peak-to-peak. Accuracy 3%. Approx. 1 KC square wave, rise and decay approx. 1.0 μ sec.

Prices: -hp- 150A High Frequency Oscilloscope, \$1,100.00.

-hp- 150AR Rack Mount Oscilloscope, \$1,200.

-hp- 151A High Gain Amplifier, \$200.00.

-hp- 152A Dual Channel Amplifier, \$250.00.

HEWLETT-PACKARD COMPANY

4407A Page Mill Road • Palo Alto, Calif., U.S.A.

CABLE "HEWPACK" • DAVENPORT 5-4451

Field engineers in all principal areas

Data subject to change without notice.

Prices f.o.b. factory.

- Immediate delivery. See your -hp- rep now!
- Direct reading, extreme accuracy
- Color-coded controls; simplest to use
- Highest performance, highest quality
- Universal automatic triggering



Low Frequency Cabinet Oscilloscope, Model 130A. Covers dc to 300 KC. Similar horizontal and vertical amplifiers. Input circuits balanced on 5 most sensitive ranges. Single ended input may be dc or ac coupled. Direct reading, linear sweep times. With most transducers, needs no preamplification to produce brilliant, high resolution trace. Universal automatic triggering; one preset condition provides optimum triggering for almost all inputs. \$650.00.

Low Frequency Rack Mount Oscilloscope, Model 130BR. Similar to -hp- 130A except for rack mount and includes x5 magnifier usable on all ranges and expanding fastest sweep to 0.2 μ sec/cm. Parallel input terminals front and rear. \$650.00.

to use, quality

OSCILLOSCOPES



High Frequency Cabinet Oscilloscope, Model 150A. Covers dc to 10 MC with new reliability and convenience. Two plug-in preamplifiers for high gain or dual channel measurement (see below). 24 direct-reading sweep times; sweeps 0.02 μ sec/cm to 15 sec/cm. Universal automatic triggering; one preset condition insures optimum triggering. \$1,100.00.

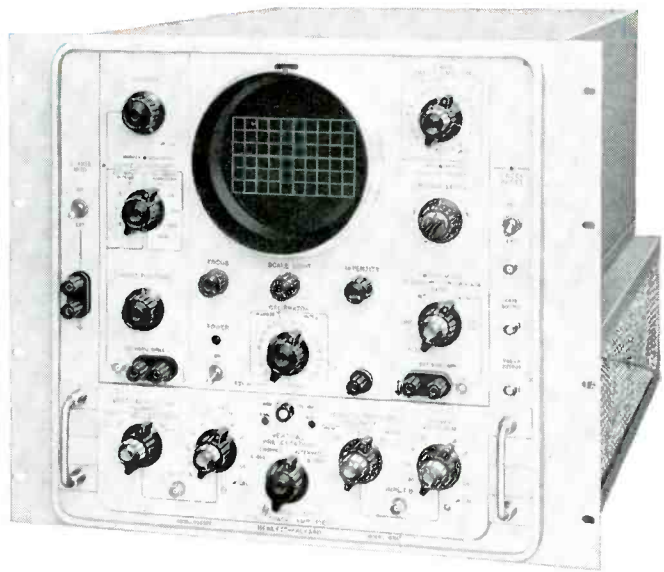

High Frequency Rack Mount Oscilloscope, Model 150AR. Same as -hp- 150A except for mounting in standard relay rack. Fitted with "pull-out" slides for maximum servicing accessibility. \$1,200.00.

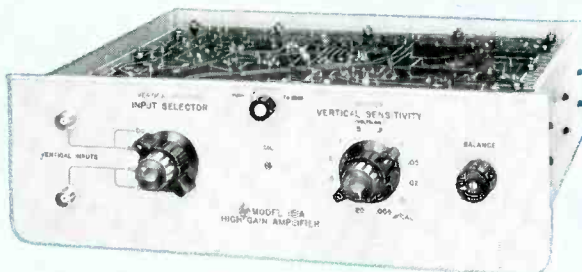

High Gain Amplifier, Model 151A. Designed for plug-in use with -hp- 150A or 150AR Oscilloscopes. High gain unit with 5.0 mv per cm sensitivity and frequency response dc to 10 MC. 12 calibrated ranges in 0.5, 1, 2, 5 sequence. 1 megohm input impedance with 25 μ mf shunt. Pass band rise time 0.035 μ sec. Equipped with two BNC input terminals. \$200.00.

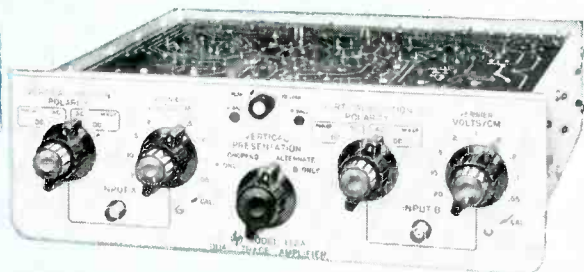

Dual Channel Amplifier, Model 152A. Designed for plug-in use with -hp- 150A or 150AR Oscilloscopes. Permits two phenomena to be presented on CRT simultaneously. Either amplifier usable separately. For dual presentation, electronic switch applies outputs to alternate traces, or switches outputs at a 100 KC rate. 50 mv/cm sensitivity, 9 ranges, 1, 2, 5, 10 sequence. \$250.00.

MINNIE

MINIATURE CONNECTORS

... the only miniature connector line fully conforming to the "E" REQUIREMENTS OF MIL-C-5015C.

Meet minnie—a complete line of miniature connectors with outstanding reliability features! The first miniatures to meet fully the "E" performance requirements of MIL-C-5015C, minnie's are environmentally sealed to resist moisture and humidity; ruggedly built to resist shock and vibration; imaginatively designed to provide application versatility.

FEATURES

1. Environmentally sealed with unitized back end grommet. (Also available with provision for potting.) Either grommet seal or potted seal meets moisture resistance requirement of MIL-C-5015C, Paragraph 4.5.21.
2. Spring-loaded coupling ring provides a positive locking action in the bayonet slot, and a constant compensating force which eliminates the effects of resilient face seal compression set.
3. Stainless steel bayonet slots and pins reduce wear and frictional characteristics. The three pin bayonet coupling minimizes the rocking action of the mated plug and receptacle.
4. Flattened incline angle of bayonet slots reduces mating force requirement.
5. Hooded contacts resist test prod damage as defined in Paragraph 4.5.14 of Amphenol Specification 340-43-2108.
6. Unitized grommet seal; clamp and grommet form a single unit for ease of assembly and maintenance.
7. Face seal gasket with individual barriers to isolate each contact.
8. Hard insert dielectric (plus resilient face seal) positively retains contacts with no possibility of contacts being pushed out of the insert.
9. A visual full engagement indicator is included in the design to insure the user that he has fully engaged the connectors. The indicator is an orange line around the receptacle shell.
- When using mated sealed connectors, no derating for altitude is necessary at 70,000 feet.
- Test voltage 1,500 volts RMS 70,000 feet on sealed connectors.
- Vibration per Method 204 of MIL-Std-202A. 10 to 2,000 cps at 20 g's.
- Temperature cycling range per MIL-C-5015C, Paragraph 4.5.3 increased to 257°F. maximum and -67°F. minimum.

send COUPON for Complete Catalog

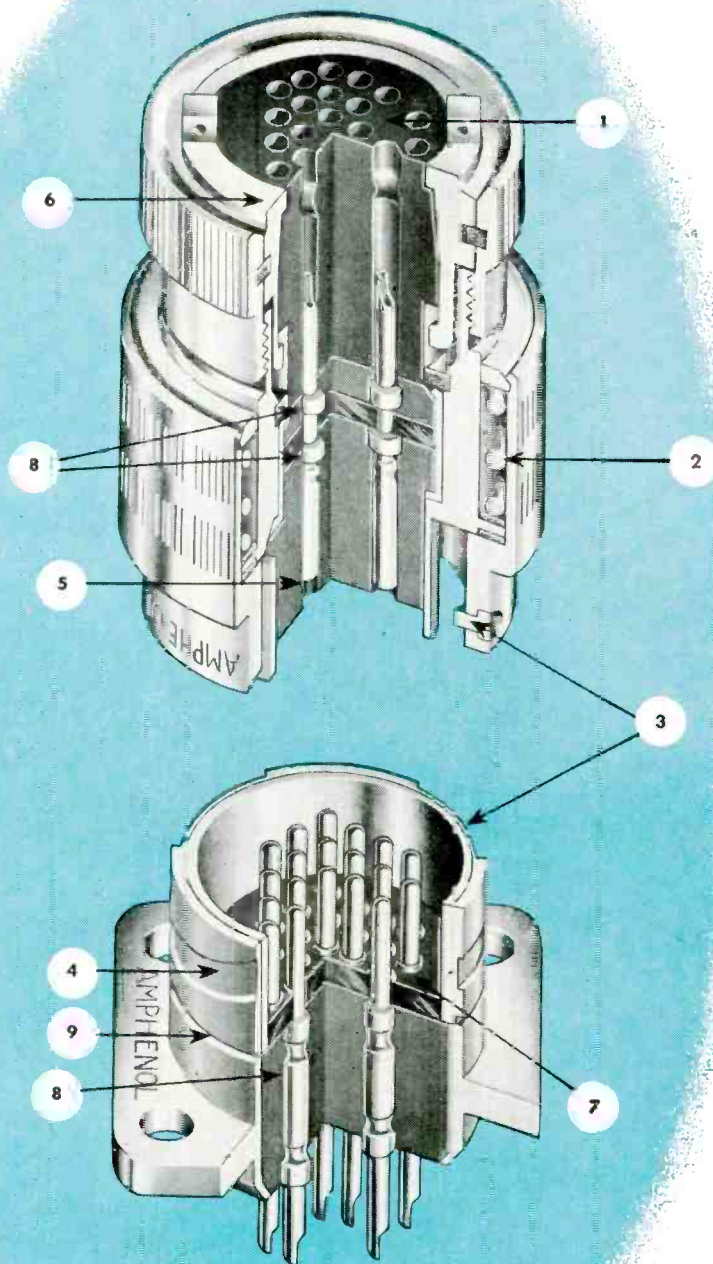

AMPHENOL ELECTRONICS CORPORATION 1830 S. 54th Ave., Chicago 50, Illinois

Please send me a copy of MINNIE catalog.

NAME _____

TITLE _____

COMPANY _____

NUMBER & STREET _____

CITY, ZONE & STATE _____

AVAILABILITY:

4 CONSTRUCTIONS: "E", Potting, Jacketed Cable, Cable Clamp
 5 SHELL SIZES: 12, 14, 18, 20, 22
 17 INSERT ARRANGEMENTS: Up to 48 contacts; coax and hermetic seals also

NEW POWERSTAT® Variable Transformer

TYPE LW136

New Flexibility with Isolated Secondary Winding on Single Core

... a source of adjustable low voltage output
... a limited range line correction
... a limited range of "buck boost" voltage



TYPE LW136



TYPE LW136-3

SINGLE PHASE

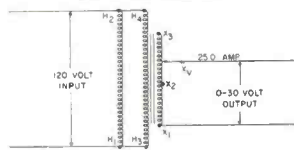

INPUT 120 Volt, 50/60 Cycle, 1 Phase
OUTPUT 0-30 Volt, 25 Amp., 0.75 KVA

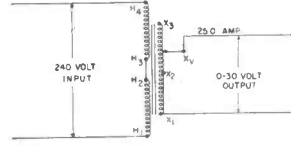

INPUT 240 Volt, 50/60 Cycle, 1 Phase
OUTPUT 0-30 Volt, 25 Amp., 0.75 KVA

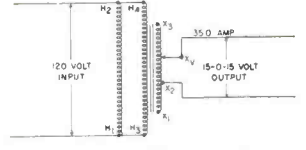

INPUT 120 Volt, 50/60 Cycle, 1 Phase
OUTPUT 15-0-15 Volt, 35 Amp., 0.53 KVA

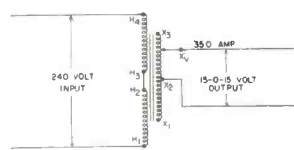

INPUT 240 Volt, 50/60 Cycle, 1 Phase
OUTPUT 15-0-15 Volt, 35 Amp., 0.53 KVA

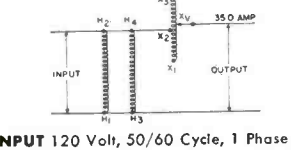

INPUT 120 Volt, 50/60 Cycle, 1 Phase
OUTPUT 105-135 Volt, 35 Amp., 4.7 KVA

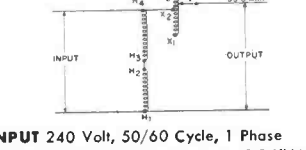

INPUT 240 Volt, 50/60 Cycle, 1 Phase
OUTPUT 225-255 Volt, 35 Amp., 8.9 KVA

INPUT 107-137 Volt, 50/60 Cycle, 1 Phase
OUTPUT 120 Volt, 35 Amp., 4.2 KVA

INPUT 226-256 Volt, 50/60 Cycle, 1 Phase
OUTPUT 240 Volt, 35 Amp., 8.4 KVA

THREE PHASE

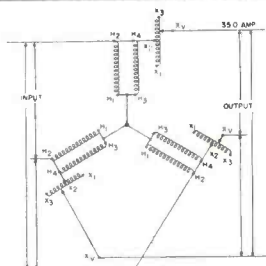

INPUT 240 Volt, 60 Cycle, 3 Phase
OUTPUT 210-270 Volt, 35 Ampere, 16.4 KVA

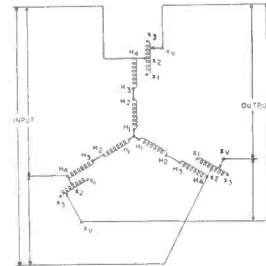

INPUT 480 Volt, 60 Cycle, 3 Phase
OUTPUT 450-510 Volt, 35 Ampere, 31.0 KVA

INPUT 452-512 Volt, 60 Cycle, 3 Phase
OUTPUT 480 Volt, 35 Ampere, 29.1 KVA

Be sure to see
SUPERIOR ELECTRIC'S
Mobile Display
when it is in your area



a precision product of
THE SUPERIOR ELECTRIC COMPANY

211 BRADLEY AVENUE, BRISTOL, CONNECTICUT

Send for Bulletin SE-L5571

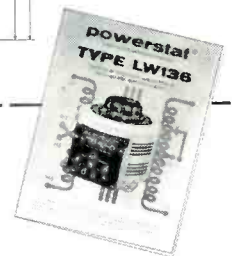

Offices: Los Angeles, California • San Francisco, California • Miami, Florida
Chicago, Illinois • Baltimore, Maryland
Detroit, Michigan • New York, New York
Cleveland, Ohio • Dallas, Texas • Seattle, Washington

Name

Company

Street

City Zone State



meters for every

Custom-built or Stock, Simpson Offers a Complete Line

To meet your special requirements, Simpson can build electrical panel meters in many combinations of size, range, type, and style. For meters in small quantities, you can select from 60,000 stock units (over 900 sizes and types) available for *immediate delivery* through your Electronic Distributor. Many stock models now have the *self shielded Core Magnet Meter Movement*.

These fine panel instruments are known throughout industry for their ruggedness and long-lived accuracy. Write today for Technical Manual No. 17.



SIMPSON ELECTRIC COMPANY

5200 W. Kinzie St., Chicago 44, Ill.
Phone: EStebrook 9-1121
In Canada:
Bach-Simpson Ltd., London, Ontario

instruments that stay accurate

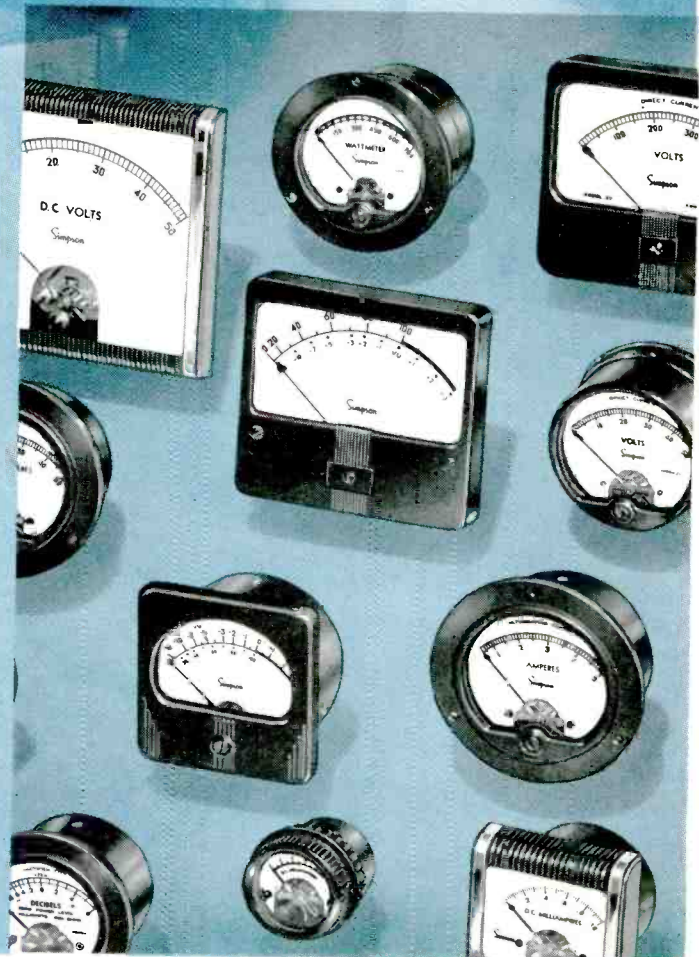

new



EDGEWISE



WIDE-VUE

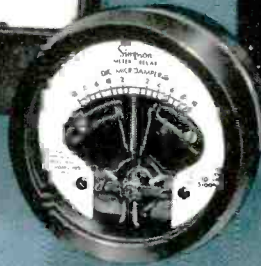

METER RELAY



ELAPSED TIME

need . . . Simpson

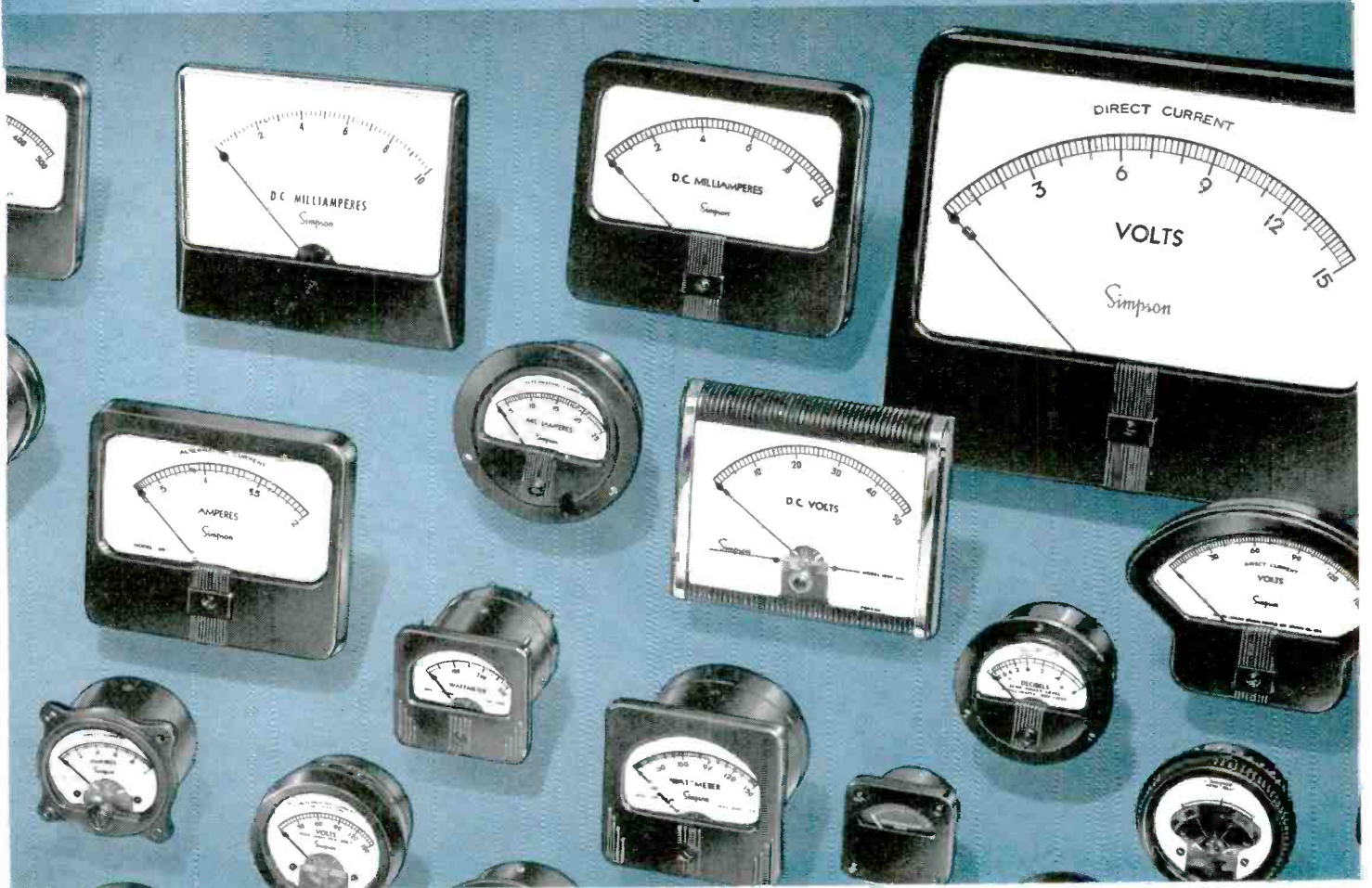

Today more than yesterday... tomorrow more than today

A dependable source of stable voltage

Today more than yesterday—and tomorrow more than today—circuit reliability and simplification is a



STANDARD-TYPE DESIGN for the 250-1000 va ratings range of Sola Constant Voltage Transformers shows compactness and simplicity of this static-magnetic regulator.

vital responsibility of the electronic and electrical design engineer. Where the problem is voltage control, utmost simplicity and reliability is provided by the Sola Constant Voltage Transformer.

Along with its simplicity, the static-magnetic Sola regulator offers many important advantages over other voltage stabilizers, some of which depend upon saturation of core materials for their regulating action; or other types employing tubes. The performance characteristics of Sola Constant Voltage Transformers have led to their widespread use in applications for which other types of regulators are unsatisfactory. Included are:

1. Completely automatic, continuous regulation of output within $\pm 1\%$ with primary voltage variations as great as $\pm 15\%$.

2. Response time of 1.5 cycles or less.
3. No moving or expendable parts or manual adjustments.
4. Self-protecting against short circuits or heavy overloads on output or load circuit.
5. Current-limiting characteristic protects load equipment from excessive fault currents.
6. Availability of transformation ratio for step-up, step down, plate and/or filament supply permits substitution in place of conventional non-regulating transformers.
7. Provides isolation between input and output circuits, often eliminating the need for "static shields."
8. Relatively compact compared to other equipment for comparable ac voltage regulation.

The basic-design Sola regulator—referred to as the Standard-Type Constant Voltage Transformer—is available from stock in capacities from 15 va to 10 kva in a variety of ratings. Many of these standard models can also be supplied for 25

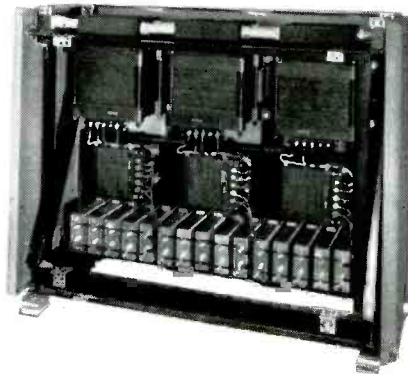

SPECIAL DESIGN above exemplifies adaptability of the basic Sola Constant Voltage Principle to special electrical or mechanical needs. This unit, rated at 9 kva—either single, or three-phase—delivers $\pm 1\%$ voltage regulation with negligible harmonic distortion.

and 50 cycle service, or with other input and output voltages, on a "build-to-order" basis.

Special adaptations of the basic design have resulted in six additional types of Sola regulators that meet a variety of voltage stabilization problems. Included are types that provide low harmonics in the output wave, regulation of electronic plate and filament voltage supplies, and lower-cost regulation for household appliance service.



LATEST ADDITION are these filament-voltage regulators in capacities up to 25a at 6.3v. Capacitor, at right, is wired separately from transformer for most compact mounting of the assembly as component in manufacturers' product.

Your letterhead request for "The Sola Constant Voltage Transformer—Theory of Design and Operation" will bring answers to your technical questions about the operation of the Sola regulator. This monograph includes a discussion of special adaptations of the basic-design voltage regulator. Specific information about transformer availabilities for your particular "component" or "end use" applications may be obtained promptly from your nearest district sales engineer. He's listed below.

SOLA Constant Voltage TRANSFORMERS

CONSTANT VOLTAGE TRANSFORMERS • LIGHTING TRANSFORMERS • CONSTANT VOLTAGE DC POWER SUPPLIES
SOLA ELECTRIC CO., 4633 West 16th Street, Chicago 50, Illinois, Bishop 2-1414 • BRANCH OFFICES: Boston, Mass.; Cleveland, Ohio; Kansas City, Mo.; Los Angeles, Calif.; New York, N. Y.; Philadelphia, Pa.; San Francisco, Calif.; Wallingford, Conn. • Representatives in Other Principal Cities
Sola Electric (Canada) Ltd., Toronto 17, Ontario; 102 Laird Drive, Mayfair 4554

THERE'S A GENERAL ELECTRIC IGNITRON FOR EVERY DESIGN NEED

Wide choice of Welding and Power Rectifier Tubes for the design engineer

STANDARD IGNITRONS

For Welding Service—KVA demand ratings from 300 through 2400 amps; or maximum average anode current from 22.4 through 355 amps.

For Power Rectifier Service—Continuous average amps 10 through 675; peak amps 30 through 3500; voltage ratings up to 20,000, inverse and forward.

CONVERTIBLE IGNITRONS

Available in same ratings as standard welding ignitrons (except GL-5550). Standard ignitrons have built-in thermal contact plate. Therefore, they can easily be converted to demountable-thermostat ignitrons.

Thermostat with flying leads—Thermostat gives over-temperature protection or water regulation.

Terminal-block thermostat—Thermostat gives over-temperature protection or water regulation.

TEMPERATURE-CONTROLLED IGNITRONS

Available in all welding and power rectifier ratings (except GL-5550). Over-temperature control and water regulation integral with tube.

PLASTIC-COATED IGNITRONS

Safety feature available on welding types. Red plastic shields workers from hazardous voltages. "DANGER ... VOLTAGE" stamped on plastic.

FACTORY-TESTED AT FULL RATINGS. Exclusive with General Electric is special factory test equipment that operates G-E ignitrons at full ratings under actual service conditions. You buy tubes proved-in-advance for service in your equipment. Every General Electric ignitron, moreover, is checked at the factory for the possibility of vacuum or water-jacket leakage.

HIGHEST-QUALITY IGNITORS. G-E ignitors will outlast others by as much as 2 to 1. Examples of 4-years-and-over G-E ignitor life are common; also cases in which G-E ignitors have outlived the tube. Reasons are: carefully controlled materials; holding the ignitor resistance to close limits; precision grinding.

CONTROLLED-GRAPHITE ANODES. By using a specially-developed electronic grade of graphite, with both density and size of particles controlled to tight limits,

General Electric is able to build ignitron anodes that stand up under extremely long and hard usage, give maximum life in heavy-duty service and under high-temperature conditions.

TRIPLE-DISTILLED-MERCURY POOLS. Mercury in G-E ignitron cathode pools is distilled to a point where impurity content is only 1 in 100,000 or less. Organic impurities, which can bring about gas formation, and inorganic materials, which can cause the ignitor to plate over, are held to a virtually irreducible minimum.

STABILIZED STAINLESS-STEEL JACKETS. General Electric uses stabilized stainless-steel for both inner and outer ignitron water-jackets. Characteristics of this material—its expansion and contraction, strength, chemical content—do not change with time or use. G-E ignitrons retain their full structural strength for life.

TURN THE PAGE FOR LIST OF G-E RECOMMENDED TYPES

CONSULT THIS LIST OF G-E RECOMMENDED TYPES FOR YOUR IGNITRON NEEDS

WELDING-CONTROL TUBES

TYPE NUMBER (All types available with plastic coating)	SIZE	SUPPLY VOLTS	MAXIMUM RATINGS**			
			KVA DEMAND	CORRESPONDING AVERAGE ANODE CURRENT, AMP	MAXIMUM AVERAGE ANODE CURRENT, AMP	CORRESPONDING KVA DEMAND
GL-5550	(A)	250-600 rms	300	12.1	22.4	100
GL-5551-A*	(B)	250-600 rms	600	30.2	56	200
GL-5552-A*	(C)	250-600 rms	1200	75.6	140	400
GL-5553-B*	(D)	250-600 rms	2400	192.0	355	800
GL-6346 ⊙	(B)	250-600 rms	600	30.2	56	200
GL-6347 ⊙	(C)	250-600 rms	1200	75.6	140	400
GL-6348 ⊙	(D)	250-600 rms	2400	192.0	355	800

*Can be converted to demountable-thermostat ignitrons using these kits:

Water Control N-15272AA (flexible lead) N-15286AA (terminal block)	Over-temperature Protection N-15273AA (flexible lead) N-15287AA (terminal block)
--	--

⊙ Built-in, temperature-controlled types. **Two tubes connected in inverse parallel.

FREQUENCY-CHANGER WELDING TUBES

TYPE NUMBER	MAXIMUM PEAK ANODE VOLTAGE		MAXIMUM ANODE CURRENT			
	INVERSE	FORWARD	PEAK	CORRESPONDING AVERAGE	AVERAGE	CORRESPONDING PEAK
GL-5551-A	1200	1200	600	5	22.5	135
	1500	1500	480	4	18	108
GL-5553-B	1200	1200	3000	40	140	840
	1500	1500	2400	32	112	672
GL-5822-A	1200	1200	1500	20	70	420
	1500	1500	1200	16	56	336
GL-6346 ⊙	1200	1200	600	5	22.5	135
	1500	1500	480	4	18	108
GL-6348 ⊙	1200	1200	3000	40	140	840
	1500	1500	2400	32	112	672
GL-6511 ⊙	1200	1200	1500	20	70	420
	1500	1500	1200	16	56	336

⊙ Built-in, temperature-controlled types.

POWER RECTIFIER TUBES

TYPE NUMBER	MAXIMUM ANODE RATINGS				
	PEAK VOLTS		PEAK AMP	CONTINUOUS AVERAGE AMP	AVERAGE AMP 1 MINUTE
	INVERSE	FORWARD			
GL-5779	350	350	30	10	—
GL-5554	900	900	900	100	200
	2100	2100	600	75	150
GL-5555	900	900	1800	200	400
	2100	2100	1200	150	300
GL-5564	900	900	3600	400	800
	2100	2100	2400	300	600
GL-5788 ■	900	900	1800	200	400
	2100	2100	1200	150	300
GL-6958	4000	4000	2000	300	600
GL-5630	20000	20000	200	50	50
GL-6228	20000	20000	900	150	300
GL-6512 ⊙	900	900	900	100	200
	2100	2100	600	75	150
GL-6513 ⊙	900	900	1800	200	400
	2100	2100	1200	150	300
GL-6514 ⊙ ■	900	900	1800	200	400
	2100	2100	1200	150	300
GL-6515 ⊙	900	900	3600	400	800
	2100	2100	2400	300	600

⊙ Built-in, temperature-controlled types.

■ Same ratings as GL-5555. These types will operate at higher water temperature and lower water pressure drop than type GL-5555.

POWER TUBE DEPARTMENT

GENERAL  **ELECTRIC**

9545-8481-3

SCHENECTADY, NEW YORK

.....
MARS outstanding design SERIES

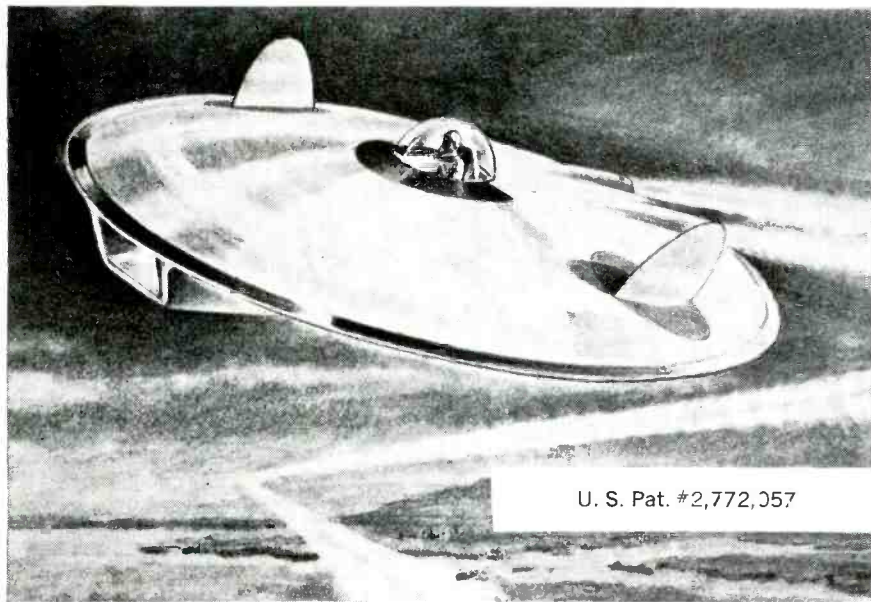

U. S. Pat. #2,772,057



John C. Fischer, Jr., San Diego professional engineer, one of the winners in the 1957 MARS Contest. Mr. Fischer's project, "Saucer Secret?," is featured in the MARS presentation on this page.

MARS announces new design contest

The MARS Outstanding Design Contest of 1957 created such wide interest that MARS Pencils is sponsoring another contest for 1958.

If you are an engineer, architect or student, the MARS contest offers you a "showcase." It provides you with a valuable opportunity to have projects you designed shown in leading magazines where they will be seen by the men in your profession.

You are invited to send in your projects. For every submission that is accepted

MARS pencils will pay you \$100

This \$100 is paid you simply for the right to reproduce your project in the MARS Outstanding Design Series. There are no strings attached. You will be given full credit. All future rights to the design remain with you. You can reproduce it later wherever you like and sell or dispose of it as you wish.

The subject can be almost anything — aviation, space travel, autos, trains, buildings, engineering structures, household items, tools, machines, business equipment, etc. Projects will be selected on the basis of appeal to design-minded readers, broad interest, attractive presentation. Do not submit a design that is in production. In fact, the project does not need to have been planned for actual execution. It should, however, be either feasible at present or a logical extension of current trends. It cannot be unrealistic or involve purely hypothetical alterations of natural laws.

There is no deadline for entries but the sooner you send yours in, the greater the probability of its selection for the 1958 MARS Outstanding Design Series.

It is Simple To Submit a Design For Mars Outstanding Design Series

Just mail in an inexpensive photostat or photocopy of the subject—one you can spare, since it cannot be returned—and a brief description.

If your entry is accepted, we will ask you to send in a clear photograph or rendering of the design (so that we can make a sharp photograph) suitable for reproduction—after which your material will be returned to you.

Send your entry to:

J.S. STAEDTLER, INC.

Hackensack, New Jersey

saucer secret?

Whose incredible design is the flying saucer?

These flying objects (unidentified, of course) maneuver at high speed, with human-crushing suddenness. Their unearthly behavior poses a perplexing problem to imaginative designers: how might man survive in them?

John C. Fischer, Jr. approached the problem with this circular aircraft and its unique control system, U. S. Pat. #2,772,057.

This "saucer's secret" is a rotatably adjustable shell (upper) and a pilot's compartment which *pre-rotates* toward the direction to be flown. The functional design "humanizes" saucers because the rotating provisions distribute *g-forces* laterally on the pilot, minimizing blackouts.

No one can be sure which of today's new ideas will become reality tomorrow. But it will be important then, as it is now, to use the best of tools when pencil and paper translate an idea into a project. And then, as now, there will be no finer tool than Mars—from sketch to working drawing.

Mars has long been the standard of professionals. To the famous line of Mars-Technico push-button holders and leads, Mars-Lumograph pencils, and Tradition-Aquarell painting pencils, have recently been added these new products: the Mars Pocket-Technico for field use; the efficient Mars lead sharpener and "Draftsman's" Pencil Sharpener with the adjustable point-length feature; and—last but not least—the Mars-Lumochrom, the new colored *drafting* pencil which offers revolutionary drafting advantages. The fact that it blueprints perfectly is just one of its many important features.

The 2886 Mars-lumograph drawing pencil, 19 degrees, EXEXB to 9H. The 1001 Mars-Technico push-button lead holder, 1904 Mars-lumograph imported leads, 18 degrees, EXB to 9H. Mars-lumochrom colored *drafting* pencil, 24 colors.



J.S. STAEDTLER, INC.
 HACKENSACK, NEW JERSEY

at all good engineering and drawing material suppliers



...when your product demands the highest standard of uniformity

BECAUSE of high metal purity plus exceptional uniformity in size and physical properties, Sylvania wire will help you hold rejection losses to a minimum . . . help you maintain consistently higher product performance standards.

Quality-controlled to the exacting standards known to be needed for producing the world's finest vacuum tubes—every step in the wire-making process is done in Sylvania's own plants. From metal refining to drawing and finish plating . . . one manufacturer bears the entire responsibility of supplying the exact kind and quality of wire you need.

There is a Sylvania wire for every vacuum and gas tube application, in a full range of sizes down to the finest available—bare or plated with gold, rhodium, silver or nickel. Extra-long lengths can be supplied on order.

As the specifications for tube characteristics vary—so your wire requirements will vary. Next time you need standard or special wires, call in your Sylvania sales engineer. He will help you get exactly what you need, *when you need it!*

SYLVANIA ELECTRIC PRODUCTS INC.
Tungsten and Chemical Division, Towanda, Penn.

TUNGSTEN

MOLYBDENUM

CHEMICALS

PHOSPHORS

SEMI-CONDUCTORS



SYLVANIA



Lighting • Radio • Electronics • Television • Atomic Energy

GOOD-ALL
CAPACITORS

THROUGHOUT THE INDUSTRY

... KNOWN AND RESPECTED

Three HEADLINERS from a broad line of fine quality capacitors

**GOOD-ALL Type 600-UE
Mylar* Dielectric... Molded In Epoxy**

A general-purpose tubular of extraordinary performance. Priced in the same range as molded paper designs, but a stand-out in stability and resistance to humidity.

SPECIFICATIONS

Dielectric Mylar Film	Temp. Range -55 to +125°C
Case Epoxy	IR at 25°C 100,000 Meg. x Mfd.
Voltage Range 100-1600	Power Factor 0.6% Max.

**GOOD-ALL Types 616-G and 617-G
Sub-Miniature Metal Enclosed Mylar* Designs**

Designed to provide EXTENDED LIFE at high temperatures. Rugged, military construction throughout. These lines include a 50-volt series for transistor applications.

SPECIFICATIONS	Temp. Range Full rating to 125°C, 50% derating at 150°C
Dielectric Mylar Film	D.C. Voltage 50, 100, 400 and 600
Case Hermetically Sealed	Rating
Winding Extended Foil	

* DuPont's trademark for polyester film.

Good-All EPOXY Coated Ceramic DISCS

Something really new! The tough, durable Epoxy coating provides excellent moisture resistance and high voltage breakdown strength. The lead entries are tightly sealed.

TYPES AVAILABLE	AC Line By-Pass Type D
Temperature Compensating Type A	Highly Stable Types E & EE
By-Pass Type B	High Voltage Type G
Dual Shielded Type C	Transistor Type H

Immediate Delivery on Standard Items.

Return inquiry card in back of magazine, and detailed brochures on the above capacitor types will be mailed to you promptly.

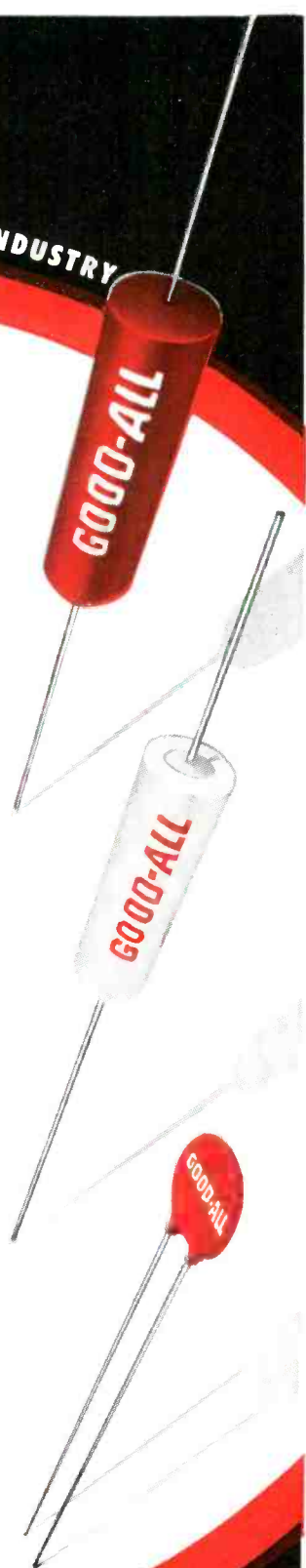

Soon in stock at your local distributor.



GOOD-ALL ELECTRIC MFG. CO. • OGALLALA, NEBRASKA

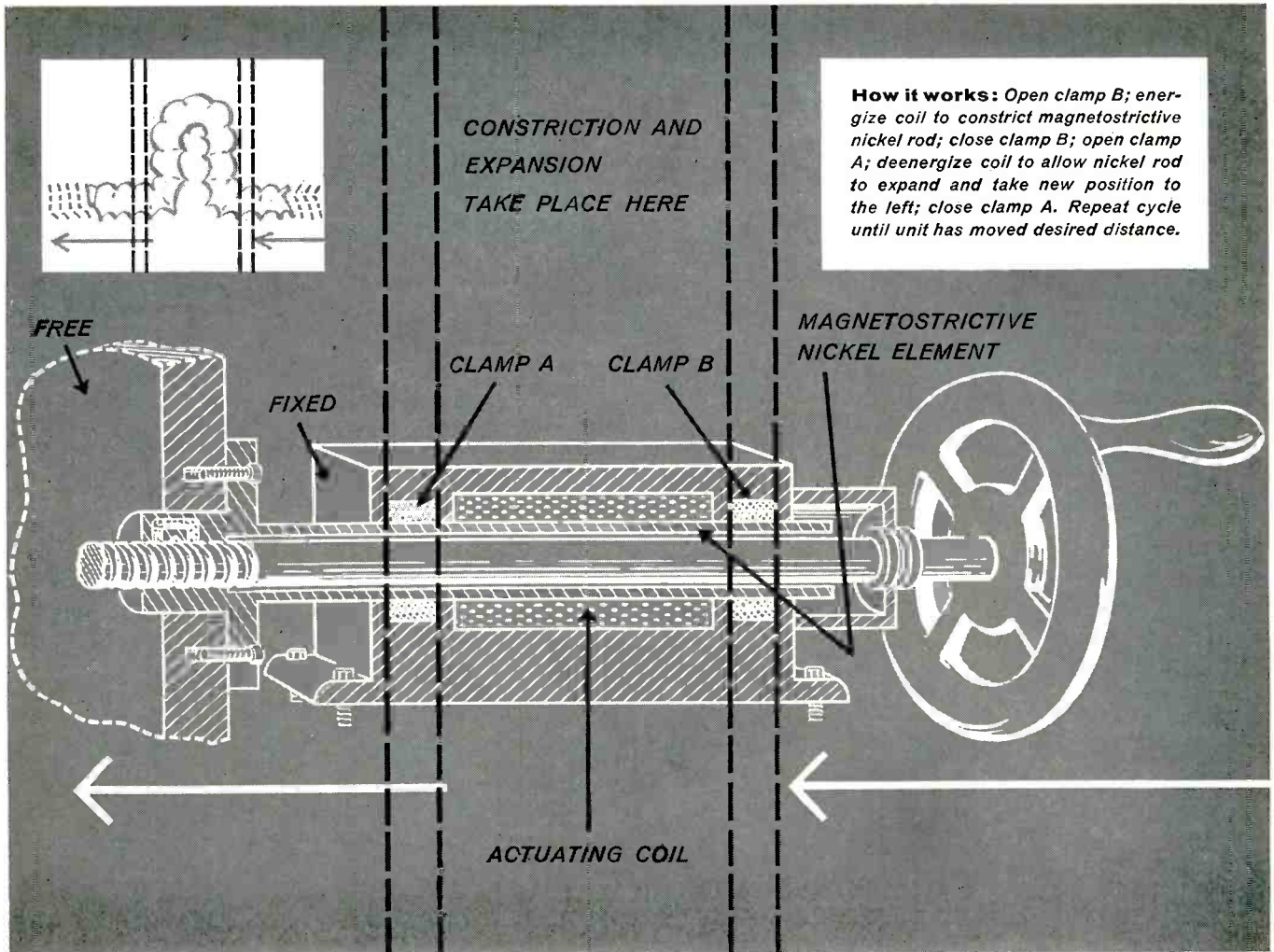

Novel Inchworm Motor positions work to 0.000,005-inch accuracy

New heavy-duty micro-feed relies on Magnetostrictive nickel

Place nickel in a magnetic field and it shrinks.

Remove it, and it snaps back to size.

Magnetostriction is the reason. And nickel exhibits large magnetostrictive length change . . . added to its rugged mechanical properties and moderate cost. Result: a reliable, versatile engineering material.

Take, for example, the novel "Inchworm" motor manufactured by Airborne Instruments Laboratory, Inc., Mineola, N. Y. An extremely accurate feed mechanism for center-

less grinders, this device uses a coordinated pair of clamps to convert the magnetostrictive expansion and contraction of a nickel rod into linear incremental motion. Powerful motion, too . . . the "Inchworm" will move a 350-pound load in steps variable up to 0.000,060-inch.

You can see the mechanics of The Inchworm in the illustration above. Electronic controls include standard timing and power circuits to energize the coil and operate the clamps for forward and backward steps. An optional gauge and feedback circuit

allow full automatic control.

Magnetostrictive transducers made of nickel have many industrial uses today . . . as sonar, vibratory drills, ultrasonic cleaners, homogenizers, soldering devices.

Maybe you would like to explore this growing design field. For recommended materials, get in touch with us. Write for our booklets, *Magnetostriction*, or *Design of Nickel Magnetostrictive Transducers*. They're yours for the asking.

The INTERNATIONAL NICKEL COMPANY, Inc.
67 Wall Street New York 5, N. Y.



NICKEL... for magnetostriction

See how
the facts speak
for themselves

hcd ^{*}RADIO RECEPTOR Petti-Sel SELENIUM RECTIFIERS are revolutionizing the field!

* high current density



Standard
rectifier

RRco. Petti-Sel
rectifier

- ▶ 100,000 hours estimated life
- ▶ Lower voltage drop
- ▶ Higher current density
- ▶ Less reverse leakage
- ▶ Smaller size

Both rectifiers are rated at 26V, 8 amps,
but notice the significant space saving in the
compact Petti-Sel unit.

compare the size ...



compare the specs ...

STANDARD SELENIUM RECTIFIERS								
NOMINAL CELL SIZE (INCHES)		RRco. CELL CODE	Continuous DC Amperes at 35° C Ambient					
Vert.	Horiz.		SINGLE PHASE			THREE PHASE		
			Half Wave	Center Tap	Bridge	Half Wave	Center Tap	Bridge
1.0	1.0	M	.11	.22	.22	.29	.40	.33
1 3/16	1 3/16	P	.23	.45	.45	.60	.81	.67
1.5	1.5	Q	.45	.90	.90	1.2	1.6	1.3
2	2	S	.70	1.4	1.4	1.8	2.5	2.1
3	3	U	1.6	3.2	3.2	4.2	5.8	4.8
3 3/8	3 3/8	V	2.0	4.0	4.0	5.3	7.2	6.0
4	4	W	3.0	6.0	6.0	8.0	10.8	9.0
4.5	5	G	3.75	7.5	7.5	10.0	13.5	11.2
4 1/4	6	T	4.2	8.5	8.5	11.0	15.0	12.5
5	6	H	5.0	10.0	10.0	13.3	18.0	15.0
6	7 1/4	L	7.5	15.0	15.0	20.0	27.0	22.5

RRco. PETTI-SEL SELENIUM RECTIFIERS								
NOMINAL CELL SIZE (INCHES)		RRco. CELL CODE	Continuous DC Amperes at 35° C Ambient					
Vert.	Horiz.		SINGLE PHASE			THREE PHASE		
			Half Wave	Center Tap	Bridge	Half Wave	Center Tap	Bridge
1.0	1.0	6	0.2	0.4	0.4	0.6	1.0	0.6
1.3	1.3	11	0.5	1.0	1.0	1.5	2.5	1.5
1.6	1.6	16	0.75	1.5	1.5	2.25	3.75	2.25
2	2	25	1.25	2.5	2.5	3.75	6.25	3.75
2.6	2.6	44	2.25	4.5	4.5	6.75	11.25	6.75
4	4	100	4	8	8	12	20	12
4	8	200	8	16	16	24	40	24
4	12	300	12	24	24	36	60	36
8	8	402	16	32	32	48	80	48
8	12	600	22.5	45.0	45.0	67.5	112.5	67.5
8	16	800	30.0	60.0	60.0	90	150	90

In case you haven't noticed, the yellow and gray areas denote actual comparative sizes of the two rectifier types.

and compare the prices! HCD Petti-Sel rectifiers, developed in Western Germany by Siemens and now made in the U.S. by Radio Receptor, offer many important electrical advantages over standard types plus economic advantages.

See for yourself — We'll be glad to send you further information on this remarkable new rectifier line. Submit your requirements to Section E-11R.

Radio and
Electronic Products
Since 1922



Semiconductor Division
RADIO RECEPTOR COMPANY, INC.
Subsidiary of General Instrument Corporation

240 WYTHE AVENUE, BROOKLYN 11, N. Y. • EVERGREEN 8-6000

Radio Receptor products for Industry and Government:
Germanium and Silicon Diodes, Selenium Rectifiers, Thermatron Dielectric Heating Generators and Presses, Communications, Radar and Navigation Equipment

new!...

RUGGEDIZED

micro-miniature Continental Connectors

NOW RUGGEDIZED TO WITHSTAND SHOCK AND VIBRATION EXTREMES



7 Contacts MM7-22

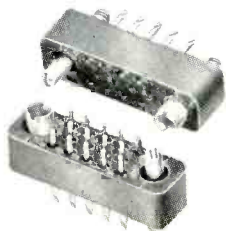

14 Contacts MM14-22



20 Contacts MM20-22

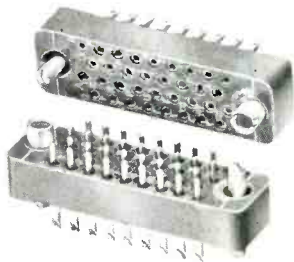

34 Contacts MM34-22

ACTUAL SIZE

- ★ Smallest size without sacrifice of performance
- ★ Available in 5, 7, 9, 11, 14, 20, 26, 29, 34, and 44 contacts
- ★ Positive polarization reversed guide pin and guide socket
- ★ Melamine . . . Plaskon . . . Diallyl Phthalate Molding Compounds
- ★ Available with hoods, screwlocks and protective shells

ELECTRICAL AND MECHANICAL RATINGS

Voltage Breakdown:	
At Sea Level	1800 Volts RMS
At 60,000 Ft.	450 Volts RMS
Current Rating	3 Amps.
Solder Cup (MM-22)	#22 AWG Wire
Minimum Creepage Path Between Contacts	1/8"
Minimum Air Space Between Contacts	3/64"
Contacts, Center-to-Center	3/32"
Pin Diameter (MM-22)	.030"

Technical data sheets on micro-miniature and other Continental Connectors are available on request. Specify your requirements to Electronic Sales Division, DeJUR-Amsco Corporation, 45-01 Northern Blvd., Long Island City 1, N. Y.

You're
always
sure
with

DeJUR

electronic
components

electronic sales division
DeJUR-AMSCO CORPORATION
45-01 northern boulevard
long island city 1, n. y.

Direct line solution to your closure problems!

- ALUMINUM
- COPPER
- BRASS



MArket 3-7584

- MU METAL
- STEEL
- STAINLESS STEEL

A complete solution to your closure problem is as near as your telephone! Chances are, Hudson can supply an economical standard stock item, from factory stocks, that will meet your requirements exactly. Where specifications call for unusual designs, Hudson can produce precision-drawn custom closures to meet your assembly line schedules.

Hudson standard and special closures are available with complete cover assemblies if desired. Quotations on sub-assemblies, including certified spot welding and silver soldering will be supplied promptly on receipt of your drawings and data.

Write or phone for a copy of the Hudson catalog on standard precision-drawn cases and covers

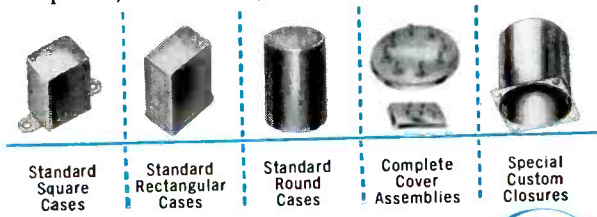

Standard Square Cases Standard Rectangular Cases Standard Round Cases Complete Cover Assemblies Special Custom Closures

HUDSON
TOOL & DIE CO • INC



18-38 MALVERN ST., NEWARK 5, N. J. — Tel. MArket 3-7584

For Thermostat Metal parts that



**control
compensate
indicate
TEMPERATURE**

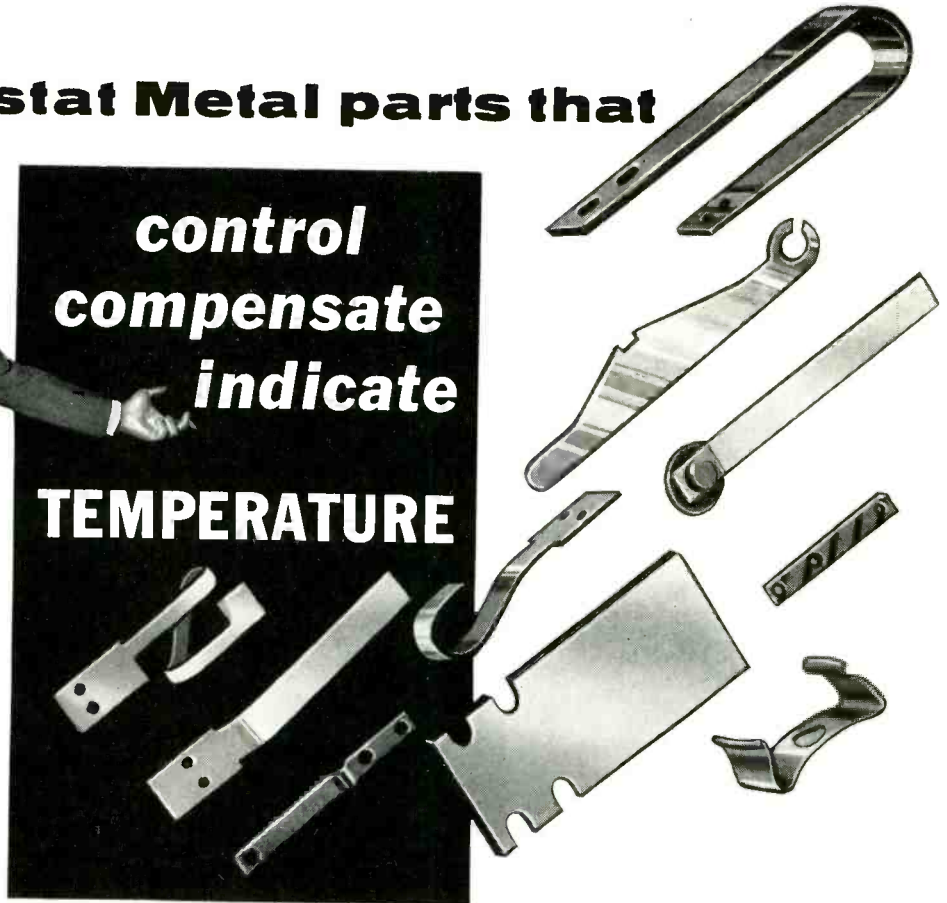

be sure . . . get

Truflex

Today hundreds of manufacturers depend on General Plate for thousands of thermostat metal parts that satisfy requirements involving thermal deflection, electrical resistance, and corrosion resistance.

Here's Why:

- Truflex parts and assemblies are engineered to your specifications, ready for installation.
- Every piece — in lots of 10 or 10,000 — is a duplicate of the original . . . eliminating rejects and costly assembly adjustments.
- Production problems, special equipment, and prolonged experimental work are all eliminated when you use Truflex parts.
- If you prefer to make your own parts, Truflex Thermostat Metals are available in extra long coils or flat strips manufactured to your exact specifications.

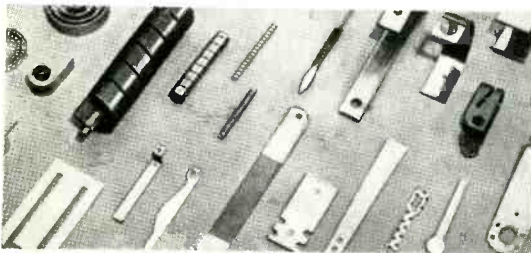

Send us a drawing of your thermostat metal parts and let us show what Truflex Thermostat Metal can do for you.

METALS & CONTROLS CORPORATION

General Plate Division



1311 Forest Street, Attleboro, Mass.

FIELD OFFICES: NEW YORK, CHICAGO, DETROIT, MILWAUKEE, LOS ANGELES

MICROWAVE PROGRESS

Signal Sources and Receivers

What a tankful of gasoline is to the automobile, the klystron tube is to the microwave system—a reliable and efficient power source.

Internal and external cavity type klystrons are used in PRD microwave oscillators. Both types belong to the reflex klystron group which is usually preferred because it provides easy tuning over a relatively wide frequency range and easy frequency or amplitude modulation.

The coaxial cavity is most often used for broadband oscillators since its principal mode is the *TEM*. This permits greater frequency coverage than either the *TE* or *TM* modes of rectangular waveguide sections.

PRD's line of signal sources is conveniently operated through the use of PRD Klystron Power Supplies. Electronically regulated beam, grid, and reflector voltages provide extremely stable klystron output signals.

A spectrum analyzer is a special type of self-contained receiver. It presents an instantaneous display of the power spectrum of the input r-f pulse on an oscilloscope screen. Basically, it is a superheterodyne receiver with a frequency modulated local oscillator.

While the analyzer delivers an accurate envelope of the pulse frequency spectrum, it does not necessarily display each frequency component, since the frequency separation between adjacent spectral lines on the screen is a function of the local oscillator sweep rate, f_s , as well as the PRF, f_R . Actually, the number of lines produced on the screen is f_R/f_s . By varying f_s , the operator can control the spectrum detail presented.

Data such as that contained in the foregoing paragraphs are available in our PRD Reports. Published periodically, these reports give practical information on virtually every aspect of microwave research and engineering. Mathematical derivations, graphs, and charts are always included. If you'd like to receive these reports (there's no charge of course), we'll be happy to add your name to our mailing list. Please address your request to: Reports Dept. 21.



Polytechnic Research and Development Co., Inc.

202 Tillary Street • Brooklyn 1, N. Y. • Tel: UL 2-6800
Cable Address: MICROWAVE, NEW YORK



PRD Klystron Power Supply for low and medium voltage klystron tubes

Three Protective Devices Prevent Klystron Burn-out!

Another first from PRD. A compact, easily transportable klystron power supply that provides: a protective diode to safeguard the reflector against turning more positive than the cathode; a fuse in the klystron cathode return to protect the beam supply; and a "Beam Off" position to allow for warming up of the klystron filament.

A special feature of Type 809 Klystron Power Supply eliminates readjustments when changing from cw to square wave modulation. The top of the square wave is automatically clamped to the previously chosen reflector voltage.

With good stability and regulation, and with square wave and saw tooth modulation plus provision for external modulation, Type 809 Klystron Power Supply is equally at home in the laboratory or on the production line.

		SPECIFICATIONS			
Output	Type	Voltage (volts)	Current (milliamperes)	Additional Specifications	
	Beam	Continuously variable 250 to 600	0 to 65	Ripple: < 5mv RMS	
	Reflector	Continuously variable 0 to -900	50 μ a max.	Ripple: < 10mv RMS	
	Filament	6.3	2 amperes	\pm 3% center tapped	
Modulation	Type	Frequency Range (cps)	Nominal Voltage (volts)	Rise Time (microseconds)	Decay Time (microseconds)
	Square Wave	400 to 2000	0 to 90	< 10	< 10
	Saw Tooth	60 (fixed)	0 to 125		

Clamping circuit maintains top of square wave within 2 V of cw reflector voltage.

Price—\$350 f. o. b. Brooklyn, N. Y.

For additional details on PRD 809 Klystron Power Supply, contact your local PRD Engineering Representative or write to Technical Information Group, Dept. 21.

Your 1958 electronics INCREASED EVERY in electronics

EDITORIAL COVERAGE x Selected Circulation = Increased Readership

Starting January 3rd 1958, *electronics* will publish alternate weekly *Business* and *Engineering Editions*, providing the most complete editorial service in the industry!

Based on extensive information gained through McGraw-Hill mail and personal interview studies . . . a weekly publishing frequency is required to provide expanded and timely editorial coverage.

LOOK AT THIS!

Survey Question #1: "In your work, do you need the information from *electronics* Business Editions, the Technical Editions or both?"

Answer: 88% of the respondents said *BOTH!*

Survey Question #2: "Have *electronics* Business Editions increased the magazine's value to you?"

Answer: 86% of the readers said YES!

Proof that technical and interpreted business information is vital to the electronics industry!

Survey Question #3: "How would you edit a magazine for the electronics industry?"

Sample Answers: "I'd write on manufacturing trends, market and business trends in the electronics field . . . a lead-off article on management and management problems should interest plenty of people who have a plant to run and a product to sell."

"I would have sections on new products, have space for Business News and always include something on circuitry and new components."

"General articles on all subjects . . . I feel that it's important for the man who has an overall general interest . . . and there are many younger men seeking knowledge constantly."

"All around information on new approaches in electronics, new methods, any advance ideas on improving electronics."

"Any new trends in the electronic industry, especially in the nature of component parts, new circuits and applications would be my feature articles."

These comments reflect the desires of all *three* industry levels influential in the purchase of your product or service . . . Design, Production, Management. Men in all fields of electronics — manufacturers, and users — have a community interest in *electronics* magazine!

During 1958 this interest will be shared by 52,000 paid subscribers in all phases of the industry.

Investigate the sales possibilities of *electronics* magazine in 1958 . . . write for 4-page reprint *electronics BECOMES A WEEKLY IN 1958*; new 52-time *Rate Card*, and *Publishing Cycle Chart* . . . or call in your local *electronics* representative today!

Only **electronics** SELLS ALL 3

... key buyers among manufacturers

Advertising Dollar Buys...

READERSHIP WEEK

...of course!

**electronics is vital
to your sales program**

- In 1958, **electronics** will deliver 52,000 paid subscribers per issue. (See *Printers' Ink Centerspread*, October 11, 1957.)
- **electronics** influences the important industry segments — design, production, management. (See *Printers' Ink Centerspread*, November 8, 1957.)
- **electronics** offers the most complete editorial service — 26 Engineering Editions — 26 Business Editions **PLUS** the Buyers' Guide — 53 effective ways to sell the market! (See *Printers' Ink Centerspread*, December 6, 1957.)

52

Weekly Issues—

Alternate

**Engineering and Business
Editions**

plus the Buyers' Guide

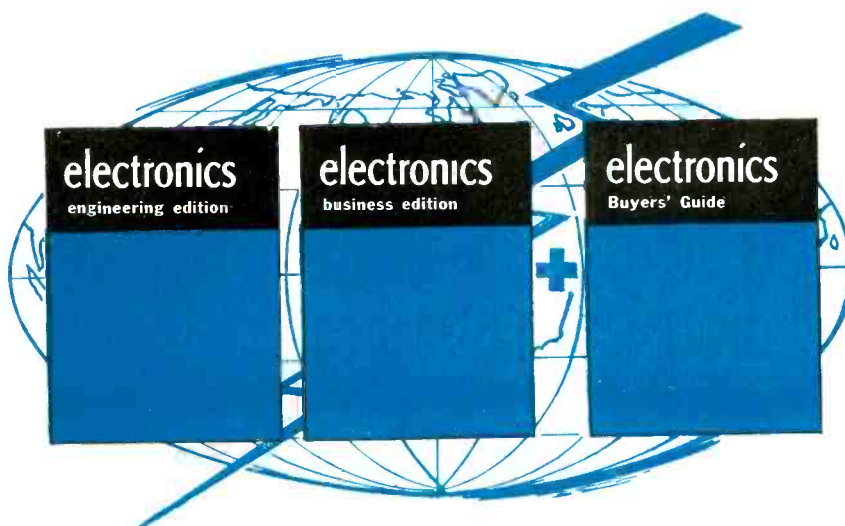

A MCGRAW-HILL PUBLICATION

330 W. 42nd Street, New York 36, N. Y.



DESIGN / PRODUCTION / MANAGEMENT

and users of electronic equipment

the new MALLORY XTM line

High-Temperature Tantalum Capacitors

...in miniature

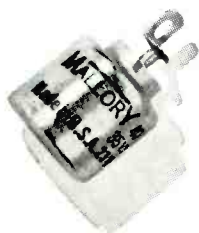

(SHOWN ACTUAL SIZE)

FOR THE FIRST TIME, true high-temperature tantalum capacitors are available in miniature sizes—in Mallory's new XTM line. These are premium performance grade capacitors designed for exacting service under severe conditions of temperature, humidity and mechanical shock, including temperatures such as are encountered in military equipment.

The Mallory XTM line embodies refinements of design and manufacturing techniques originally pioneered by Mallory in the development of high-temperature capacitors. They will withstand temperatures from -55 to $+175^{\circ}$ C. Mallory XTM's are

available in capacities from 4 to 40 mfd., at from 35 to 360 volts nominal. True metal-to-glass hermetic seals are used for positive protection against humidity.

Metal case diameter (all capacities) is only $\frac{5}{8}$ "', with case lengths ranging from $\frac{9}{16}$ "' to $1\frac{25}{32}$ "'. A choice of $2\frac{1}{4}$ "' axial leads or solder tab terminals is offered.

Write—or ask your nearest Mallory representative for complete engineering information, specifications and application data on the new XTM miniature tantalum capacitor line.

Serving Industry with These Products:

Electromechanical — Resistors • Switches • Tuning Devices • Vibrators
Electrochemical — Capacitors • Mercury and Zinc-Carbon Batteries
Metallurgical — Contacts • Special Metals • Welding Materials

Parts distributors in all major cities stock Mallory standard components for your convenience.



Photoelectric Target for Missile Tests

SUMMARY — Rectangular coordinates of test missile can be determined at selected point along its trajectory by two banks of multiplier phototubes located at ground level. Each phototube in banks sees narrow segment of sky; missile passing through segment momentarily decreases light incident on phototube causing output pulse. Phototube banks, acting together, give coverage of flight area. Varying slit width changes area covered

By **SAMUEL E. DORSEY**

*Ballistics Division
U. S. Naval Ordnance Test Station
China Lake, California*

IN MISSILE TESTS, it has been customary to set up extensive as well as expensive targets of cardboard or other material, strung between poles placed at strategic points along the trajectory of the missile to obtain the rectangular coordinates. Break wires placed at certain locations establish a measurement of time.

This article discusses a proposed photoelectric target that uses electronic means to determine the rectangular coordinates of a test missile at a selected point along its trajectory. It also gives an indication of the time of passage through this point. The target is to be used in conjunction with tests where the trajectory of the missile lies close to the ground, as in cross-wind firing.

System Description

With the photoelectric target, a fairly accurate indication of these data can be obtained from equipment situated at ground level.

The five units comprising this system are two banks of phototubes in their light-restricting

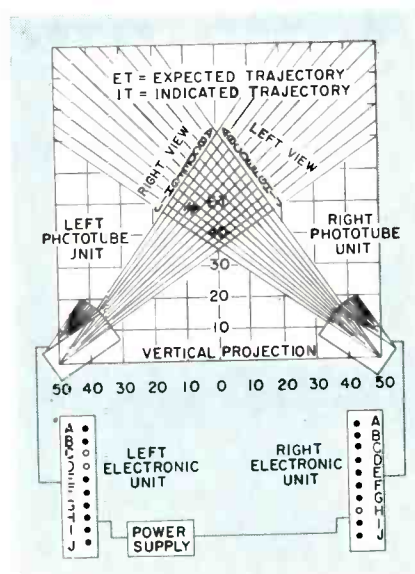

FIG. 1—Elements of target system. Upper half of diagram represents theoretical set-up for expected trajectory of 50 ft and small dispersion

boxes, two cabinets of electronic apparatus for control and indication and a power supply cabinet as shown in Fig. 1.

One bank of phototubes is placed on the ground to the left of the vertical projection of the expected trajectory, at a distance equal to its height. The other bank of phototubes is similarly placed to the right of the expected trajectory path.

Bank Construction

Each phototube bank consists of ten multiplier phototubes with each phototube mounted at the bottom of an elongated box constructed so light that impinges upon the phototube must pass through an adjustable slit in the top of the box as well as a small square hole in front of the phototube.

Each box is adjustable in direction and slit length so that each phototube sees a narrow segment of the atmosphere with sky in the

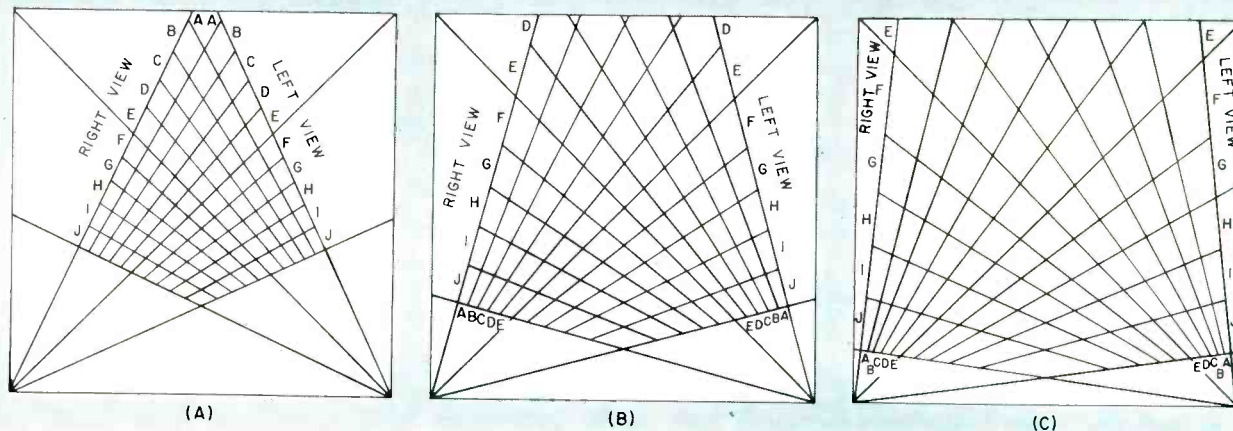

FIG. 2—Charts interpret meaning of lit indicator lamps for spacings and slit lengths of 4 (A), 6 (B) and 8 (C) degrees

background. If the missile passes through the segment, the momentary decrease of the light will be evidenced by a pulse of current in the phototube.

The ten phototubes when properly adjusted cover, fan-fashion, a thin slice of the range area extending above and below the expected trajectory to include the entire region of possible dispersion. The two phototube units, acting in different directions, give a sort of stereoscopic coverage of the flight area.

Readout

In each electronic unit, there are ten neon lamps, one for each phototube. These lamps are represented by the small circles in the lower half of Fig. 1.

When the missile cuts across some of the light received by any phototube, the corresponding circuitry in the electronic unit causes the phototube's neon lamp to light and remain lit. Simultaneously,

the electronic unit lights the main pilot lamp and delivers a pulse into its timing output. The circuits between the nine other phototubes and their neon lamps are then quickly locked out. Therefore, about one millisecond after any one phototube within the unit has caused its corresponding neon lamp to light, no other neon lamp in that electronic unit can light.

Should the missile cut across the very edge of the field of view of one of the phototubes where there is slight overlap by the field of view of the adjacent phototube, both phototubes would light their neon lamps before the lockout action could take place.

Test Setup

The upper half of Fig. 1 represents a theoretical test setup where the expected trajectory is 50-ft high and the dispersion small. The phototube units are each set 50-ft from the expected trajectory path and adjusted for 2-degree opera-

tion (2-degree slit length and 2-degree separation).

The lighting of neon lamps *C* and *D* in the left electronic unit and lamp *H* in the right electronic unit, shows an indicated trajectory through a region 7 to 9 feet to the left of the expected trajectory and zero to 2 feet below it.

To interpret the meaning of the lamps, a series of charts, similar to that in Fig. 2, has been made for the phototube box spacing and slit lengths of 2, 4, 6 and 8 degrees.

Electronic System

A block diagram of the electronics of one side of the target system is shown in Fig. 3.

Ten multiplier phototubes, each with its separate regulator circuit, feed ten amplifier channels. Each channel in turn feeds a thyatron. Output circuits from all ten of the thyratrons are tied together to form a common signal bus which makes up the input of three other amplifiers: a lockout amplifier which renders inoperative all ten amplifier channels whenever one or more thyratrons are conducting; a pulse amplifier which generates the timing pulse and a relay amplifier which causes the pilot lamp to light.

This application of phototubes presents the problem of changes in average level of illumination on the cathodes of the phototubes. These changes are brought about by several factors: the manual changes in slit length at the top of the restrictive housing of each phototube in setting up the target for different

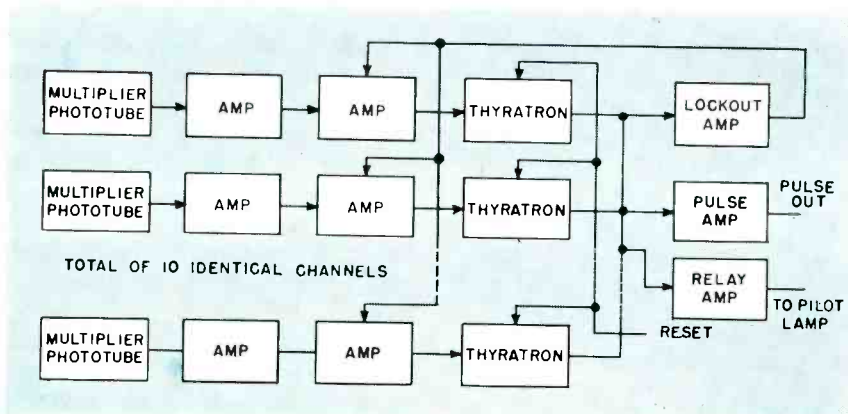

FIG. 3—Block representation of one side of electronic portion of target system



Inside view of one phototube box shows arrangement of slits

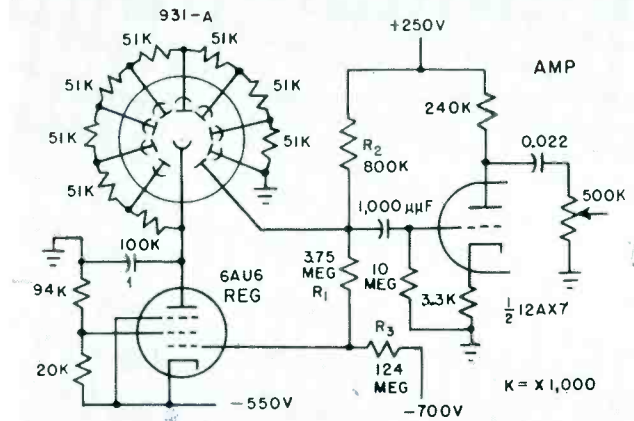

FIG. 4—Regulator compensates for illumination changes

angular sizes of target area; the angles from the horizon at which the field of view of each phototube is directed; the nearness to the sun at which each phototube is directed; the time of day and the weather. The first factor introduces a variation of 4:1. It can be estimated that the variations for the other factors are quite large.

Phototube Regulators

These changes in illumination are compensated for with a regulating circuit for each phototube, as shown in Fig. 4.

Resistors R_1 to R_3 form a voltage divider between the +250-v supply, the anode of the phototube, the control grid of the 6AU6 and the -700-v supply. When the anode voltage is about +60-v, the control grid of the pentode is held

at about -5-v with respect to its cathode (-550-v with respect to ground). This range of control grid bias causes the 6AU6 to drop enough voltage from the phototube supply of -550-v to hold the anode voltage of the phototube at its +60-v value. If the anode of the phototube were nonconducting, the voltage divider would prevent its voltage from rising above +100-v. These conditions set the sensitivity of the phototube to a value which remains adequate.

Control Circuits

A simplified diagram of the circuitry remaining is given in Fig. 5. The second amplifier triodes are fed from the gain controls. The second amplifier plates are tied through coupling capacitors to the control grids of the thyratrons.

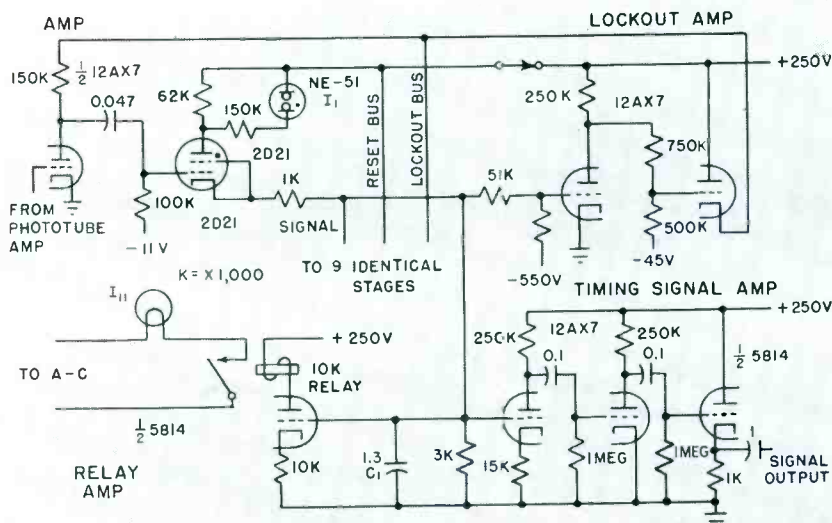

FIG. 5—Lockout, timing-signal and relay amplifiers are common to all ten signal channels

The plate of each thyatron is fed through a parallel combination of load resistance and indicator neon lamp circuit to the reset bus, which is tied through the normally closed push-button reset switch to the positive plate supply.

The cathode and shield of each thyatron are tied through a filtering resistance to the common signal bus. The voltage on this bus, under conditions of reset, is approximately zero, rising to approximately 10-v when any one thyatron starts conducting. This voltage rise forms the input to the lockout, timing signal and relay amplifiers.

Lockout

The lockout amplifier amplifies and inverts the voltage rise and applies it through the cathode follower to the lockout bus, which furnishes plate supply for all the second amplifiers. The starting voltage of the bus is high enough so the second amplifiers can operate properly. After one of the thyratrons starts conducting and after a delay caused by the charging of capacitor C_1 , the voltage of the lockout bus is reduced to a value so low that its associated second amplifier can no longer operate.

The timing signal amplifier is a two-stage amplifier with a cathode follower output.

The relay amplifier is cathode biased so it can draw enough plate current to actuate the relay only after the rise of voltage on the signal bus. The contact of this relay controls indicator lamp I_{11} .

Semiconductor Compounds

By ABRAHAM COBLENZ

Senior Engineer, Germanium Devices
Ohmite Manufacturing Company
Skokie, Illinois

SUMMARY — Comprehensive survey of semiconducting compounds distinguishes these materials from conventional semiconductors and discusses their characteristics, unusual properties and applications, both present-day and future. Tables of intermetallic and dye semiconducting compounds show all important presently available facts on these materials

AN UNUSUALLY fertile field for further investigation and commercial exploitation is that of semiconducting compounds.

A semiconductor is a substance with a resistivity in the range between that of metals and insulators, roughly from 0.005 to 10^8 ohm-cm, and whose resistivity decreases with temperature in some temperature range. Some degree of photoconductivity and rectifier action are usually exhibited; however, not all exhibit transistor action to a useful degree.

Definitions

Compounds are composed of two or more constituent elements with properties different from those of the elements.

Metals exhibit hardness, good electrical and thermal conductivity and have a typical luster. These metals are usually, but not always, ductile malleable and may be base-forming.

The term intermetallic compound is often misused. Thus Mg_2Si , GaP and InAs are frequently found listed among the intermetallics, but are not intermetallic by definition.

Organic compounds have one constituent element as C and frequently also H. On this general basis, which is historic rather than scientifically desirable, an inorganic compound is one containing any other elements, but may contain C as well (SiC). Thus the distinction is not rigorous and the overlap between the organic and

inorganic compounds is accepted.

A solution is a mixture of elements or compounds characterized by complete homogeneity, an absence of settling or separation, and minute subdivision down to molecular magnitudes. When the result is a solid or the process of solution takes place while the constituents are in the solid state, it is called a solid solution.

Uses and Applications

Virtually all semiconductor transistors and diodes today use germanium or silicon. Diodes made of selenium or copper-oxide, fall into the category of the semiconductors. These materials have limits in the coming world of higher speeds, higher temperatures, higher frequencies and higher powers.

Since the energy to bring holes or electrons across the forbidden energy gap varies with kT , a higher energy and therefore temperature are required to increase the number of carriers significantly for a material with an energy gap of 3 eV compared to the temperature required for a material with an energy gap of 1.1 eV.

One may thus infer that in Table I, with other parameters constant, the permissible upper operating temperature increases going down from Si and decreases going up from Si. For instance, Ge devices will operate satisfactorily approximately up to 65 to 70 C, as compared to 125 C for Si.

Alpha cut-off frequency for

transistors is given to a good approximation by

$$f_{\alpha_{co}} = \frac{kT}{\pi e w} \mu_n \text{ for } n \text{ type material} \quad (1)$$

$$f_{\alpha_{co}} = \frac{kT}{\pi e w} \mu_p \text{ for } p \text{ type material.} \quad (2)$$

Other parameters equal, the frequency response is directly proportional to the mobility (μ) to a good degree of approximation. On this basis, if a transistor could be made of InSb, for example, it would have a frequency response, for the same barrier width w , 57,000/1,400 or over 40 times the frequency response for one made of Si and over 15 times compared to Ge.

Compounds like InSb, InAs, MgTe, GaSb and HgSe could be superior to silicon for transistor applications in the matter of frequency response with all other parameters constant; while InP, GaAs and diamond could be superior to silicon in frequency response and upper temperature of operation.

For high-power operation, one problem is to remove the I^2R heat

All compounds below silicon in the table might well outperform silicon for power applications.

Forbidden Band Width

An attractive variation of effective forbidden band width is afforded by solid solutions of some semiconductor elements and compounds. Silicon and germanium form a series of solid solutions with a continuous distribution of

Open New Horizons

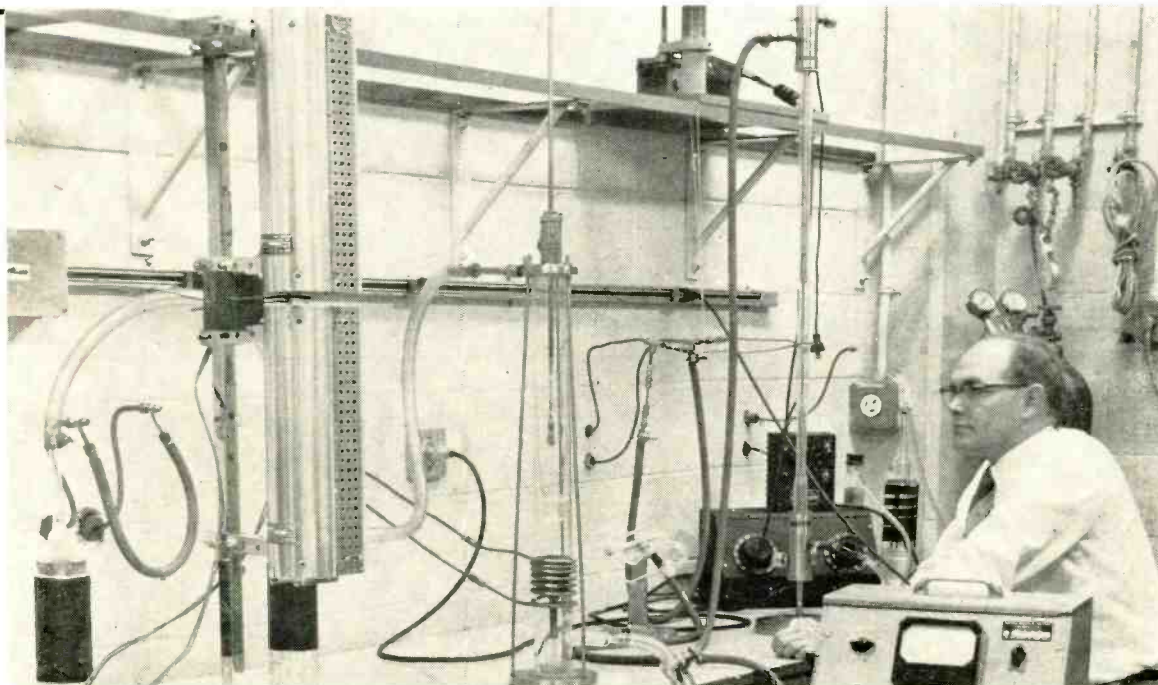

Floating-zone purifier (left) and single-crystal puller (center) are used for AlSb and InSb compounds

each element from 0 to 100 percent. The resulting alloy has a forbidden band width varying continuously from $E_g = 0.72$ ev for 100-percent Ge, to 1.09 ev for 100-percent Si.

A similar set of solid solutions is obtainable for S, ($E_g = 2.05$) and Te, with the energy gap varying continuously from 0.34 ev to 2.05 ev. Similarly, compounds GaP and GaAs form a continuous series of solid solutions with a continuous variation of energy gap; so do also InAs and InP, and HgSe and HgTe. Other mixtures of this type have been reported. One thus sees the practicability of a custom-made forbidden energy gap.

The potential of semiconducting compounds stems in part from the wide range of controllable parameters to choose from, in part from the possibility of choice of semiconducting elements taken two, three (CuFeS_2) and even four at a time (CuFeSnS_4 , $\text{Ti}_2\text{SeAs}_2\text{Te}_2$) and in part from combinations of these compounds in intermixtures.

Cooling

Current flowing through a junction of dissimilar metals can pump

heat from one junction to another in a two-junction system called a couple; this is the Peltier effect. Its inverse, creation of current flow by application of heat is the Seebeck effect. The rate of change of the emf acting in such a couple with temperature is the thermoelectric power; this parameter, measured with respect to some specified material like Cu or Bi, is a useful figure of merit of the material in refrigerating device.

Other characteristics of materials which determine refrigeration efficiency are electrical and thermal conductivity, mobility and atomic weight. It has been found that Ge and Si are poor for this purpose compared to, for example, bismuth telluride for which 40 C cooling for a single couple has been reported.

Special Effects

Magneto resistance is the change of resistance in the presence of a magnetic field change. For InSb a field change of 10,000 oersteds will produce a resistance change of 20:1. Such marked changes of resistance with magnetic field strength are not possible with Ge or Si.

In piezoresistance, pressure

causes changes in resistance and mobility. Here again, InSb or InAs is much superior to Si and Ge. Pressure meters have been made using this principle.

The galvanomagnetic or Hall effect can provide an output power of 1/200 microwatt for a 1-deg rotation of a suitable element of InSb in the earth's magnetic field. This is equivalent to an effective multiplication of the earth's magnetic field by a factor of about 1,000 and points the way to ultrasensitive magnetic compasses.

Using photoconductive effects, InSb exhibits a usable change in resistivity upon irradiation with infrared wavelengths up to 7.5 microns, considerably more than Ge. The wavelength up to which a substance will pass radiation impinging upon it, filtering out, or reflecting, all radiation of a higher wavelength, is frequently called an absorption edge. This factor is given by $h\nu/E_g$ in microns and when E_g is in ev, the absorption edge = $1.24/E_g$ (3).

For Ge, with an energy gap of 0.72 ev, the absorption edge is at 1.73 microns, for InSb it is about 7.15 microns. For InSb, by adding

Te, this absorption can be varied continuously up to the maximum indicated providing with a tailor-made absorption edge in an infra-red filter.

Applications Wanted

A number of unusual effects have been reported which seem to plead for applications. At 80 K, mobilities in InSb of the order of 500,000 cm²/v-sec and in lead salts (PbS, PbSe, PbTe), in the presence of a

magnetic field at 4.2 K, of the order of 750,000 cm²/v-sec have been reported.

Another interesting effect indicates the persistence of photocurrents in various semiconducting compounds for days at room temperature after removal of the radiation.

With regard to infrared sensitivity PbS cells are superior to thermocouples when used as the sensitive element. For longer wave-

lengths and approximately equal sensitivity, PbTe cells are used; PbSe cells extend further into the infrared toward radar frequencies, with a sensitivity somewhat less than that for PbTe, but still an improvement over any thermocouple.

Luminescence

Luminescence is light emission not resulting from high heat or incandescence. When achieved with an almost complete absence of

Table 1—Characteristics of Inorganic Semiconducting Compounds (Mainly Intermetallics)

1	2	3	4	5	6	7	8	9	10	11	12	13	14
Symbol	Name	Str	E_g	β	ρ_i	μ_n	μ_p	τ	Dens	M.P.	K	α	Applications and Remarks
Bi_2Te_3 §	Tetradymite	Rh	0.15		0.03	800	400		7.7	573		4.38	Electric refrigeration material
InSb	Indium antimonide	Z	0.17	3.3	0.0045	57,000	780	3	5.77	523	16.8	6.48	Highest mob
Mg_2Sn	Magnesium stannide	F	0.20	3.4	0.6	250	200	250	3.59	778		6.76	Anomalous behavior
PbSe	Clausthalite	N	0.25	4	0.25	1,400	950	0.6	8.1	1,065		6.14	Type changes at 77K
PbTe	Altaite	N	0.28	4.5	0.01	2,100	840	310	8.16	911		6.45	Infra-red detector
Te §	Tellurium	H	0.34	1.8	0.6	1,300	600		6.25	452	10.8	4.45	Eolotropic
Bi_2Se_3 §	Castillite	H	0.35		0.06	600			6.82	710		4.14	Also called guanajuatite
InAs	Indium arsenide	Z	0.37	4	0.1	22,600	200			940p	11.6	6.04	Anomaly: μ_p higher at 400C
PbS	Galena	N	0.4	4.7	3.1	650	250	2,800	7.5	1,117		5.97	Photoresistor
HgTe	Coloradoite	Z	0.4			11,800	100		8.07	670		6.43	Ionic-bond semiconductor
CuFeS_2	Chalcopyrite	O	0.53						4.2	875		5.24	Point-contact rectifier
Mg_2Ge	Magnesium germanite	F	0.6			400	100		3.09	1,115		6.38	
HgSe	Tiemannite	Z	0.65			10,000			8	690		6.07	Semiconductor when liquid
GaSb	Gallium antimonide	Z	0.69	3.5	0.06	4,000	750			702	11.6	6.13	Type changes at 357 C
Mg_2Si	Magnesium silicide	F	0.7	6		400	70		1.88	1,102		6.34	Dope with silver to get p
Ge	Germanium	D	0.72	2.2	47	3,600	1,750	1,000	5.32	937	16.4	5.66	Element
InSe	Indium selenide	P	0.96		12,500		5			660			Sensitive in uv, i-r and near i-r
Si	Silicon	D	1.09	3.6	300,000	1,400	410	2,500	2.33	1,417	11.7	5.43	Element
InP	Indium phosphide	Z	1.25	4.7	10	3,500	650			1,060		5.86	Point-contact diodes
GaAs	Gallium arsenide	Z	1.35	5.2	5×10^7	4,000	450	20		1,260		6.63	Solar battery, X-ray dosimeter
CdTe	Cadmium telluride	Z	1.45	3.6	2×10^4	400	60		6.2	1,050	10.9	6.46	Type changes at 300 C
AlSb	Aluminum antimonide	Z	1.55	3.8	0.5	70	150		4.25	1,060	4.8	6.14	Point-contact diodes
Sb_2S_3	Stibnite	O	1.55		5×10^8				4.6	548	9.6	11.2	300-piv diodes
CdSe	Cadmium selenide	Z	1.77	4.6	0.05	900		10000		1350p		6.05	Photosensitive
ZnTe ¶	Zinc telluride	Z	2.1		10^{11}		50		5.6	1,239		6.09	Photosensitivity varies with intensity
GaP	Gallium phosphide	Z	2.29	5.5		1,000						5.44	Electroluminescent
In_2Te_3	Indium telluride	P	2.4		160				5.78	667		18.4	
CdS ¶	Greenockite	Z-W	2.4	5.2	10^{13}	250	20	1,000	4.82	1,850	11.6	5.82	Many applications in phosphors
ZnSe	Zinc selenide	Z	2.6	7.2		100			5.42	1,000		5.66	
AlP	Aluminum phosphide	Z	3.0							1,050		5.42	
ZnO	Zincite	W	3.2		5	200	180		5.68	1,975	12	3.24	Ionic bonding
SiC	Carborundum	Z	3.5			60	8		3.17	2,700		3.1	Several forms
ZnS	Sphalerite Wurtzite	Z W	3.7	3.6	4.5×10^9				4.09	1850p	16.6	5.42	Thermoluminescent; phosphors
TiO_2 ¶	Rutile	T	3.7						4.10	1,020		3.81	
C ¶	Diamond	D	6		10^{16}	1,800	1,400		3.51	3,800	16.5	3.56	Good point-contact rectifier

sensible heat, it is called phosphorescence, the glow of the lighting bug for example. When achieved in the presence of an electric field, or electric potential difference, it is called electroluminescence.

Phosphors

Materials known to exhibit these phenomena are collectively called phosphors. Among these are semi-conducting compounds such as CdS, ZnS, ZnO or ZnSe which exhibit a luminescence under suitable conditions. Under d-c excitation, the phosphors show luminescence only upon application or removal of potential, much like the secondary voltage of a transformer; therefore pulse or sinusoidal voltages are used. When the luminescence is produced by radiation in some particular frequency range, it is called photoluminescence; the frequency or color of the reemitted radiation need not be the same as that of the incident radiation and can be controlled to some extent.

New photoconductive materials promise high response speeds, with applications to infrared and x-ray frequencies instead of the visible light spectrum. It is possible to use a solid-state screen as the target in an ordinary cathode-ray tube, where the electron beam acts as the source of illumination for the photoconductor.

Tables

Tables I and II represent a compilation of data from many sources; the figures can be considered current up to Feb. 1957. Complete lack of some data is indicative of the early state of the art.

Many of the compounds have been investigated only superficially (InSe, In₂Te₃). The many gaps in the tables also indicate the amount of research still necessary even in compounds that have been relatively well investigated.

The appearance of Table II shows that the study of the organic compounds has just begun; moreover, the data does not present the accuracy in such determinations that is usually desired. Standardization of procedures and definitions of terms in different laboratories

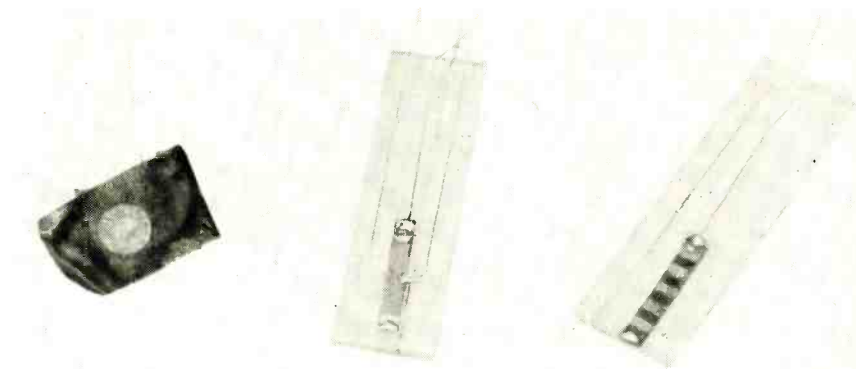

Photovoltaic cell at left is constructed of AlSb; InSb Hall-effect element is at center and InSb magnetoresistance element for chopper is shown at right

and in different countries is in an infantile stage; in some cases different technicians from the same laboratory have reported differing values of parameters, using the same or different techniques. With these facts in mind, reference has been made to as many authorities as possible and averaging methods have been applied.

In column 1 of Table I, the symbol § next to a formula indicates that the compound or element exists in two physical forms and characteristics parallel and perpendicular to a major axis, usually the C axis, may be different. Items marked ¶ have a resistivity so high that they border on the domain of insulators; their claim to the semiconductor family resides principally in their negative temperature coefficient of resistivity.

In column 3, the structural abbreviation are: D, Diamond; F, Fluorite; H, Hexagonal; N, NaCl; O, Orthorhombic; P, Pyrite; R, Rhombohedral; T, Tetragonal; W, Wurtzite; Z, Zinblend.

Energy-Gap Determination

Column 4 shows values of forbidden band width in electron volts, at room temperature. The energy gap can be determined by optical methods as suggested by Eq. 3, from change of conductivity with temperature, from Hall-effect data, from radiation recombination measurements, from the photoconductivity excitation spectrum, luminescence excitation spectrum or luminescence edge emission.

The number of the various methods, when combined with the different techniques of different investi-

gators in different laboratories, indicate that the results will not be too consistent. The energy gap also appears to give different results depending on whether the material used is *p* or *n*. In some cases, Te and Bi₂Te₃, for example, the energy gap varies with the direction of current flow in the crystal, depending on the orientation in the crystal holders; in others, CdS and ZnS for instance, the gap varies with the crystal type. In all such cases, the higher value has been reported.

Temperature

Energy gaps have been converted to room temperature values from known data regarding β , the change of energy gap with temperature given in column 5. The value of $\beta = dE_g/dT$, must be multiplied by 10^{-1} to convert to eV per degree K. Some writers report this value in degrees C, others in degrees K.

Here again several methods are used, such as absorption spectrum data and photoconductivity data and results are not too consistent. A particular precaution to be observed here is that β is often a function of the temperature range under study, rather than being constant over the entire range over which the material exhibits semiconductor properties.

Intrinsic resistivity ρ_i is given in ohm-cm. Here also an averaging process is used. Resistivities parallel and perpendicular to the principal axis for tetradyomite and tellurium are different and the larger value has been reported. In some cases, the figures do not necessarily represent intrinsic resistivity since

the extent of present investigations is inadequate to verify that the figures quoted are indeed intrinsic resistivities. In such cases also, the highest resistivity reported has been used in the averages.

Mobility

The mobilities given in column 7, in cm/sec per volt/cm may be Hall, drift or conductivity mobilities, including or excluding scattering effects. Even for materials as relatively well investigated as Ge, Si or InSb, values of mobility differ significantly among the investigators and laboratories.

Mobility is a temperature dependent quantity, frequently vary-

ing inversely as the T^x power, where x may vary from about 1.2 to 2.5. Mobilities also are reported at room temperature where possible, but in some of the lesser investigated materials, the temperature dependence is not known and the figures are proportionately less reliable.

The mobility reported is the highest mobility measured, but need not necessarily represent the true upper limit. Note the anomaly in AlSb where hole mobility is greater than electron mobility. Table I gives the impression that the compounds with the higher energy gaps in general have lower mobilities, but theoretically there

need not be a 1:1 correspondence between these two factors.

Lifetime τ in column 9 is in microseconds, also averaged. As the gaps in this column indicate, lifetime is least thoroughly investigated and understood among the principal parameters of semiconducting materials. Highest values obtained by any investigators consulted are reported.

Density in column 10 is in gm/cm³. Some of these values were obtained by investigators 20 years ago, when purification techniques were less developed than they are today.

Melting points in column 11 are in degrees C; remarks similar to

Table II—Characteristics of Organic Semiconducting Compounds (Mainly Dyes)

Name	Formula	E_A	E_g	ρ_i	μ_n	M.P.	Remarks
Cyanthron		0.1		1.2×10^7	10^{-8}		Also called indanthrene blue R, caledon blue R or durathrene blue
α - α -diphenyl- β -picryl hydrazil			0.26	1.6×10^6			
Indanthrene, black	$C_{28}H_{14}N_2O_4$	0.28				470p	Also called durathrene, caledon
Indanthrone	$C_{28}H_{14}N_2O_4$	0.32					Also called indanthrene blue
Indanthrazine		0.33			10^{-12}		
Flavanthron		0.35			10^{-7}		Also called indanthrene yellow G
Isoviolanthron	$C_{34}H_{16}O_2$	0.38			10^{-6}		Also called isodibenzanthrone (var.)
Violanthron	$C_{34}H_{16}O_2$	0.39	0.8	2.9×10^8			Dibenzanthrone; repr of stable polycyclic hydrocarbons
Isoviolanthrene		0.41			10^{-9}		
Pyranthron	$C_{30}H_{14}O_2$	0.53	1.08	3.7×10^6	10^{-9}		Also called indanthrene yellow-orange G
Pyranthrene		0.54					
Ovalene		0.56			10^{-8}		
m-Naphthodianthrene		0.60			10^{-11}		
m-Naphthodianthron		0.65			10^{-9}		
Isodibenzanthrone		0.75	0.96	50	10^{-5}	142	Also called indanthrene violet R or caledon purple R
Anthracene—single crys	$C_{14}H_{10}$	0.82	1.65		10^{-2}	216	Strongly fluorescent; monoclinic
Anthracene—powder	$C_{14}H_{10}$	0.83			10^{-4}		
Anthracene—film	$C_{14}H_{10}$	0.96			10^{-4}		
Naphtacene—film		0.82			10^{-3}		
Anthanthrene		0.84			10^{-7}		
Anthanthrone		0.85	1.7		10^{-6}		
Pantacene—film		0.86	1.72		10^{-2}		
Methylene blue	$C_{16}H_{18}N_3SCl \cdot 3H_2O$	0.92					$E_A = 1.6$ ev when ZnCl is added
Perylene—film	$C_{20}H_{12}$	0.97	1.94		10^{-2}		
Coronene	$C_{24}H_{12}$	1.15	2.3		10^{-3}	438	Monoclinic
Phthalocyanine (metal free)	$C_{32}H_{18}N_8$	1.2	2.4		1		Monoclinic
Cu—phthalocyanine		1.3	2		10		Monoclinic
5, 6N-pyridino-1, 9 benzanthrone		1.6	3.2		10^2		
Hydroviolanthrone		1.7	3.4		10^2		
Naphthalene, single crystal	$C_{10}H_8$	1.85	3.7	10^{-13}	10^{11}	80	Values for resistivity and mobility are in question

those made about E_g apply here also. The suffix letter p indicates that the substance sublimes and melting points given are obtained at some pressure greater than atmospheric.

The dielectric constant K in column 12 is a dimensionless number in the esu system.

The a or side-of-cube dimension in column 13 is in Angstroms.

Organic Compounds

Table II lists organic semiconducting compounds on which data is available. As indicated by the blank spaces, these are not even as well investigated as the inorganic compounds and the data must be considered tentative in view of the limited number of research teams who have contributed. Note the remark for single crystal naphthalene.

The list is indicative of still another unexplored area of the semiconducting compounds from which fruitful results may be forthcoming; from the literature consulted, practical transistors or diodes have not been made from these, even on a laboratory basis.

The activation energy in ev, given in the E_a column, is defined as the minimum energy for the interchange of two atoms of a substance; it may or may not be directly related to the energy gap in all substances. If the impurity atom is located at an energy level half way into the forbidden gap, then the energy gap will be numerically twice the activation energy.

General Comments

When a mixture of elements which results in a compound contains atomic proportions accurately represented by the formula, the compound is said to have stoichiometric proportions; when the proportions indicate an excess or deficiency in any constituent, the material is nonstoichiometric. A useful property of semiconducting compounds is that an excess of one of the elements may produce an n or p -type substance; for example

Substance	n if excess	p if excess
PbS	Pb	S
CdTe	Cd	Te

For Si and Ge, doping agents are taken from the third or fifth col-

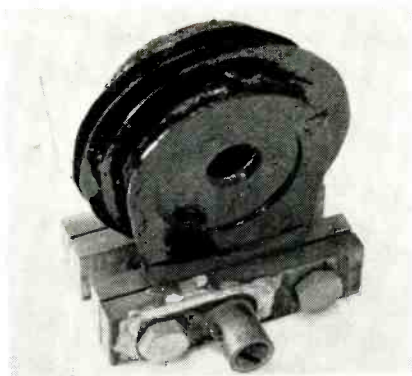

Peltier effect cooling unit constructed of Bi_2Te_3 produces 40 C temperature difference with 13-w input

umn of the periodic table; similarly, doping agents for the semiconducting compounds are taken from the appropriate columns of the periodic table. For instance, for CdTe elements from the third and seventh columns yield n -type material; from the first and fourth columns, p -type material. Now the doping agents come from four columns instead of two; when this is combined with the stoichiometric excess noted, it is evident that a truly inviting flexibility exists for the compounds.

Though compounds of a form such as $\text{A}^{\text{IV}}\text{B}^{\text{IV}}$ may result in semiconductor material, for example Mg_2Sn , Mg_2Si , Mg_2Ge , they need not produce semiconductors— Mg_2P is a conductor. Thus the problem of producing semiconducting compounds must be approached on a one-by-one basis, with each product investigated over an extensive temperature range while examining for characteristics of the semiconductors.

Shortcomings

No commercial transistors or diodes are available made of semiconducting compounds. The known shortcomings of many of these compounds militate against their more general use. For example, many of the compounds exhibit a change in type, from n to p or vice versa, over a useful temperature range. At 90K, n -type InSb turns to p type; Te and TeSe alloys exhibit a double reversal in the range from 20C to 200C, Te will become n type at 20C and revert to p type at 200C. For CdTe, irreversible changes occur at about 150C and the material turns to n type; above 300C, the type

changes irreversibly to p .

The changes in such cases are not necessarily abrupt, a gradual change of characteristics being noted as the temperatures are reached or passed. There are many such illustrations, the effect being due in many cases to separation or evaporation of one of the constituents at critical temperatures. This is particularly noticeable in the excess semiconductors when the excess element tends to sublime or, as in the case of Te just noted, changes type when it is the excess element.

In some materials transistor action is observed only at low temperatures; for PbSe this is in the neighborhood of 90K. Some of the compounds (AlSb, CdS, Mg_2Sn) are unstable in air, particularly if high in humidity; some (GaSb) are particularly difficult to purify. In many, the rectification effect is not good enough for commercial application. Either the ratio of reverse-to-forward resistance is too low or the piv too small; in still others, transistor action is almost entirely absent.

Desirable Characteristics

The specifications of characteristics for the materials to make good transistors and diodes are long and difficult to fulfill. Salient features are that the material should be easily and economically available, should be unconditionally stable in moist as well as dry air, have a reasonably high melting point, show a dielectric constant of at least 10 from bond strength considerations and temperature variation, have an energy gap in the range possibly from 1.5 to 4 ev, have principally covalent bonding without an ionic component so large that the accompanying dielectric constant is too small, show reasonable piv and rectification ratio and show good transistor action in regard to carrier injection problems over the useful temperature range.

The author thanks Battelle Memorial Institute, General Electric Co., Bell Telephone Laboratories, Clevite Corporation and Ohio Semiconductors, Inc. for their kind assistance in furnishing the photographs of the materials and apparatus.

Thyratrons Improve

By W. ORNSTEIN

Supervisory Engineer
Canadian Marconi Co.

SUMMARY — Cold-cathode trigger tubes in sequential counter circuits supplant “watchmaker’s nightmare” in vehicular radiotelephone system. Five-digit code of integers from 2 to 10 permits up to 59,049 subscriber phones on single channel. Interchange between two audio tones, 600 and 1,500 cps, occurs for each unit of digit dialed. Readout circuit energizes buzzer at receiver for 4 seconds, then lights indicator lamp if call is not answered. Unit is smaller and less expensive than electromechanical selector used for the same purpose

LAND MOBILE RADIO communication systems handle the bulk of their traffic between a fixed central station and a number of vehicular installations. In systems operated by common carriers a central-station transmission destined to a particular subscriber should operate only the handset receiver or loudspeaker in the vehicle of that subscriber.

Most methods of selective calling use a signal of audio tones generated by a coder unit at the central station to modulate the carrier. A different code signal is employed for each subscriber in the system. When the selector unit in the mobile receiver responds to a given code, a readout circuit functions and the subscriber is given an aural or visual indication that he has been called.

Electronic Selector

The novel aspect of the present design lies in the functions previously performed by electromechanical devices which are here achieved by electronic circuitry. This results in a mobile selector of appreciably lower cost and smaller size than other current designs. A block diagram of the complete system including the coder is shown in Fig. 1.

The selective call is made by the central station operator as follows:

(a) Press the CALL button on the coder control unit and pause until the WAIT lamp lights in 0.6 sec.

(b) Dial the five-digit code on the standard telephone dial associated with the coder control unit. Each digit has a value from 2 to 10 and their sum is normally 23 or 25. Digit 0 corresponds to 10 and digit

1 is used only as a clearing signal to restore all selectors to their rest positions.

The code signal comprises two audio tones, 600 and 1,500 cps. One of these tones is always present when a code is transmitted. The selector unit operates mainly as the result of a frequency interchange in the code signal received. The interchange would be either from 600 to 1,500 cps or from 1,500 to 600 cps. When the CALL button on the coder is operated, the carrier is turned on with 600-cps modulation. After 600 millisecc the WAIT lamp goes on, indicating that the operator can proceed to dial, and a tone interchange to 1,500 cps occurs. The 600-cps interval and the initial tone interchange insure that all selectors in the system are restored to their rest position before the code is transmitted.

Final Interchange

The dialing of any digit causes a corresponding number of tone interchanges. Since the sum of the digits is odd, a final interchange always goes to 600 cps. This causes a bell to ring in the desired subscriber’s installation. Four seconds after the completion of dialing there is a final interchange to 1,500 cps after which the tone

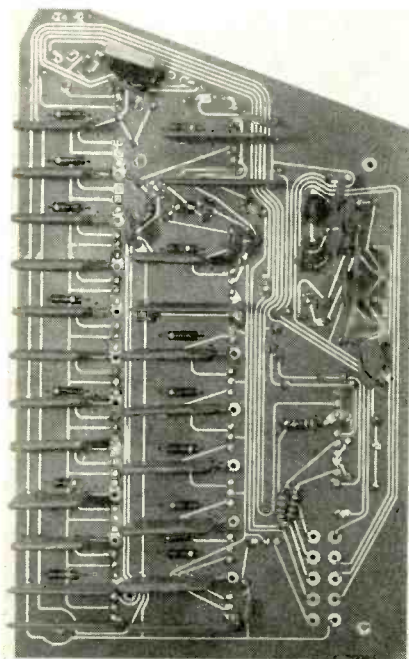

Printed wiring on inner side of board

Mobile Phone Operation

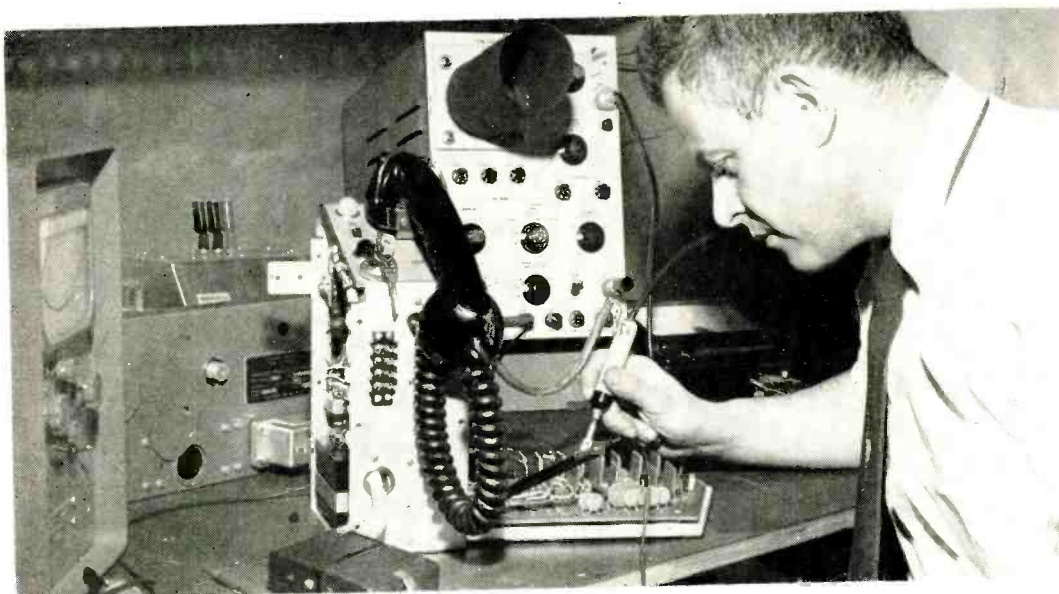

Selector circuits are enclosed in unitary assembly of telephone. Drop-leaf construction permits ready access

modulation ceases and the carrier is turned off. The final interchange of tone silences the subscriber's bell if he has not yet answered and a lamp signal is substituted. Also all selectors in the system, including that of the subscriber just called, are reset to rest position.

Tone sequence for the code number 4-3 is shown in Fig. 2. This two-digit code has been used for simplicity of illustration, but a more typical code might be 3-3-10-2-5, a five-digit group adding up to 23. Although the dialing pulses for a given digit are shown as 100 millisecc while the interval between digits is shown as 500 millisecc, these are nominal values. For design purposes it is assumed that dialing pulses occur at a rate between 8 and 11 per sec while the interdigit interval is a minimum of 500 millisecc. The number of digits can be anything from one to five and each digit can have any value from two to ten. The possible number of five-digit codes is therefore 9^5 or 59,049.

Thyratron Counters

The design of the selector is based on the use of cold-cathode thyratrons in sequential counter circuits. Like the hot-cathode thyratron, the cold-cathode variety is

essentially an on-off device in which the trigger loses control as soon as the main discharge between anode and cathode has been established. Control is regained only when the glow discharge is extinguished by reducing the anode voltage below the maintaining value.

The Hivac XC18 tube employed in this design has the following characteristics:

- (1) Control gap breakdown voltage 62 to 74 v.
- (2) Main gap maintaining voltage 68 to 74 v.
- (3) Minimum main gap breakdown voltage 200 v.

These figures are based on some ambient illumination of the tubes providing an initial ion source to initiate the discharge. In the selector this is provided by a miniature NE2 neon bulb mounted between each pair of trigger tubes.

The decade counter circuit of Fig. 3 consists of a zero tube and ten counter tubes. Readout terminals are connected to the cathodes of counters 2 to 10 inclusive. There is a common plate load for all tubes and a common counting pulse line for all but the zero tube. The trigger electrode of each counter tube is coupled capacitively to the common pulse line and resistively to the cathode resistor tap

of the preceding stage. The trigger electrode of tube zero has a fixed positive bias of 45 v. The anode supply is regulated at 180 v which is 20 v below the 200-v minimum striking voltage but well above the 70-v maintaining voltage.

Counter Operation

Assume that all eleven tubes in the counter are initially extinguished. When plate voltage is applied to the selector a 4-v pulse is applied to the trigger of tube 0 by the reset circuit. This tube fires and its current develops a cathode voltage of 90 v. This applies 50 v to the trigger of tube 1, which is the normal initial condition for this counter.

When a digit is dialed at the coder unit the input of the selector generates a 2-millisecc positive pulse with an amplitude of 50 v for each interchange of tones received. Thus dialing the digit 2 would generate two positive pulses, each of 2 millisecc duration and spaced 100 millisecc apart. These pulses appear on the trigger electrodes of tubes 1 to 10. In the case of all but tube 1 the pulse amplitude is insufficient to fire the tube to which it is applied. But tube 1, due to its 50-v priming voltage, will fire.

When this tube fires it reduces

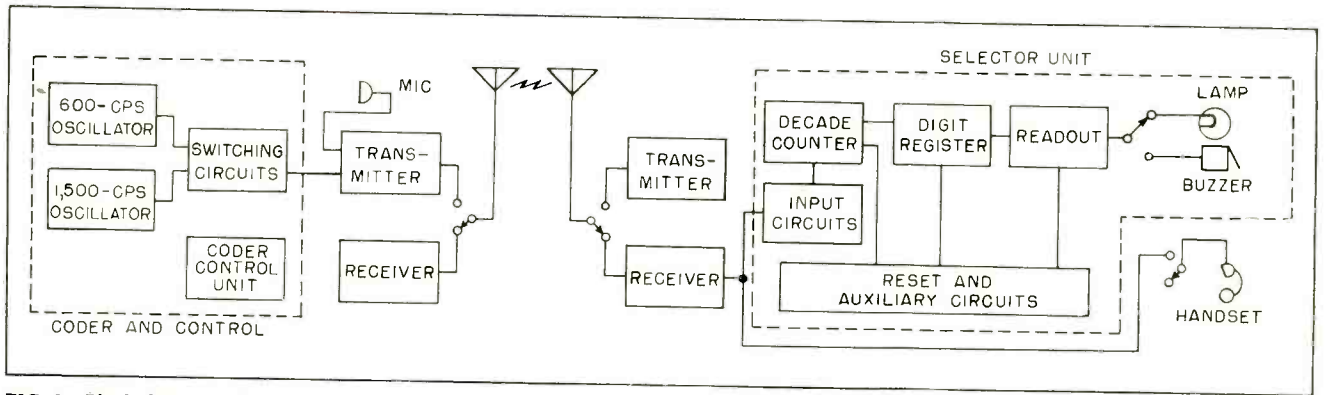

FIG. 1—Block diagram of two-way mobile telephone system. Central-station equipment is shown left, vehicle unit at right

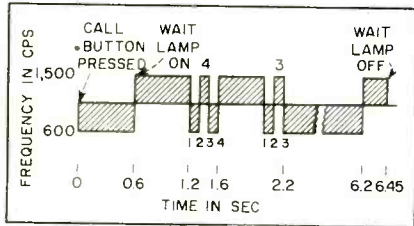

FIG. 2—Tone sequence for code signal 4-3

the voltage to ground from the common anode line to its own maintaining voltage of 70 v. This is because at the instant of firing there is no voltage across its cathode resistor due to the time required for a voltage rise across its cathode capacitor. Tube 0, however, will have 90 v from cathode to ground due to the charge on its cathode capacitor. Tube 0 is therefore extinguished since the voltage across it is less than the maintaining voltage and the discharge is transferred to tube 1. The cathode capacitor of tube 1 will charge up to nearly 90 v in considerably less time than the 100-millisecond interval between pulses, thus restoring the anode line to its original value of 160 v and also priming the trigger of tube 2 with 50 v. When the second pulse arrives an identical sequence of events causes the discharge to transfer from tube 1 to tube 2.

To summarize, in the initial condition prior to dialing a digit tube 0 in the counter is on and all other tubes are off. On dialing a given digit the discharge transfers to the corresponding tube in the counter and a readout voltage appears on the cathode of that tube.

The circuit time constants are chosen so that the voltage rise at the anode line immediately after a tube is fired occurs slowly com-

pared with the deionization of the tube just extinguished. But nearly full priming voltage to the next counter stage must exist before another pulse arrives. For the slow counting rate of ten pulses per sec required in this application time constant presents no problem, but the upper limit of the counting rate depends upon the deionization time of the particular tubes used.

The input circuit shown in Fig. 4 converts the sequence of tone interchanges received from the coder unit to a sequence of pulses having the desired polarity, amplitude and duration to operate the decade counter and auxiliary circuits of the selector. This circuit has high immunity against false triggering of the counter by noise, and output pulses whose amplitude is independent of the code signal level.

Selector Input

The input transformer matches source impedances of 3.2, 50 and 500 ohms. Shunted across the secondary are two series-tuned circuits with a loaded Q of 10. The first circuit is resonant at 600 cps, the second at 1,500 cps. Adjust-

ment of the series capacitors compensates for errors up to ten percent in the code signal frequencies.

Across the inductance of each tuned circuit is a rectifier-filter comprising two voltage doublers and a clamping diode. A 45-v bias is obtained through a voltage divider from the 180-v line. All rectifier outputs are referred to this bias.

Voltage doublers connected to a given inductance produce a positive and a negative voltage respectively. The positive output of the 600-cps inductance connects to the negative output of the 1,500-cps inductance at the junction of the 5.6 and 2-meg resistors. This junction connects to the bias line through a clamping diode and to the trigger of the 600-cps input thyatron. This trigger can thus become more positive than 45 v but cannot go below this value due to the clamping diode. Similarly the trigger of the 1,500-cps thyatron receives positive voltage from the 1,500-cps inductance and negative voltage from the 600-cps inductance, and it is also clamped to a lower limit of 45 v.

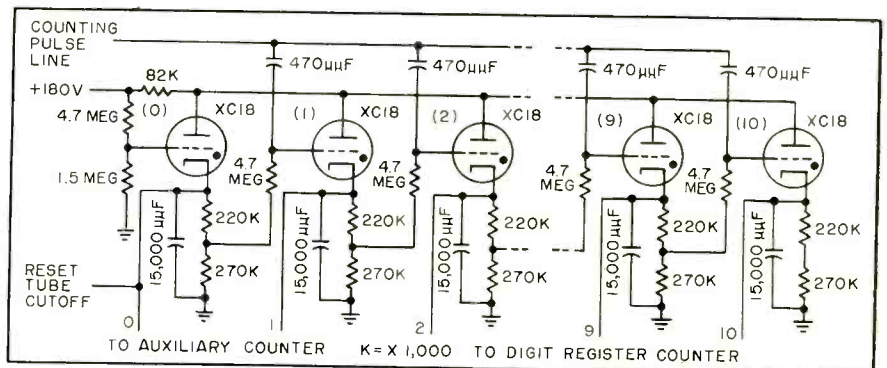

FIG. 3—Decade counter initially has tube 0 on and all other tubes off. Dialing transfers charge from tube 0 to corresponding counter stage

Consider the effect of a pure tone of 600 cps at an input level of at least 100 mw. Assume that both input tubes are initially in an off condition. A positive voltage will be produced at the trigger of the 600-cps tube sufficient to fire it. This results in an initial positive current pulse in the common cathode circuit due to the discharge of the capacitor at the plate of the fired tube. This pulse has a steep leading edge dying down exponentially nearly to the steady-state cathode potential of 10 v in 2 millisecond. The shape and amplitude of this output pulse is independent of the amplitude of the triggering voltage which causes it.

If the 1,500-cps tube is already on, when the 600-cps tube is triggered, the cathode voltage of the 1,500-cps tube will also rise due to the common cathode connection. Its anode voltage is held at 80 v, however, due to the time required to charge its plate capacitor to an appreciably higher value. The voltage across the 1,500-cps tube therefore drops instantaneously below its maintaining value and the tube extinguishes. The voltage remains below the maintaining value longer than the deionization time and the tube remains extinguished. If the 600-cps tone is applied when the 600-cps tube is already on, there will of course be no output pulse from the common cathode circuit. The application of a 1,500-cps tone has identical results to those just mentioned if reference in the foregoing description is made to the 1,500-cps tube in place of the 600-cps tube.

Consider now the effect of a band of noise frequencies having

both 600 and 1,500-cps components. This would result in a combination of positive and negative voltages at both input tube triggers. If the noise powers at the two frequencies were of about the same magnitude, as would be likely in practice, the resultant voltage would not be sufficient to trigger either input tube. The complexity of the code makes false triggering due to noise alone or even noise combined with another code signal practically impossible. The input circuit gives a pulse output for every tone interchange between 600 and 1,500 cps. There is one output across the full cathode resistor for the decade counter reset circuit, and another across a tap in the cathode resistor for the pulse counting line of the decade counter.

Counter Reset

The decade counter reset circuit shown in Fig. 5 resets this counter to tube 0 350 millisecond after the completion of dialing each digit of the code. Since the interval between digits is at least 500 millisecond this insures that the counter will be reset prior to the dialing of each digit.

Assume that supply voltage has just been applied to the counter and all its tubes are initially extinguished. The reset diode will fire and charge the large capacitor connected to its anode. The resulting pulse at its cathode is superimposed on the steady priming bias to fire tube 0. This firing in turn results in a 0-tube cathode voltage of 90 v. Since the reset diode is returned to ground through the cathode of tube zero, the diode voltage falls below maintaining value

and it consequently extinguishes.

If counting pulses are now applied to the decade counter, tube 0 is extinguished, its cathode voltage drops to zero and the disabling bias is removed from the cathode of the reset diode. The reset tube would immediately supply another triggering pulse to tube 0, resetting the counter as soon as it had counted one, if it were not for the reset inhibitor tube.

The reset inhibitor receives a triggering pulse every time a counting pulse is supplied to the decade counter. Since its plate resistor will not pass enough current to sustain its discharge, the inhibitor tube remains fired only as a result of the charge on its plate capacitor. This ceases when the potential at the tube end of the plate capacitor declines below the 70-v maintaining voltage of the inhibitor tube. The voltage across the capacitor is now 110 v and it proceeds to discharge through the plate load. Each time a new pulse is generated at the input, however, the reset inhibitor fires, the voltage across the capacitor again rises to 110 v and the discharging cycle begins anew. When the last pulse is generated for a given digit, 350 millisecond later the reset diode plate capacitor discharges sufficiently to raise the diode potential to its ignition value, resulting in a triggering pulse to tube 0 which resets the decade counter.

Digit and Auxiliary Counters

In the rest condition of the selector, prior to receiving the five digits of a code signal, tube 0 of the digit register counter shown in Fig. 6 is fired and the other six

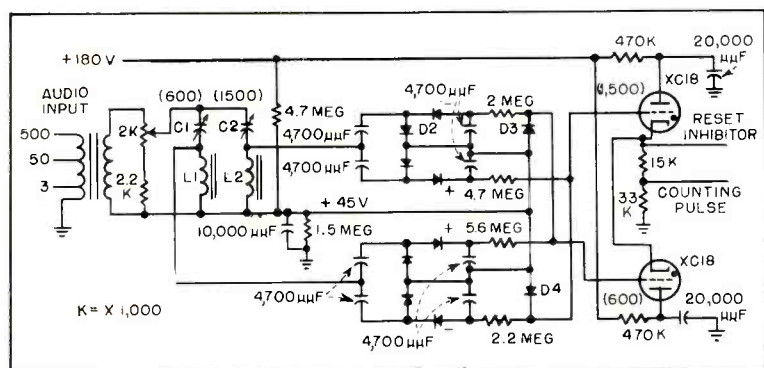

FIG. 4—Selector input circuit converts tone changes to pulse sequence to operate the decade counter and auxiliary circuits of the selector

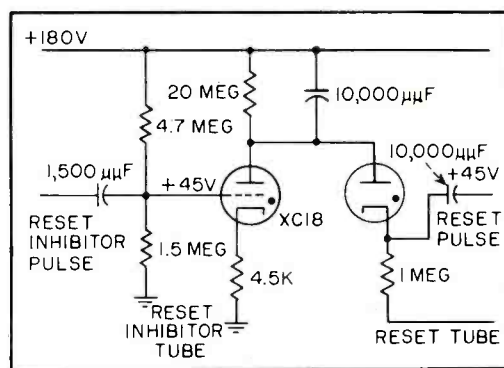

FIG. 5—Reset circuit restores decade counter to zero after end of dialing of each digit

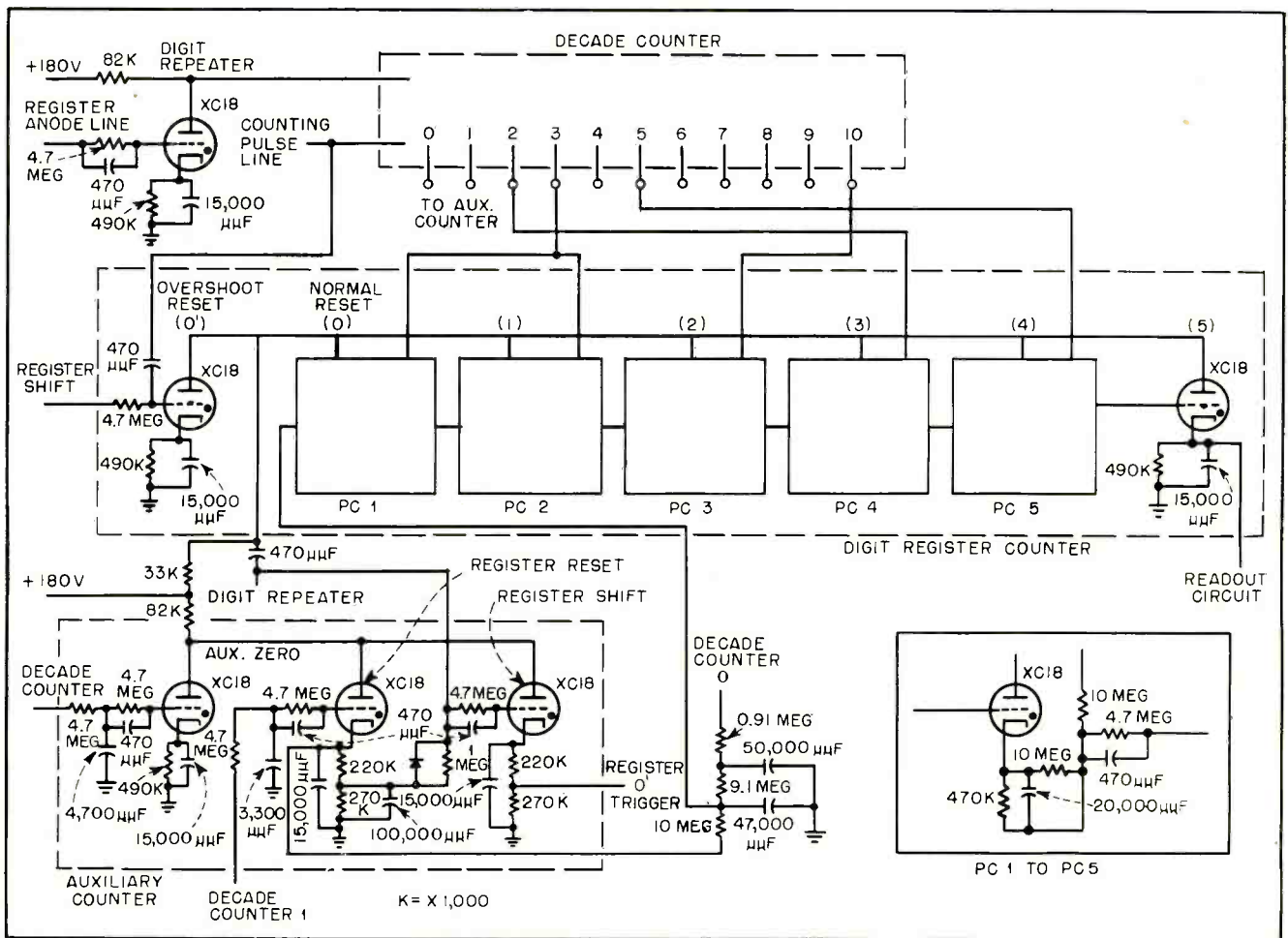

FIG. 6—Digit register tube inputs are connected to decade counter cathodes corresponding to desired code. Connection here is 3-3-10-2-5

tubes are extinguished. If the digit register were in any other condition it could always be reset to this rest condition by dialing 1 or by the single tone interchange which always precedes a code signal.

Time Constants

Except for the 0' stage the tubes of the digit register and auxiliary counters have fairly large time constants in their trigger circuits. This is desirable because, unlike the tubes of the decade counter which are triggered by 2-millisecond pulses, these tubes are triggered by voltages of 100 millisecond or longer. Large time constants also insure against false triggering due to accidental transients.

Consider the selector 350 millisecond or more after the receipt of its last dialing pulse. Decade counter tube 0 will have fired due to the action of the reset diode. Auxiliary tube 0 has its trigger connected through a 20-millisecond R-C circuit to the cathode of decade counter tube 0,

and auxiliary tube 0 will therefore fire about 20 millisecond after the decade counter resets.

On dialing 1 the decade counter will step up one thereby removing voltage from the trigger of auxiliary tube 0. Voltage is applied to the trigger of the register reset tube which is connected via an R-C circuit to the cathode of tube 1 of the decade counter. The auxiliary counter will then step up one, extinguishing auxiliary tube 0 and firing the register reset tube.

The trigger of digit register tube 0 is connected to a coincidence circuit comprising two resistors, one terminating at the cathode of the register reset tube, the other at the cathode of decade counter tube 0. When both of these tubes are fired their cathodes are at 90 v, as is the trigger of digit register tube 0, which fires and resets the digit register. If only one of the tubes is fired the cathode of the other is at ground potential. Only 45 v then appears at the trig-

ger of digit register tube 0 which is insufficient to fire it.

When 1 is dialed the register reset tube fires. When the decade counter resets its tube 0 fires. But for approximately 20 millisecond the auxiliary counter has both decade counter tube 0 and the register reset tube on. Thus dialing 1 and allowing the decade counter to reset also resets the digit register.

The selector responds to a given code when trigger inputs of register tubes 1 to 5 are connected to the cathode terminals of the decade counter corresponding to the code digits. In Fig. 6 this set of connections has been made for a code of 3-3-10-2-5.

Digit Register

Assume that the digit register is in its zero reset condition and that some digit greater than one is dialed. There are three possibilities: the dialed digit is either less than, the same as, or greater than the first digit of the desired

code. In the first case no triggering pulses are received by tube 1 of the digit register and its rest condition is not disturbed.

In the second case the first tube of the digit register is fired and tube 0 is extinguished in a manner similar to the counting sequence in the decade counter. Priming voltage is removed from the trigger of digit register tube 1 and applied to tube 2. Moreover when the decade counter resets the voltage derived from it and previously applied to the trigger of digit register tube 1 disappears.

When the digit register counts from zero to one a voltage pulse appears at its anode line. A capacitor coupled to the anode line differentiates the pulse and feeds it to the triggers of the register shift and digit repeater tubes.

The differentiated pulse consists of two narrow spikes, the first negative and the second positive. The negative pulse is bypassed to ground by the clamping diode while the positive pulse serves to trigger both the register shift and digit repeater tubes.

The transfer of the discharge in the auxiliary counter from the register reset to the register shift prevents the digit register from being reset by the coincidence circuit at the trigger of its tube 0 when a desired digit has been counted.

Double Counting

Consider the case where two consecutive tubes in the digit register are connected to the same readout point on the decade counter, when two consecutive digits of a code signal are the same. If the decade counter were not reset for 350 millisecc after counting up to the first of the two identical consecutive digits, two stages of the digit register would be fired by the given digit instead of one.

But once the digit register has been stepped up by the desired digit, the pulse in its common anode line resets the decade counter to the digit repeater quickly enough to prevent the double count from occurring. This is due to the time constant in the trigger circuits of the digit register being much longer than the time constant in

the trigger of the digit repeater. The firing of the digit repeater does not prevent the digit counter from resetting to its tube 0 in the normal way 350 millisecc after the dialing of the last pulse of the particular digit just received.

Consider now the third case where the dialed digit is larger than the desired digit for which the first digit register tube has been set up. This is taken care of by tube 0' in the digit register. When the register shift tube fires as a result of a count by the digit register it primes tube 0'. The trigger of this tube is connected by a capacitor to the counting pulse line of the decade counter. If any subsequent pulses are received by the decade counter tube 0' will fire. This resets the digit register to the 0' position and no permanent count

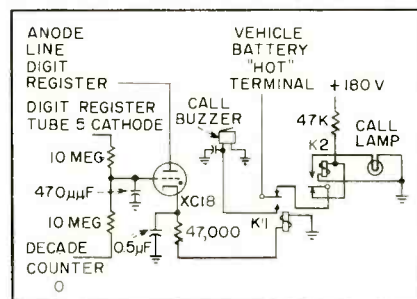

FIG. 7—Readout circuit energizes buzzer and then lamp to indicate incoming call

can be recorded by it. Once tube 0' has fired it is impossible to fire subsequently any other tubes in the digit register except tube 0.

If a digit either equal to or greater than the desired digit is dialed and the register shift tube is therefore fired, the resetting of the decade counter to its zero position will also reset the auxiliary counter to zero thereby extinguishing the register shift tube.

Dialing a digit equal to that to which register tube 1 is set up will step up the register from 0 to 1. If a second digit is then dialed equal to that for which the second tube in the register is set up, the digit register will step up to 2. But if the digit dialed is either less than or greater than that for which tube 2 is set up, the effect will be the same as already described for dialing an incorrect digit. If the five digits of a received code signal

are those for which the selector has been set up, then the counter tubes of the digit register will fire in sequence and 90 v will appear across the cathode resistor of tube 5 of the digit register.

Readout Circuit

The readout tube shown in Fig. 7 has its trigger connected to a coincidence circuit of two resistors which return respectively to the cathodes of digit register tube 5 and tube 0 of the decade counter. When the decade counter resets after counting the last digit of a code signal for which the selector has been set up 90 v appears at both of these cathodes. This voltage also appears at the trigger of the readout tube causing it to fire. This operates relay K1 which in turn actuates the CALL buzzer and energizes relay K2.

After the completion of a code signal a clearing pulse consisting of a single tone interchange is received 4 sec later by the selector. This resets the digit register and thereby extinguishes the readout tube. Relay K1 now opens to silence the call buzzer while a holding contact on relay K2 keeps it closed. This combination has the effect of lighting the CALL lamp which remains lit after the readout tube extinguishes.

The handset mounted on the front panel of the selector is held in a retainer which operates a hook switch. One set of contacts on this switch disconnects the audio from the handset while it is held in the retainer. Another set connects the high-voltage supply to the selector while the handset is in the retainer and disconnects the supply voltage when the handset is removed. Since the CALL lamp relay operates from the high-voltage supply, removing the handset immediately extinguishes the CALL lamp as well as any fired thyatrons.

The writer acknowledges the work of Mr. T. A. Watson who was responsible for basic development of both the coder and selector.

BIBLIOGRAPHY

- J. R. Pollard, Selective Calling for Radio-Telephone Systems, *Electronic Engineering*, Dec. 1953.
- J. E. Flood and J. B. Warman, The Design of Cold-Cathode Valve Circuits, Parts I and II, *Electronic Engineering*, Oct. and Nov. 1956.



Recording unit handles microphone, phono and self-contained control-tone generators

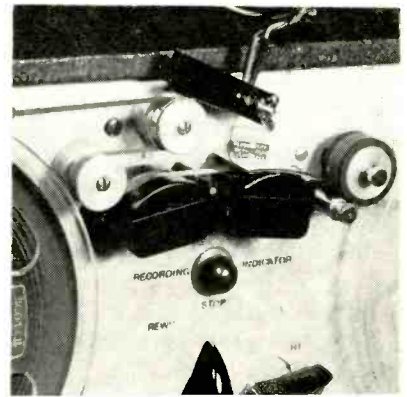

Auxiliary switch stops machine on cue

SUMMARY — Two-hundred selection changer for 45-rpm records plus a 3.75-ips tape system are the heart of an automatic programming arrangement. Complex sub-audible or modulated-carrier control signals are avoided by dual-track recording with announcements and control tones on separate tracks. During playback the changer is automatically energized by the control tone following an announcement, is tripped when music ends before entering the leadout spiral, then cues up next record

Jukebox and Tape

By JOHN K. BIRCH

*Project Engineer
Gates Radio Company
Quincy, Illinois*

AN AUTOMATIC BROADCASTING system must be able to take over the major part of the program activity while making the least demand on operating personnel and external equipment. If it can handle spot announcements, records and tapes in a flexible manner with minimum time consumed in the makeup process, its full potential for profitable use will be realized.

The system to be described, dubbed Auto-station, was conceived as a complete package requiring only a few external connections to fully automate broadcasting.

Flexibility is achieved by recording announcements and control tones on separate tracks. For operation of a record changer and two auxiliary circuits, such as portable tape machines, three control tones

of 290, 700 and 1,300 cps are produced by highly stable phase-shift oscillators.

Makeup Process

The recording unit is self-contained and includes a control console and a solenoid-operated tape machine. The tape operates at 3 $\frac{3}{4}$ ips with reels up to 14 in. and is shock mounted in a totally-enclosed soundproof cubicle. By manipulating front panel controls an announcer can mix microphone and turntable inputs, start and stop the recorder and apply an automatically-timed tone at the end of each announcement. He also can check the tape audibly by means of the small panel-mounted loud speaker and two switches which run the tape machine forward or backward

at normal-operating tape speed.

Operation of the unit may be understood by reference to the simplified schematic in Fig. 1. The mixing system is conventional, and uses the interstage volume control of the recording amplifier as a master control. The flexibility of the system is largely due to the 5-position RECORD-EDIT switch S_1 . In the RECORD position the mixing bus is connected to the record amplifier input. The output of this amplifier is connected to the announce record head, the vu meter and the headphones. The tone oscillator bus is connected to the tone record head and the d-c circuit is completed to the coil of record relay K_1 .

In the EDIT position the heads are tied in parallel and connected to the

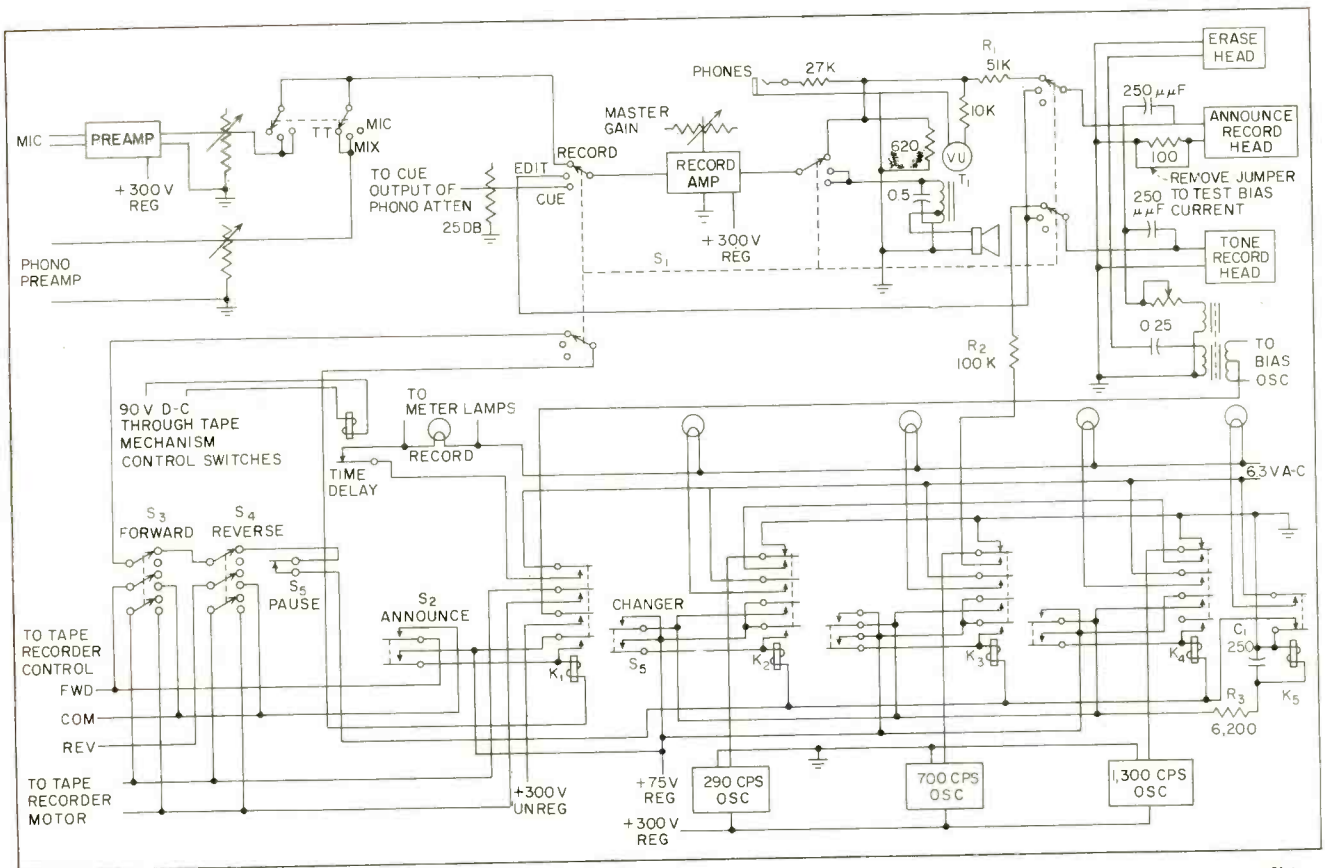

FIG. 1—Simplified schematic of audio and control circuits of Autostation recording unit includes playback for monitoring and editing

Automate Radio Shows

input of the record amplifier, whose output feeds the front panel loud speaker. The K_1 coil circuit is broken to prevent accidental recording when editing. In the CUE position, the cue output of the turntable attenuator is fed to the record amplifier input. Excessive highs due to amplifier equalization are rolled off by a capacitor across T_1 .

The recording heads are of the high-impedance type, and a constant current source is provided by resistors R_1 and R_2 . Since the erase head is low impedance two secondaries must be used on the bias oscillator transformer to obtain the correct currents.

Recorder Operation

When ANNOUNCE switch S_2 is depressed relay K_1 closes and ener-

gizes the tape recorder motor and solenoid, applies bias oscillator plate voltage, and illuminates the vu meter and record lamps. This last circuit is completed through a time-delay relay in the tape mechanism, which opens at the instant K_1 closes, but closes 0.5 sec later. The slight delay in lighting the panel lamps cautions the announcer to wait for the machine to stabilize before talking.

The ground return for the coil of K_1 is interlocked through the edit switches S_3 and S_4 and the mode selector switch S_1 to make it impossible to erase the tape accidentally while editing. It is also carried through PAUSE switch S_5 which provides a means of interrupting the recording when necessary.

The upper set of contacts on S_2

energizes the forward-direction contactor in the tape mechanism in the event that the machine has been left in the reverse-direction mode. The FORWARD and REVERSE edit switches S_3 and S_4 energize the respective direction contactor and the motor simultaneously.

Basic Oscillators

The three oscillators whose basic circuit is shown in Fig. 2 are running continuously, but have their outputs grounded to prevent crosstalk. They are selected by relays K_2 , K_3 and K_4 when the associated pushbutton switches are depressed. When S_5 is depressed, for example, the lower set of contacts energizes K_2 , which holds in when the button is released. The upper set of contacts of K_2 connects the oscillator to



Playback unit may be remotely operated from control console with other sources



Remote control unit for use at console

the record head. The second set illuminates a lamp adjacent to the switch. The third set applies voltage to relay K_5 , which closes in about two seconds due to the action of R_3 and C_1 .

When K_5 closes, it releases K_2 by breaking the ground return. Thus a 2-sec tone has been recorded on the tape. Since the ground return also serves K_1 , this relay opens and shuts off the tape motor and bias oscillator. The upper set of contacts on S_5 prevents the continuous cycling of K_2 and K_5 in the event that the switch is held down longer

than two seconds. Operation of the other two tone circuits is identical.

The playback tape machine is identical to the recording mechanism except for the absence of the bias oscillator and erase head. Mounted in the same cabinet are a 200-side jukebox-type record changer, an automatic-gain program amplifier and a monitor amplifier, along with two relay control chassis.

Changer Control

The changer mechanism is not modified but the preamplifier-con-

trol unit is replaced with a broadcast-type phonograph preamplifier and a separate relay control system.

The control system shown in Fig. 3 starts the changer when energized by the 290-cps tone, trips the changer when the music ends and causes the changer to cue up the next record and then stop.

The basic circuit for the selective amplifiers is shown in Fig. 4. The relays associated with these amplifiers are normally de-energized with no signal. When a 290-cps tone appears on the tape K_6 will close for the 2-sec duration of the

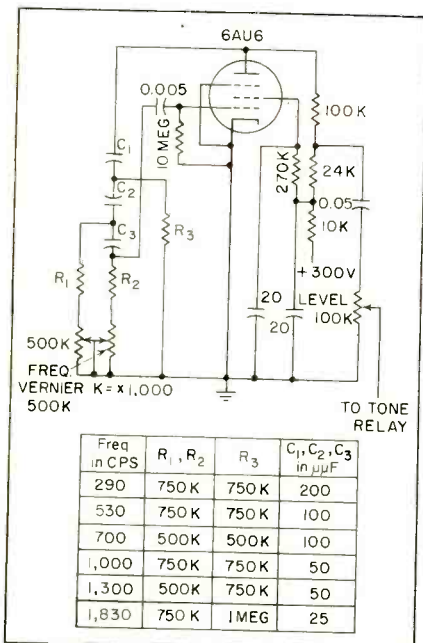

FIG. 2—Basic circuit of tone oscillators

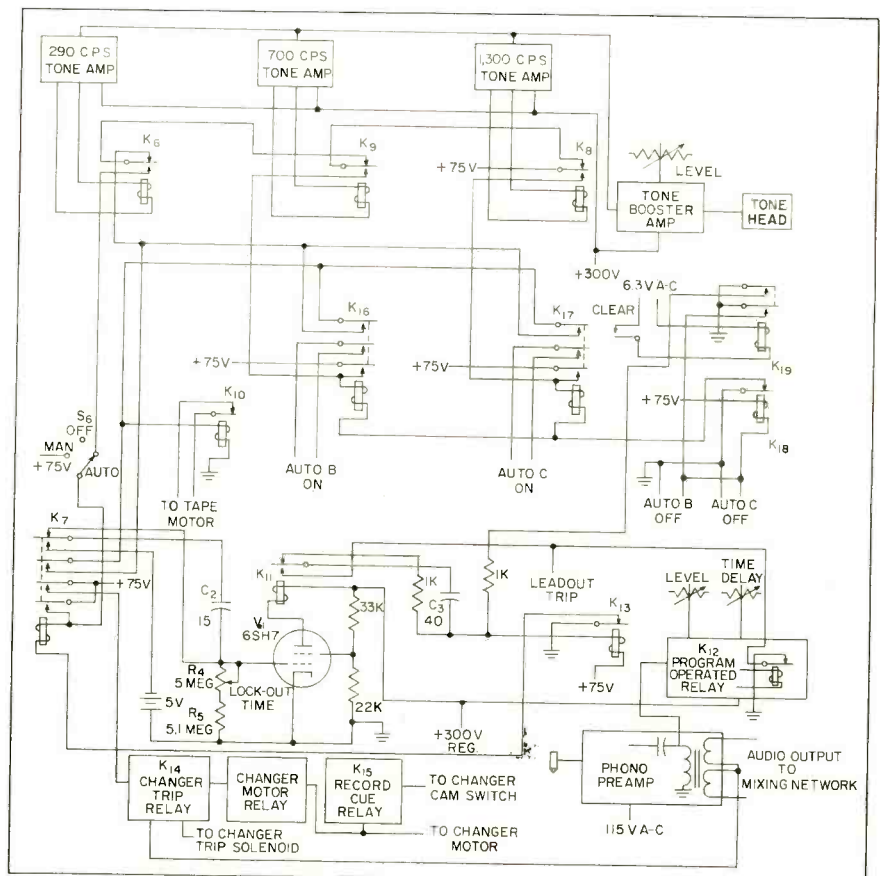

FIG. 3—Simplified schematic of audio and control circuits of playback unit

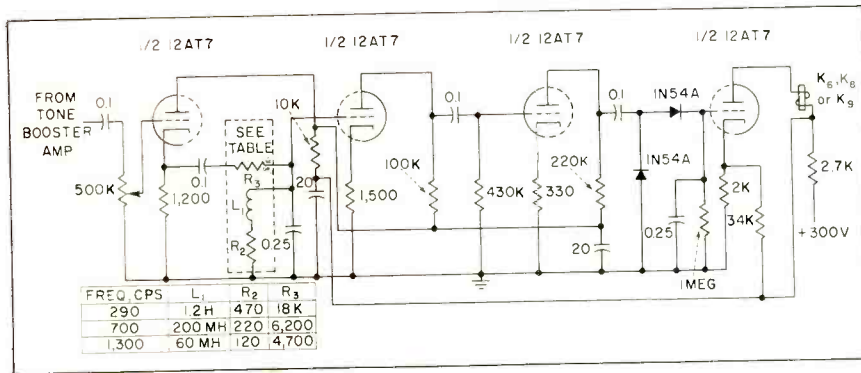

FIG. 4—Basic schematic of the three selective control-tone amplifier circuits

tone. When it closes K_7 will close and lock in, starting the changer. At the end of the tone K_8 releases and its back contacts make a circuit from the 75-v d-c supply through the back contacts of K_8 , K_9 , through closed contacts of K_7 to the coil of K_{10} . At this point K_{10} closes and turns off the tape machine.

Program Trips Changer

It is not desirable to let the record leadout groove trip the changer due to the lengthy time required with some records. Consequently a program-operated relay K_{12} has been incorporated to trip after a predetermined length of time following the end of the music. As shown in Fig. 3, this circuit is fed from the output of the phonograph preamplifier, and with no signal the relay is closed.

Lock-out

To prevent the changer from triggering due to a long pause in the record, a lock-out circuit is included to disconnect the program-operated relay during a period of time while the record is playing. This is adjustable from 1½ to 3 min, a common setting is 1 min, 45 sec.

This lock-out circuit is set up by K_7 . When it closes to start the changer, one set of contacts applies -5 v to the grid of a relay tube V_3 , cutting it off and releasing K_{11} . As long as K_{11} is open, there is no circuit to program-operated relay K_{12} . However capacitor C_2 begins to charge through R_4 and R_5 , and after a time determined by R_5 the grid voltage is reduced to a point where the tube conducts and K_{11} closes. Now when K_{12} closes after a pause of about 1.5 sec in the music, ground is applied through the contacts of K_{11} to K_{13} , which

closes and releases relay K_7 .

The purpose of C_3 is to provide a momentary pulse to K_{13} , since it must not remain energized. Both C_2 and C_3 discharge when their respective relays are released. When K_7 releases, K_{14} trips the changer mechanism, and K_{15} disconnects the changer motor after the arm drops on the next record. K_{14} also mutes the preamplifier during the change cycle. To insure that the changer trips in the event that K_{12} does not function (a situation which could result from a noisy record, for example) the leadout trip circuit of the changer mechanism is paralleled with K_{12} .

Control panel switch S_6 , which is locking in the automatic position and non-locking in the manual position, allows manual operation of the changer for testing purposes.

The auxiliary functions, designated as AUTO B on-and-off and AUTO C on-and-off, are intended for the control of external tape playback machines. With the on terminals connected in series with the common a-c lead to the tape motor, a 700 or 1,300-cps tone on the control tape will energize K_{16} or K_{17} and start the auxiliary machine.

Machine Shutdown

To stop the machine it is necessary to energize K_{18} . This is accomplished by attaching to the front panel of the auxiliary machine a cutoff switch block having two light spring-wire fingers which make contact with the back surface of the magnetic tape. A short piece of ¼-in. wide adhesive aluminum tape is attached to the tape backing at the end of the program segment and the short circuit thus provided applies a ground to K_{18} . This drops out K_{16} or K_{17} and shuts

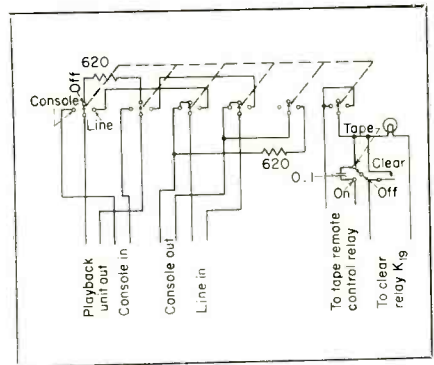

FIG. 5—Circuit of remote-control unit

off the machine. Any number of spots or programs may be played on either machine in this manner.

The audio outputs from the auxiliary tapes, the phonograph preamplifier and the master tape playback amplifier are combined in a fixed mixing network the output of which feeds the automatic gain amplifier. This amplifier provides a nearly constant output with input signals which vary as much as ±15 db from the average. This allows for the considerable level variation in records and recorded tapes of various manufacture.

Program Routine

To facilitate the integration of the Auto-station into the daily programming routine, a remote control box is provided which is used in conjunction with the playback unit. The schematic is shown in Fig. 5. Placed adjacent to the control console, it eliminates the necessity for contact with the playback unit once it has been set up. It contains an audio selector, a tape switch and a clear switch. The audio selector provides three modes of operation: playback unit output to console input with console feeding the line; playback unit output feeding the line with console terminated; or playback unit terminated and console feeding the line.

The first enables the operator to mix the Auto-station program with studio program sources. The second frees the console during long periods of automatic programming, and the last is the regular non-automatic condition. The TAPE switch permits the master tape to be started or stopped from the remote point, and the CLEAR switch de-energizes all control relays, placing the machine in the master mode.

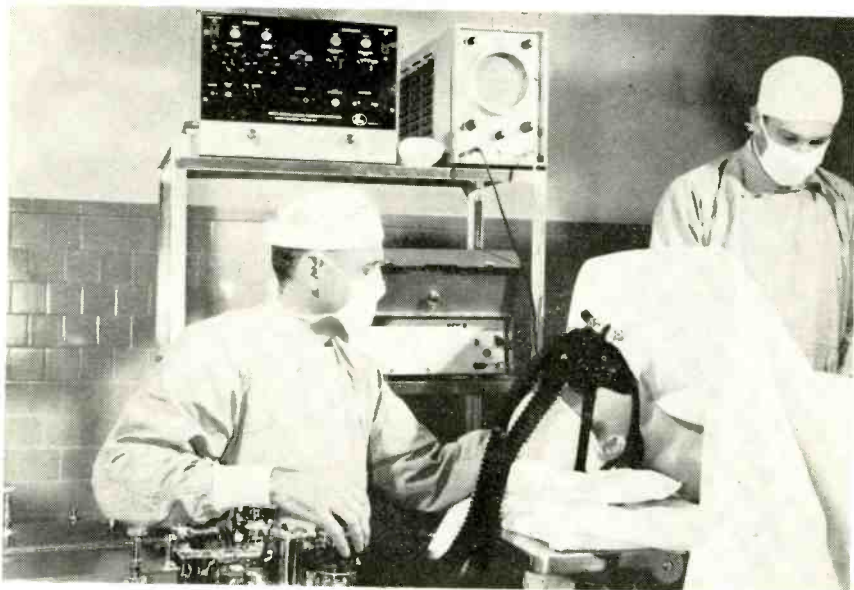

Cardiac instrumentation in use. On top the 5-ft high cart, an area free from the danger of explosion, are a Defibrillator-Pacemaker (single unit at left) and a dual-trace cro. Electrocardiophone mounts on lower shelf due to its explosion-proof construction

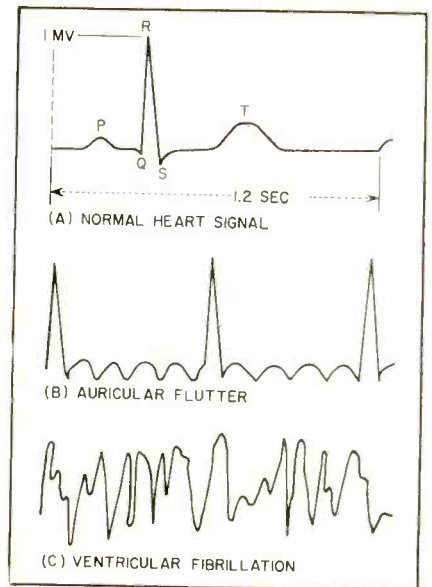

FIG. 1—Potential across shoulders caused by normal (A) and malfunctioning (B, C) heart. Differences must be detected

Tones Monitor Heart's

By **ALBERT J. MORRIS** and **JOSEPH P. SWANSON**

Vice President and Chief Engineer

Asst. Chief Engineer

*Levinthal Electronic Products Inc.
Stanford Industrial Park
Palo Alto, California*

SUMMARY — Frequency of neon-tube oscillator is controlled by amplitude of heart's electrical signal. Resulting tone series gives surgical team a constant check on heart. Explosion-proofed circuitry includes low-distortion differential preamplifier which discriminates against hum

CONTINUOUS monitoring of the heart's electrical activity during surgery has long been recognized as necessary. The problem in such monitoring is not simply that of separating the heart's electrical activity from local interference and amplifying it, but one of presenting the information to the anesthesiologist in such a way that it will give him instantaneous warning when abnormalities occur, yet provide a minimum of distraction at all other times.

The monitor should be portable, explosion-proof, operate reliably in the presence of severe electrical disturbances and produce an undistorted signal for visual observation on an oscilloscope or an electrocardiographic recorder.

The instrument to be described derives its input from two leads typically connected to the patient's right and left shoulders. These leads pick up an electrical signal originating in the heart and connect to a differential preamplifier with 30 μ v sensitivity and frequency range of 0.08 cps to 80 cps.

Heart Rhythm

The amplified signal is used to produce a frequency-modulated audio tone centered at 2,000 cps. The frequency deviation of this tone is roughly proportional to the amplitude and polarity of the input signal. Normal heart rhythm results in three short bursts of sound, each at a different frequency, and each corresponding to

a particular mode of the heart's electrical activity, the *P*, *QRS*, and *T* modes. These sounds may be reproduced by a small loudspeaker built into the instrument or may be monitored by the anesthesiologist alone with headset.

Under normal conditions, the heart rhythm is relatively constant and tends to be accepted as background noise. However, any significant change in this rhythm is forcefully brought to the anesthesiologist's attention.

Electrical Operation of the Heart

Muscular as well as nervous action is accompanied by an electric potential generated across the organ in question. Since a heart beat consists of synchronous action

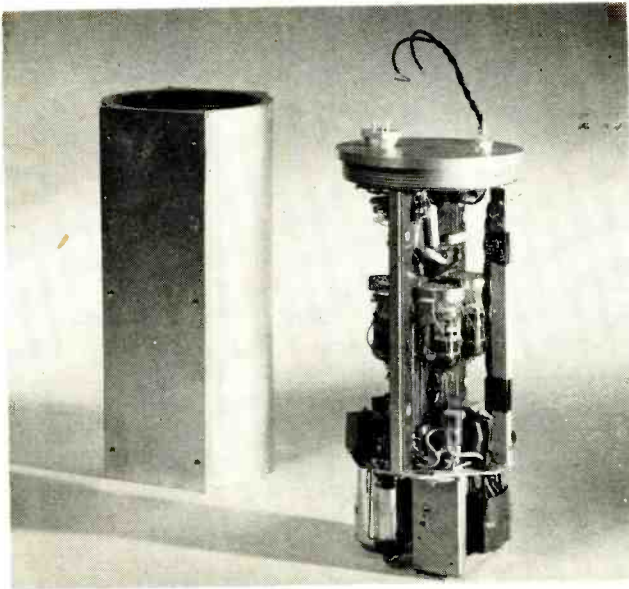

Bulk of circuitry is mounted within aluminum cylinder able to contain any explosion. Power leads are brought through separate header from that used for input/output leads

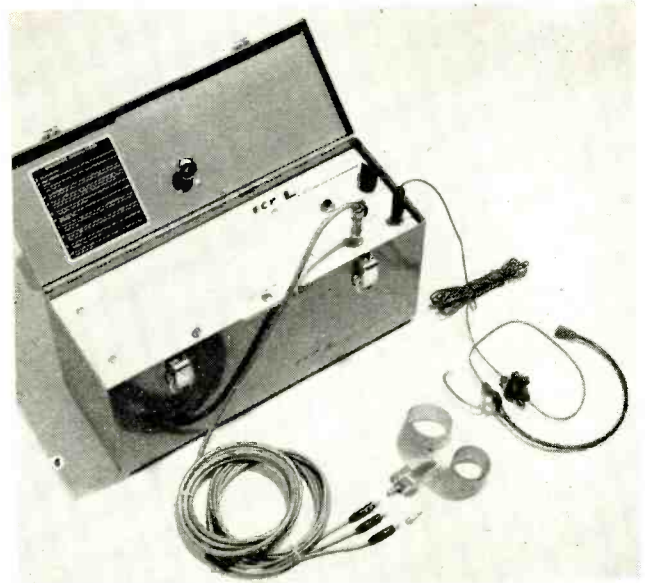

Electrocardiophone carrying case has small loudspeaker mounted in rear. Unit is designed for continuous operation. The entire surface of the carrying case is used as a heat radiator

Electrical Action

of the muscles and nerves of the heart, each heartbeat is accompanied by the generation of a rather large rotating electric vector.

One way to measure this vector is to sample the potential it generates between various points on the body as a function of time. For monitoring purposes, the potential generated across one set of points, usually the patient's right and left shoulders is used. A normal heart signal, as measured between these two points, is shown in Fig. 1A. The signal has three distinct parts, the *P*, *QRS* and *T* modes. These components correspond to the contraction of the auricles, contraction of the ventricles, and refilling of the ventricles, respectively.

Figure 1B shows one type of abnormal heart signal which may be encountered. This particular signal represents auricular flutter. While this condition alone is not too dangerous to the patient, it often serves to warn the anesthesiologist of more serious complications to

follow unless remedial action is taken. To provide this warning, the instrument must be able to distinguish clearly the heart's *P* mode activity.

Two conditions which may occur during surgery call for immediate action by the surgical team. The first of these is cardiac standstill, a complete cessation of ventricular activity and blood flow. The second is ventricular fibrillation which is distinguished by incoherent residual electrical activity and no flow of blood. Ventricular fibrillation gives rise to the electrical signal shown in Fig. 1C. A successful monitoring device must be able to detect these two conditions instantly and distinguish between them.

Preamplifier

The instrument, shown in Fig. 2, takes its input signal from the two patient leads marked RA and LA. A third patient lead marked LL is also included in the circuit. This lead is used to ground the

patient when operating during severe electrical disturbances.

The useful input signal appearing across the RA and LA leads has a peak amplitude of approximately 1 millivolt. This signal is amplified by the two-stage differential amplifier, V_1 and V_2 . The differential-mode gain of this amplifier is approximately 2,000, whereas the common-mode gain is on the order of 0.5. This high ratio of differential-mode to common-mode gain serves to increase the ratio between the signal of interest and the 60-cycle interference voltages always present on the body.

Two separate output signals are supplied by the preamplifier. The first of these is an undistorted replica of the input signal to drive an oscilloscope or electrocardiograph for diagnostic purposes. The second output is used to actuate the tone gate.

Modulation

The instrument must be capable of clearly distinguishing all three

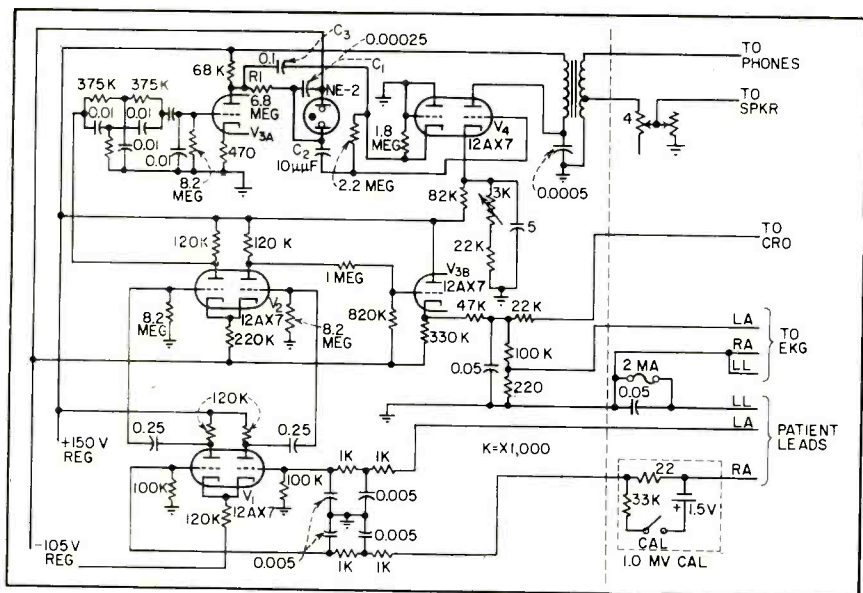

FIG. 2—Circuitry to the left of the dotted line is mounted in explosion-proof case. Low-distortion outputs for csg and ckg are provided

modes of the heart's electrical activity. An early model which amplitude modulated an audio carrier signal was not as successful in distinguishing between these three modes as the present f-m model.

With an a-m carrier, the ear must distinguish between two signals, the *P* and *QRS* modes, separated by a small number of milliseconds in time and by about 20 db in amplitude. The smaller of these two signals, the *P* mode, is almost completely masked by the larger signal which follows it, so that the two modes seem to be a single burst of sound.

With an f-m carrier signal a clearer definition of the three individual modes is obtained. The ear is required to distinguish three sequential signals, differing in frequency but of the same amplitude, a job for which it is much better suited. Tests with the f-m system established that the ear's resolution of the three modes seemed optimum at a center frequency of about 2,000 cycles per second. This resolution is further improved and the disturbing effect of the tone gate greatly reduced if the carrier is gated off at all times when the magnitude of the heart signal falls below some predetermined level.

Tone Gate

The output of the tone gate circuit may be diagrammed as shown in Fig. 3. Only signals larger than

the clipping level cause an audio tone to be passed by the tone gate. The frequency of the audio signal out of the gate is proportional to the amplitude of the actuating signal.

Input signal for the tone gate is derived from one output of the differential preamplifier. It is first passed through a twin-T 60-cps rejection filter and then to the grid of a third stage of amplification, V_{3A} , which raises the peak amplitude of the signal to approximately 40 volts.

This 40-volt signal performs two functions. First, it varies the voltage across a small neon bulb oscillator, consisting of R_1 , C_1 and the bulb. The center frequency of this oscillator is 2,000 cps. A 40-v change at the plate of V_{3A} is sufficient to cause approximately one octave of frequency deviation. A small sample of this frequency-

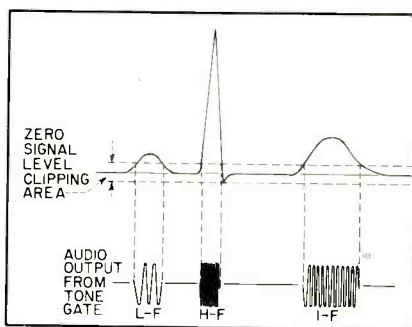

FIG. 3—Simplified tone gate output waveform. Tones are a few milliseconds apart, but may be distinguished by ear

modulated signal is coupled to the grid of V_{4B} through C_2 .

Second, the heart signal from the plate of V_{3A} is coupled to the grid of V_{4B} through C_3 . Tube V_{4B} is biased about four volts below cutoff, however positive heart signals coupled to its grid drive it into the conducting region. When this happens, the f-m audio signal, also coupled to this grid, is amplified and appears at the loudspeaker and earphone output jacks. Thus, the desired audio output of Fig. 3 is obtained. The audio output is kept at constant amplitude because of grid limiting in V_{4B} .

Mechanical Construction

Circuit components are mounted on two phenolic center boards contained within an explosion-proof case. Components are, in most cases, connected by printed wiring. The lower deck mounts the power supply components.

The entire assembly is rigidly attached to a $\frac{3}{4}$ -in. thick aluminum end plate which screws into the explosion-proof aluminum cylinder. Input and output leads are brought through the header, also explosion-proof. Power is fed into the container through a separate header. Special precautions are taken to insure that these leads cannot become damaged in such a way as to cause sparks. The entire assembly is then packaged in an outer case. Input and output jacks and a volume control are brought to the front panel.

Packaging this circuitry in an explosion-proof container raised special thermal problems. Approximately 16 watts are used by the equipment. As much of this heat as possible is conducted to the container walls by metal elements. Since the explosion-proof container itself is well bonded to the outside carrying case, the entire surface area of the carrying case is utilized as a heat radiator. With this approach, the temperature inside the case has been kept close to 60 C with about 27 C ambient air.

We are grateful for the continuing cooperation, efforts and suggestions of Dr. John W. Pender at the Palo Alto Hospital and Dr. Milton S. Waldman and his associates at the Highland Hospital, Oakland.



Infrared photo taken in complete darkness has 600-line resolution at center



Infrared photo reproduced on screen of conventional tv receiver

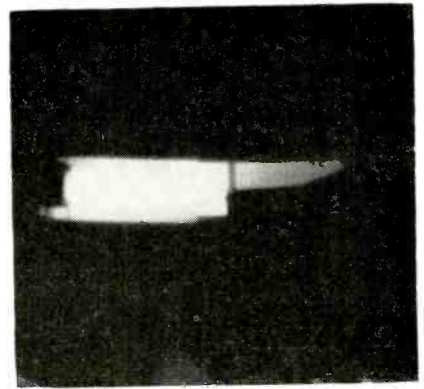

Soldering iron heated to 400 C as seen through infrared viewer

R-F Power Supply for Infrared Viewers

By T. FUJII and H. KOJIMA

*Research Laboratory
Nippon Electric Company Ltd.
Kawasaki, Japan*

SUMMARY — Substitution of r-f power supply for conventional vibrator power supply in sniperscopes or snooperscopes results in noise-free operation and avoids magnetic effects of low-frequency transformer flux leakage

VIBRATOR HIGH-VOLTAGE power supplies used in sniperscopes are heavy, bulky and tend to be unreliable in operation after many hours of service due to poor contact of the vibrator contact. Moreover, the noise produced by the vibrator and the magnetic leakage flux of the power transformer might cause blurred images.

These difficulties are minimized by the use of a r-f power supply.

Conventionally the primary winding of a r-f step-up transformer is used as a part of the oscillator tank circuit and the oscillator must be operated at or near the self-resonant frequency of the secondary winding. The reaction of the secondary circuit upon the primary results in a hysteresis phenomenon appearing in the high-voltage output when the oscillator tank circuit is tuned to resonance from two different directions. This results in instability of operation when the circuit is to be operated at its maxi-

mum output voltage.

These undesirable effects are avoided by operating the oscillator at a frequency slightly off the self-resonant frequency of the secondary circuit. Lower output voltage and higher power consumption are the result.

The circuit in Fig. 1 uses electron coupling to isolate the oscillator from the load, thus realizing both stability and high output voltage with minimum current drain and

without detuning to avoid instability.

Night-vision equipments using the r-f power supply are free from audible noise, compact in size, light in weight and reliable in operation. Blurred image caused by ripple voltage and stray magnetic flux are avoided by providing a set of small-valued capacitors in the filter and bypass circuits.

The authors thank M. Kobayashi, Z. Kamayachi and O. Harashima.

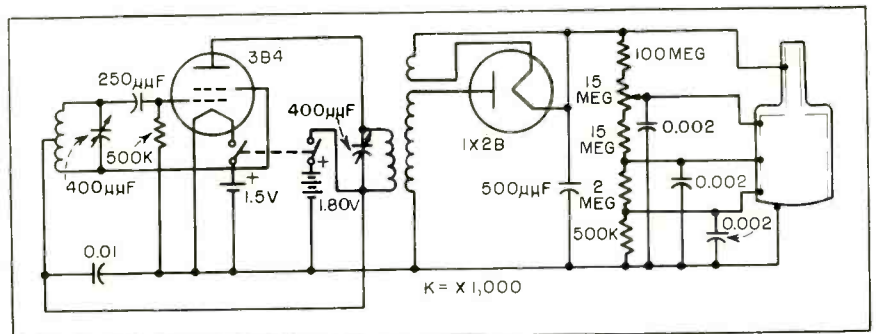
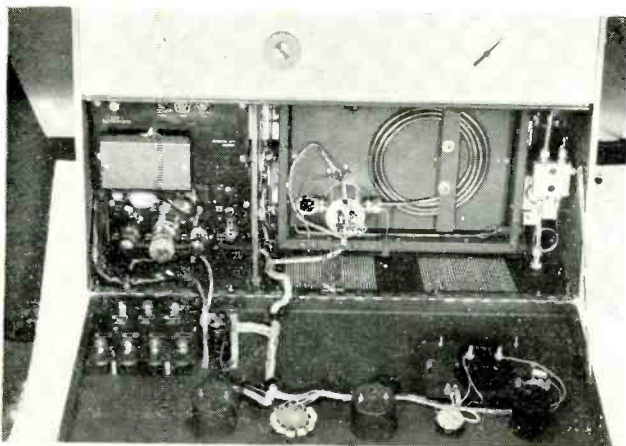

FIG. 1—Electron-coupled r-f oscillator provides noise-free portable high-voltage supply



Interior view of chromatograph shows column mounted directly against bottom plate that is heated by conduction.



Operator uses syringe for injecting sample gas through rubber serum cap. Strip recorder is at left

Electronics Controls Gas

SUMMARY — Heat-controlled instrumentation system, with thermistor as temperature sensing element, automatically maintains any preset temperature between 40 and 225 C within a thermal compartment. Precision voltage regulator supplies 2 to 4 volts at maximum of 400 ma with overall stability superior to a storage battery source.

STANDARD bimetal-thermostatic control of a gas chromatograph causes cyclic variations of the zero line of the recorder due to the high sensitivity of the thermal conductivity cell.

An electronic controlled system has been developed which automatically maintains any preset temperature between 40 and 225 C within a thermal box. It permits the operating temperature to vary over a wide range so optimum resolution can be obtained for a variety of components. This feature facilitates the analyzing of several types of mixtures daily.

Heat-Control System

To eliminate cyclic variations in temperature caused by an on-off system for heat input, the full-proportional heat-control system shown in Fig. 1 was designed.

A thermistor temperature sensing element is one leg of a resist-

ance divider which is returned to a 3-v, low-impedance point. The voltage at the junction of the divider is compared with the cathode voltage of the input tube, which is derived from the same divider and returned to a regulated B+ supply.

Plate current of the input tube is a function of the thermistor divider voltage and the bias stability of the tube. Stability is maintained at 1 or 2 mv per day by the use of an electrometer tube as the input stage.

Its filament is supplied by regulated B+. Since plate voltage of electrometer V_1 thus varies with temperature, the change of plate voltage is amplified and applied as bias to regulator tube V_2 .

The regulator tube drives transformer T_1 whose secondary is in series with the control heater in the thermal compartment; T_1 therefore acts as a variable impedance in series with the control heater. The dynamic range of the system is determined by the impedance ratio of

transformer T_1 . Heater power can be varied from 6 to 90 w as V_3 is varied from cutoff to saturation.

The a-c line produces the 0 to 150 ma plate current required in V_3 , so that no current is required for this stage from the regulated supply. The output transformer center tap is tied directly to the cathode of the output tube and this point is referenced to B+ to maintain proper d-c operating potentials.

Differential amplifier V_2 maintains proper phase for the feedback loop. Any increase in thermal compartment temperature is offset by a decrease in the power supplied to the control heater. The operating temperature can be selected by varying the resistance value placed in series with the thermistor, since the circuit tries to retain the same bias voltage for the input tube. For example, if the series resistor is decreased the circuit will automatically heat the compartment until the thermistor value is also

By WALT DONNER

Assistant Director of Research
Beckman Instruments, Inc.
Scientific Instruments Division
Fullerton, California

Gas Chromatography

... is a simple technique for rapidly and efficiently separating and analyzing materials. A chromatographic column containing an adsorbent material and possibly a high-boiling liquid partitioning agent is used. A vapor sample is injected at the column inlet and is swept by an inert carrier gas through the column.

The adsorbent material separates the sample into its components and the carrier gas removes individual sample components at different rates. Equilibrium among carrier gas, sample components and column material determines the time required for each component to pass through the column.

Gases flow from the column through the sensing side of a thermal conductivity cell exhausted to atmospheric pressure. Carrier gas flows through the reference side. The difference in thermal conductivity between the reference and sample sides produces a voltage differential which is indicated by a strip-chart recorder.

By measuring emergence or elution time from the column, a qualitative analysis is performed. By measuring the area under the resultant trace of the recorder a quantitative analysis is obtained

Chromatography

decreased proportionally to maintain the same voltage at the junction of the thermistor and the series resistor.

Equivalent Circuit

The equivalent circuit of the heater controller is a resistance in series with an impedance applied across voltage E as shown in Fig. 2. The power into the heater is $P_h =$

I^2R where $I = E/(R + Z)$, E is the applied voltage, Z is the impedance offered by the output transformer, I is the current through the heater and R is the heater resistance. Then $P_h = E^2R/(R + Z)^2$ and Z , the impedance required in series with the heater for a given heater resistance and heater power $= -R + E(R/P_h)^{1/2}$. This impedance is transformed to a tube load impedance by the square of the

turns ratio of the output transformer. The actual heat dissipation required in the control tube depends on the ratio of reactance to the resistance offered by the output circuit.

Power Dissipation

Power dissipation required in the output tube is $P_a = EP_h^{1/2}/R^{1/2} - P_h$. Power dissipated in the resistance of the transformer winding must be subtracted from total power dissipation.

A plot of power dissipation versus heater power is shown in Fig. 3 for two values of E . The point of maximum power dissipation shifts along the x axis as the heater resistance varies.

Since the output tube bias is a function of the power applied to the control heater, the bias voltage can be used to control additional power. Normal bias range of the output tube will not trip the relay circuit. When a higher temperature is selected by the temperature step switch, the resultant decrease in bias trips the relay. The relay supplies a booster heater to the thermal compartment which automatically provides power for a large temperature change. As the thermal compartment approaches this new temperature, the bias on the output tube is increased

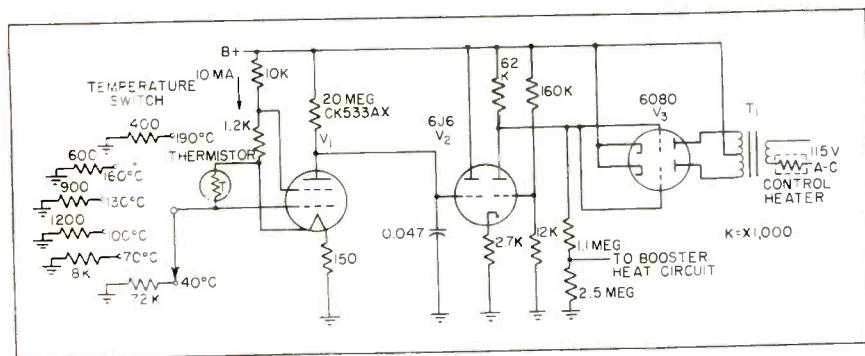

FIG. 1—Thermistor series resistors provide choice of system operating temperatures

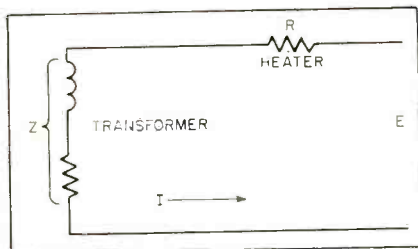

FIG. 2—Equivalent circuit of heater controller simplifies dissipation calculations

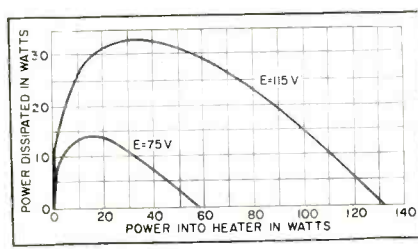

FIG. 3—Variation of dissipation with heater power for a resistor of 100 ohms

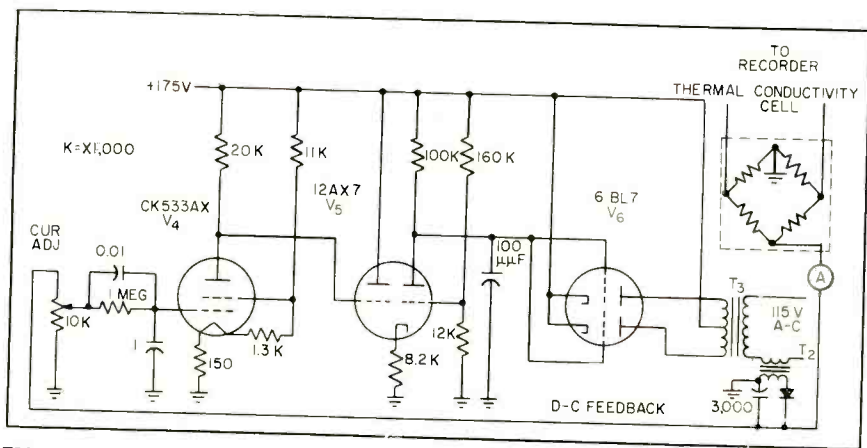

FIG. 4—Detector regulator provides improved zero stability

and the relay drops out. An adjustment provided for minimum temperature overshoot supplies a completely automatic temperature controlling system.

By adding a fixed amount of power in the higher temperature range the regulator will always operate in the center of its dynamic range. This is done by ganging a switch to the temperature-set switch; at the higher temperature positions it provides additional power to the booster heater. This arrangement still allows full proportional control, but a smaller percentage of the total power is controlled by the regulator.

The thermal conductivity cell requires 2 to 4 v over a range of current from 150 to 400 ma. The sensitivity of the cell increases about 10 times as the bridge current is changed over the current range. Therefore, the power supply for the cell must be extremely stable at any current setting. A maximum unbalance of $10 \mu\text{v}$ is permissible during a sample run, which may require up to 1 hour when handling high-temperature boiling liquids.

The thermal conductivity cell is composed of four tungsten filaments arranged in a wheatstone-bridge circuit. Four volts d-c with high stability is required across the bridge when maximum sensitivity of 400 ma is used.

Referring to Fig. 4, the output of T_2 is rectified and applied to the bridge and also to the input of the voltage regulator where it is amplified and applied as bias to control tube V_6 . The amplifier tries to maintain a constant bias on input tube V_4 .

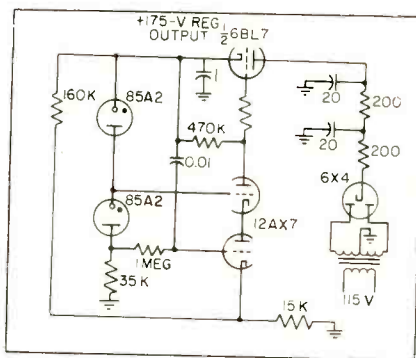

FIG. 5—Regulated +175-v power supply

Sufficient loop gain is supplied so the regulator can cancel normal variations in the a-c line. The regulation required depends upon the balance of the four tungsten filaments in the bridge. If all filaments were exactly balanced no regulation would be required. In practice, the filaments are measured and matched to approximately 2 percent.

Normal bridge unbalance with a battery source is about $20 \mu\text{v}$ per hour. With this electronic regulator zero stability can be main-

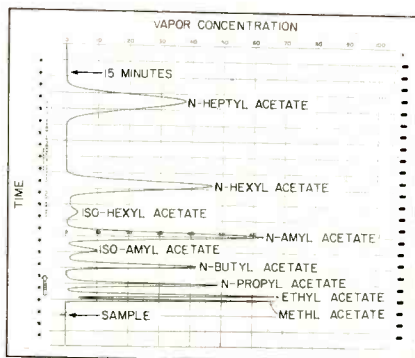

FIG. 6—Chromatograms of acetate esters produced by electronically controlled gas chromatograph. Each peak represents a pure component after complete separation

tained to $20 \mu\text{v}$ per day since it is directly dependent upon input-stage bias stability and not upon a continuously discharging battery. An electrometer tube is again used to maintain as high a bias stability as possible.

The regulator amplifier is direct coupled. The output tube is referred to $B+$ in order to maintain proper d-c operating potentials throughout the amplifier. The input-stage filament divider is composed of wire-wound resistors and supplied from regulated $B+$. The bias stability of this circuit is approximately 2 mv per day, corresponding to about 0.03-percent regulation.

Power Supply

The power supply shown in Fig. 5 consists of a series amplifier using v-r tubes operating with constant current as reference. The series circuit allows high gain to be used with only one amplifier tube. Because of the high-gain regulator amplifier, minimum filtering is required after the rectifier.

The carrier gas flow rate is affected by column temperature and carrier gas pressure at the column inlet. Stabilization is achieved with two pressure regulators and a capillary tube in series with the column. Since the drop across the capillary is approximately 15 psi, a low pressure drop can be reproducibly maintained across the column with the pressure regulators operating in their control range.

Sample Injection

To inject a sample into the column, two methods are provided. A sample valve may be used which injects a fixed volume of sample gas into the helium stream. An alternate method of sample injection utilizes a sample syringe. The syringe can be filled with the liquid or gas sample and the needle point then injected into the instrument through a rubber serum cap.

Column lengths required for analysis of hydrocarbons and other organic components will vary from 18 in. to 40 ft.

A strip recording of acetate esters taken at 160 C column temperature is shown in Fig. 6.

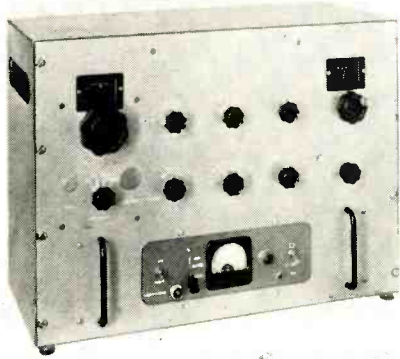

Transmitter with power supply is relay-rack size, yet delivers 100 w on phone

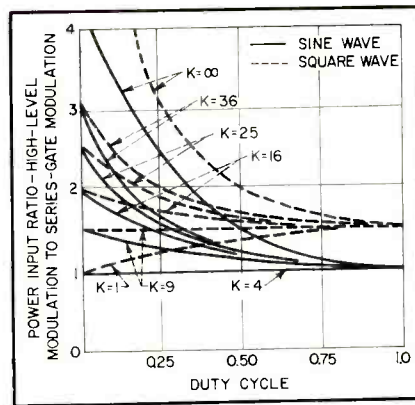

FIG. 1—Relative input powers of high-level and series-gate modulators

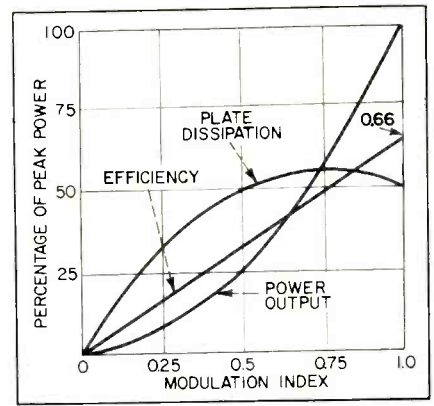

FIG. 2—Peak efficiency of sgm system is equal to that of high-level modulators

Transmitter Cost Trimmed by Series Gate Modulator

By RALPH H. BAER

Vice President
Transistron, Inc.
Manchester, N. H.

SUMMARY — Screen-grid modulator of low audio power approximates efficiency of comparable high-level modulators. Controllable clamping circuit holds residual power output to around one-fifth the no-modulation output of a high-level system. Splatter-free speech clipping is inherent, available simply by increasing modulation level

SAVING SPACE, weight and primary-power requirements is of first importance in airborne, mobile and portable communications equipment. Using the modulation method to be described, radio transmitters of voice or other intelligence for communication may be reduced by at least 50 percent in bulk and weight and 60 percent in primary power requirements, while still giving equal or better results than present a-m systems. The method, known as series-gate modulation, is particularly applicable for equipment whose price range or operational requirements do not justify the additional complexity of suppressed-carrier and sideband techniques.

In high-level modulation systems

commonly employed in a-m transmitters, power for the generation.

Use of the series-gate modulation system reduces physical size of the units and also provides automatic splatterless speech-clipping if desired simply by increasing audio gain, protection against negative overmodulation and reduction of equipment cost by 50 percent.

Operating Principle

To obtain these results the sgm system depends on carrier level control and direct d-c coupled modulation circuitry. It is essentially a form of screen-grid modulation in which relatively low conversion efficiency and normal speech duty cycle are combined to produce high overall efficiency. The residual carrier

level without modulation is held to some fixed fraction of peak modulation level, usually around 1/4 to 1/6. Hence the residual power level is between 1/16 and 1/36 of peak modulation, or 17 to 20 percent of the no-modulation power in similar sidebands must be supplied by the modulator. Under normal conditions, the audio power delivered by the modulator is one-half the d-c plate input power to the modulated stage at 100 percent modulation. This necessitates large tubes and components in the modulator circuit, but the modulated tube operates at an efficiency of about 66 percent. By contrast the efficiency is only about 50 percent with conventional low-level modulation requiring only small audio power.

high-level modulated stage. Since this power level has only mathematical significance in the sgm system, it will be termed the effective no-modulation power output. A residual carrier level is required for ease in tuning the transmission at a receiving station.

As the audio signal increases in amplitude, the modulation of the residual carrier rises to approximately 95 percent. Further increases in audio level raise the average carrier correspondingly, but the negative modulation peaks never go below 3 to 5 percent of peak carrier level. Hence negative overmodulation is averted. Continued rise in audio level will produce similar increases in carrier level up to the point where the positive r-f peak excursions are equal to a new maximum level. This point is determined by the highest positive voltage to which the screen grid of the modulated tube is permitted to rise, and may be considerably in excess of that reached during c-w operation of the same stage. The level now attained corresponds to 100 percent modulation of the full carrier power. Further increases in audio level will result in both negative and positive peak-clipping.

Use of d-c coupling throughout

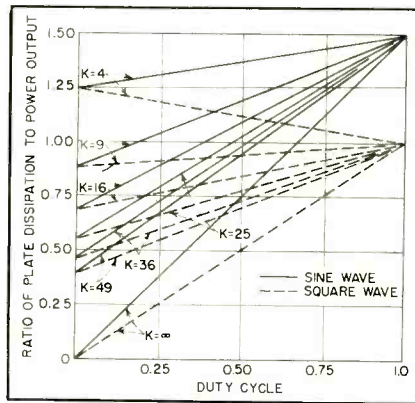

FIG. 3—Square-wave advantage shown is approximated by 10-15 db of clipping

the modulator up to the r-f power amplifier screen grid produces clean, high-level clipping without the transient distortion frequently associated with reactive clipping circuits. Higher-order a-f harmonics generated by the clipping action are suppressed by the screen grid bypass capacitor, while modulation linearity is maintained through the low-impedance cathode-follower drive of the screen grid.

To compare the overall efficiency of high-level modulation with that of sgm it is necessary to take into account the duty cycle of the information to be transmitted. For the high-level modulated stage, as-

suming a class-B modulator operating only during the duty cycle with an overall efficiency of 50 percent, the total d-c plate input power P_{in} with 100-percent sine-wave modulation is $P_{out} (1 + D/0.66)$, where P_{out} is the no-modulation carrier power and D is the duty cycle.

In the series-gate modulation system the efficiency of the modulated stage varies in direct proportion to the output level. Assuming a maximum efficiency of 66 percent on modulation peaks, and letting $k = (E_{peak}/2E_{residual})^2$, then $P_{in} = 3P_{out} [1/\sqrt{y} + (1 - 1/\sqrt{k}) D]$.

A plot of this equation in Fig. 2 indicates that the plate input power requirements of the sgm system are less than those of high-level modulation for identical fully modulated sine-wave carriers, providing k is greater than 4. This relation derives from the increase to 50 percent of the average efficiency of the linear sgm stage at 100 percent modulation, and from the absence of additional modulator power such as that required by the high-level modulated stage.

A further contributing factor is the relatively low overall efficiency—50 percent—with which the audio power for the high-level modulated stage is generated. Hence a decrease

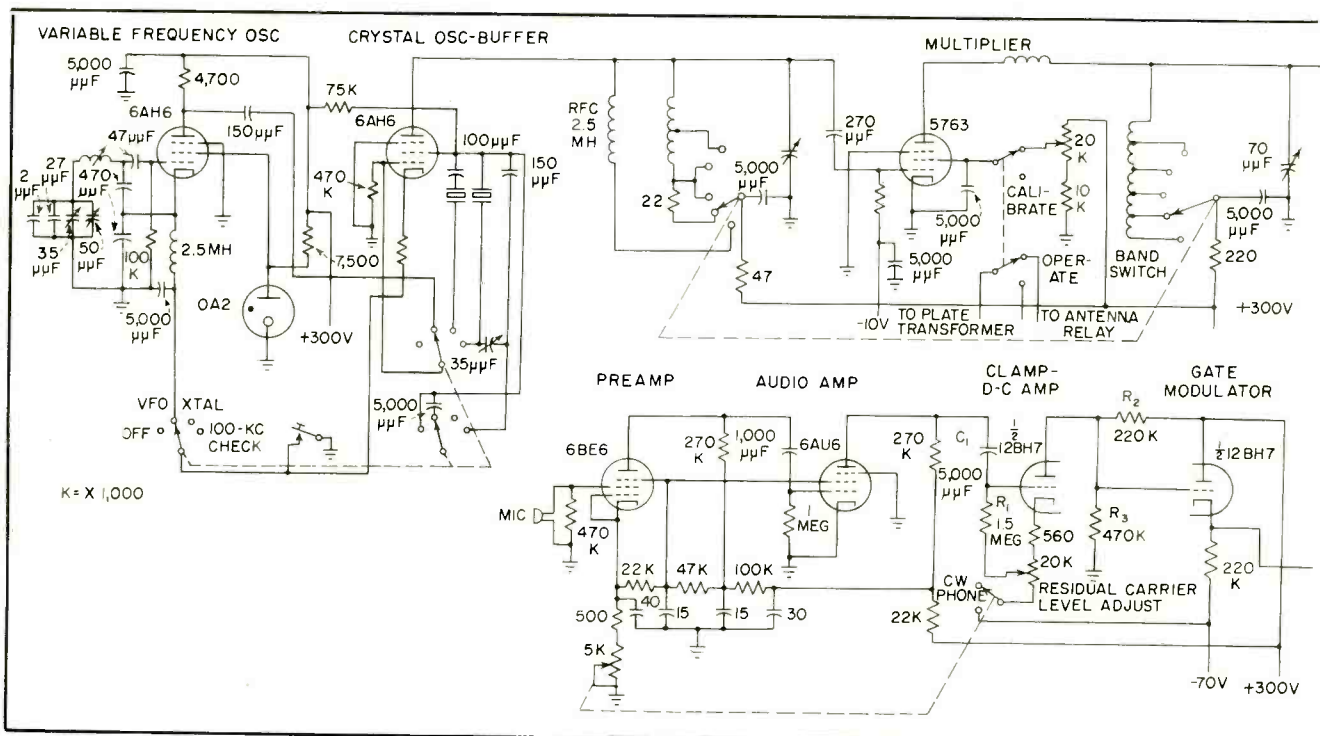

FIG. 4—Schematic of 100-watt prototype transmitter affording c-w operation and a-m phone using sgm system. Bend from 3 to 30

in the size of the sgm plate power supply is permissible.

If symmetrical square-wave modulation is applied to the two systems, for high-level modulation $P_{in} = (P_{out}/0.66) (1 + 2D)$. For series-gate modulation $P_{in} = (m^2 P_{peak}/0.66 m) (1 - D) + (2P_{out}/0.66) D$, where $m = 1/2\sqrt{k}$. Thus no increase in input power is required for sgm since the efficiency has risen to 66 percent.

Plotting these power ratios results in the dashed curves of Fig. 1. These show further possibilities of input power reduction in the sgm system for certain ranges of k and D . Normally a large amount of speech-clipping is feasible, which places the operating conditions in a region between the two sets of curves of Fig. 1.

A choice of average design center values for k and D in the system must also take into consideration the plate dissipation in the modulated stage, which is equal to $mP_{peak} (1.5 - m)$.

The plot of this equation in Fig. 2 shows the plate dissipation curve has a maximum at $m = 0.75$. When $P_{peak} = 4 P_{out}$ the sgm plate dissipation for sine-wave modulation equals $P_{out} [1.5D + 2/\sqrt{k} (1.5 - 1/2\sqrt{k}) (1 - D)]$. This equation is plotted

in Fig. 3. For the high-level modulated stage the plate-dissipation equals $P_{out} (0.33 + 0.17D)$.

The operating conditions which will permit the use of identical tubes in either an sgm or high-level modulated stage will have equal plate dissipations and equal power outputs. Then $D = [0.33 k + (1 - 3\sqrt{k})]/[1.33 k + (1 - 3\sqrt{k})]$, provided $0 < D < +1$ and $70 < k < \infty$, $k = \infty$ (no residual carrier) $D = 0.25$ and identical tubes may be used for the same average and modulated peak power output. When $D = 0.125$, k must be approximately 200. Then residual power output = $1/200 P_{out}$, or practically zero, for equal plate dissipation. For square-wave modulation the sgm plate dissipation is $P_{out} [D + 2/\sqrt{k} (1.5 - 1/2\sqrt{k}) (1 - D)]$. A plot of this equation in the dashed lines of Fig. 3 indicates the reduction in plate dissipation for square-wave modulation as compared with sine-wave modulation. When speech-clipping is employed the actual dissipation will be somewhere between the ranges of these two sets of curves.

Speech Clipping

Peak-clipping of the speech waveform can aid materially in raising the average modulation level. Approximately 10 to 15 db of clipping is normally desirable, and this will increase the effectiveness of the transmission several hundred percent, while maintaining voice quality adequate for communications. The success of any speech-clipping system depends in part on its ability to suppress higher-order harmonics generated in the clipping process. If these were permitted to modulate the carrier considerable sideband radiation (splatter) would result.

Conventional speech clippers incorporate low-pass filters to reduce these audio harmonics to acceptable levels. But unless clipping is done at the point of modulation injection into the r-f stage, phase shifts in the audio amplifier stages following the clipper circuit will have the effect of tilting the flat-top waveforms developed by the clipper-filter combination.

In the sgm system these difficulties are avoided by obtaining clipping action in the grid and plate

circuit of the voltage amplifier driving the cathode-follower modulator, to which it is d-c coupled. Attenuation of about 6 db per octave below approximately 400 cps is provided by the coupling networks of the microphone preamplifier. This aids in the reduction of the vowel bass content of normal speech which is largely responsible for the peak excursions of composite waveforms.

Practical Circuit

As shown in Fig. 4, the modulator is a 12BH7 twin triode. The first half is used as a voltage amplifier, the second half as the output cathode follower. A conventional r-c coupled amplifier precedes the modulator tube. Small coupling capacitors reduce the frequency response of the amplifier at a rate of 12 db per octave below 1,000 cps.

Capacitor C_1 and resistor R_1 provide a method of grid clamping. This results in a shift of average d-c potential at the junction of R_2 and R_3 which is proportional to the peak-to-peak amplitude of the incoming audio signal.

The junction of these two resistors is coupled directly to the grid of the cathode follower. This results in a shift of screen-grid potential of the r-f amplifier tubes. As a result both carrier level shift and audio modulation are simultaneously applied to the screens of the final tubes. The low output impedance of the cathode follower helps maintain good waveform, despite the varying load presented by the screen grids of the final.

In addition to this action speech-clipping is automatically obtained by increasing the input to the modulator so that the amplifier tube grid cuts off on negative peak swings. The maximum voltage to which the final screens can rise is determined by R_2 and R_3 , and it is therefore completely controllable through a change of value of these two resistors. High-order harmonic products generated as a result of speech clipping are effectively reduced by the screen-grid bypass capacitors. Using this system, it is entirely feasible to operate a 250-watt transmitter from a six-volt car battery or a 10-watt unit from portable-radio type dry batteries.

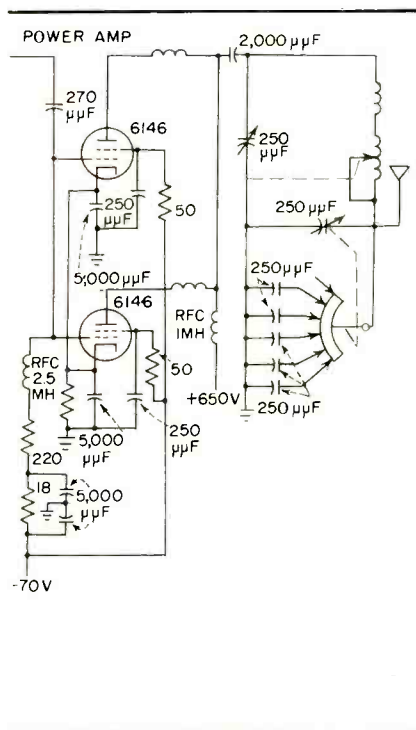

mc is covered by vfo or selectable crystal

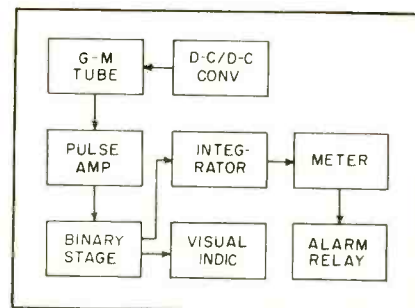

FIG. 1—Block representation of gamma-ray detector

Geiger-Muller tube is housed in external unit partially seen at lower right

SUMMARY — Transistorized instrument detects gamma radiation over 1 to 1,000 milliroentgen per hour range with accuracy of ± 40 percent. Alarm, which is adjustable from 10 to 900 mr per hr, indicates when radiation exceeds preset value. Reliability is achieved partially by simplicity of circuit design; all active circuits, except for power supply, are multivibrators

Gamma-Ray Monitor

By J. M. JACKSON and J. J. SURAN

*H. M. E. Department
Electronics Laboratory
General Electric Company
Syracuse, New York*

PROBABILITY that a complex circuit will fail is usually a function of the number of components in the circuit. Hence, reasonable objectives for a reliable design are to use a minimum number of components and to make those that are used as individually reliable as possible.

On the basis of these considerations and in the light of component availability, it was decided to transistorize an entire gamma detector with the exception of the detecting element, a Geiger-Muller tube of a conventional and proven type.

System Description

A block diagram of the gamma-radiation monitor is given in Fig. 1 and the circuit diagram is shown in Fig. 2.

The detecting element followed by a pulse amplifier increases the

energy level of the signal pulses and also performs a discrimination function to minimize noise effects. The amplified pulses are fed to a binary counter which converts the pulse train to a square wave of constant amplitude and of frequency equal to one-half the pulse repetition rate of the signal. One of the outputs from the binary stage is to a visual-count indicator circuit.

A second output from the binary stage is to an integrating circuit which converts the square wave to a d-c signal whose amplitude is proportional to the frequency of the square wave. A current-sensitive relay in series with the output meter actuates an alarm device when the radiation level exceeds some predetermined safe value.

The detecting tube is sensitive to gamma radiation but has almost

no response to alpha, beta or neutron radiations. Its output consists of a train of pulses at a repetition rate proportional to the intensity of the gamma radiation field. An experimental curve of the response of the tube type used in this circuit is illustrated in Fig. 3. The output pulses tend to be uniformly large at low count rates, but as the rate increases a larger percentage of the pulses become smaller in amplitude.

Transistor Selection

Detailed consideration of the circuit specifications for the entire system led to the conclusion that, with a single exception in the power supply, one transistor type could be used throughout.

Transistors with an α_b cutoff frequency of 1 mc are more than adequate in this application.

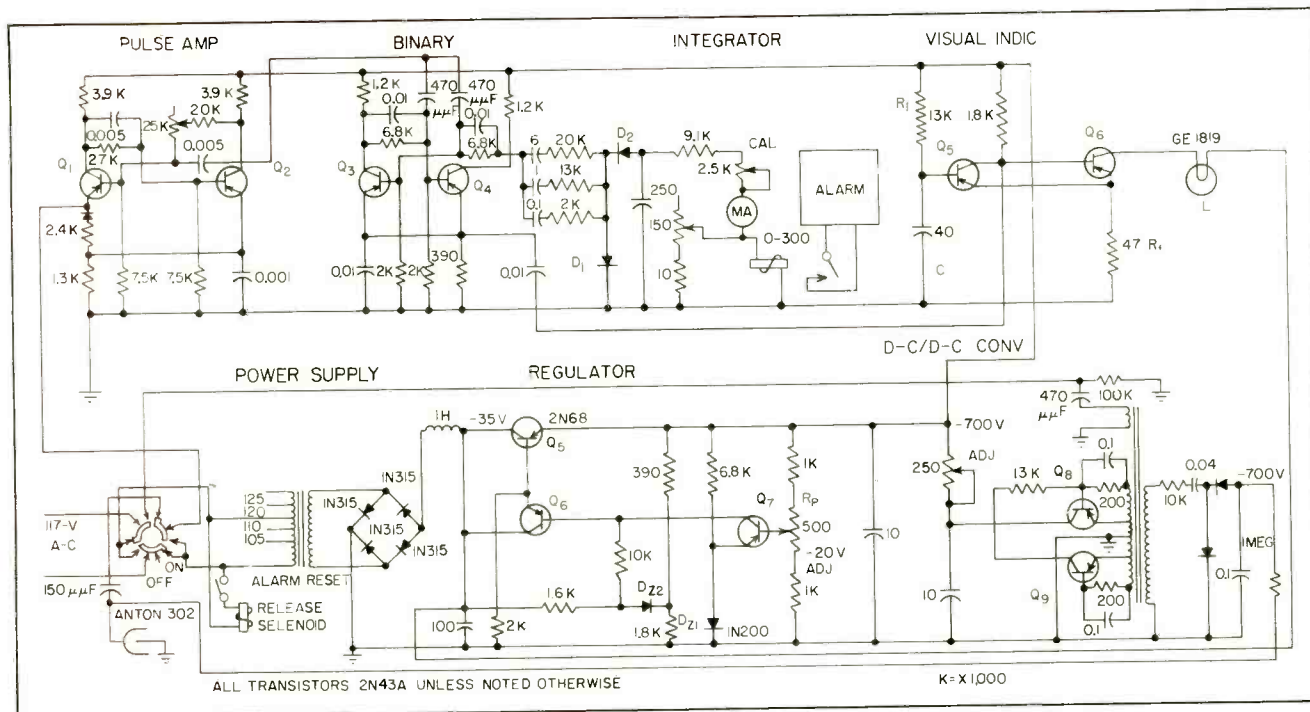

FIG. 2—Eleven-transistor unit uses type 2N43A in all circuits except for two 2N68's in regulator

Has High Reliability

Though current-amplification factors of 30 or greater are desirable, the designs were based on a lower figure to insure reliable operation despite aging effects. Reverse leakage current of less than $2 \mu\text{a}$ at room temperature were specified to insure adequate performance over the desired ambient temperature range.

An inverse collector-to-emitter voltage rating of at least 20 v was selected to facilitate the design of the power supply. Finally, a power dissipation rating of 100 to 150 mw at room temperature was specified to insure a proper margin for derating.

On the basis of these desired properties, the type 2N43A *pn*p

alloy transistor was selected for all the circuits except the voltage regulator for which a 2N68 *pn*p alloy power transistor was selected.

Pulse Handling

Pulses from the G-M tube feed a monostable multivibrator configuration of the type illustrated in Fig. 4.¹ Inclusion of R_e in the emitter lead of Q_1 unbalances the normally bistable circuit and makes it monostable. In the monostable mode, Q_1 is normally cut off and Q_2 is conducting; Q_2 is unsaturated in its conducting state for maximum circuit sensitivity.

Diode D provides a high-impedance triggering point for the G-M tube, thus eliminating the necessity for an additional buffer stage between the detector and amplifier. Since the cutoff potential developed across R_e divides between the back resistances of D and the emitter-base junction of Q_1 , it is desirable to have the back resistance of

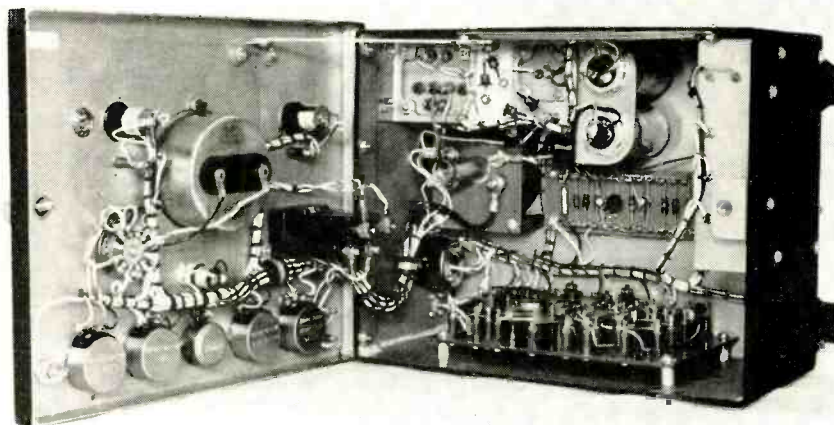

Inside view of transistorized gamma-ray monitor shows component location

D of the same order of magnitude as the back resistance of the transistor emitter-base junction.

A positive pulse from the G-M tube triggers the multivibrator into an unstable state where Q_1 conducts and Q_2 is cut off. While in its unstable state, pulses from the G-M tube will have no effect on the circuit. The recovery time of the multivibrator may thus be used to discriminate against after-pulses from the detector by making the time constant of the circuit longer than the expected duration of the after-pulses. For the circuit of Fig. 4, the recovery time of the multivibrator is 50 μ sec.

Triggering Requirement

The amount of charge required to trigger the monostable multivibrator is a function of the α -cutoff frequency of the transistors and the conducting level of Q_2 .² An approximate equation for the charge requirement is

$$Q_T \cong \frac{I_{c2}}{\omega\alpha_b} \cong \frac{1}{\omega\alpha_b} \left(\frac{R_b}{R_b + R_k + R_1} \right) \left(\frac{E_{bb}}{R_f} \right) \quad (1)$$

where Q_T is the trigger requirement in coulombs, I_{c2} is the collector current of the conducting transistor in amperes prior to triggering and $\omega\alpha_b$ is the cutoff frequency of the transistors in radians per second. For the circuit of Fig. 4, Q_T is approximately 5×10^{-10} coulombs.

Discrimination against low-charge noise pulses is accomplished by adjusting the steady-state conduction current of Q_2 by varying R_f .

The charge available from the G-M tube during a primary discharge is approximately 10^{-9} coulombs, providing a trigger margin of at least 100 percent. The output of the multivibrator consists of a negative pulse 50- μ sec wide and approximately 10 v in peak amplitude.

The binary stage can load the circuit appreciably without adversely affecting the operation of the monostable multivibrator during the regenerative cycle. An estimate of the peak pulse power gain of the amplifier circuit is 25 to 30 db.

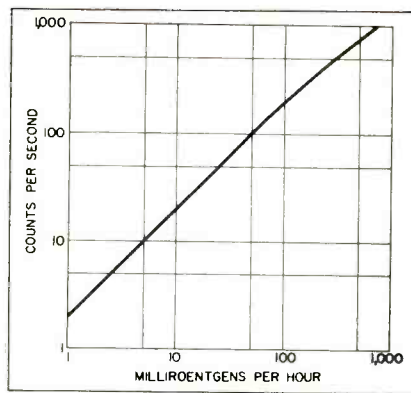

FIG. 3—Characteristic of Anton 302 Geiger-Muller tube

The binary stage is a conventional emitter-coupled flip-flop which is base-triggered by the negative pulses from the pulse amplifier stage. The coupling capacitors are selected so that its recovery time is less than one-half the period of the highest frequency anticipated.

Negative pulses from the pulse amplifier are applied simultaneously to the bases of both transistors in the flip-flop circuit. Since comparatively low pulse frequencies below 10 kc are anticipated, a diode routing gate in the trigger circuit is not required. For optimum trigger action the flip-flop is designed as a nonsaturating circuit.¹

Logarithmic Integration

The collector swing of the binary transistors is 10 v and 10 ma. The collector of Q_1 is loaded by a logarithmic integrating circuit which delivers a d-c current to the output meter. Since the output meter must cover a range of three decades, 1 to 1,000 mr/hr corresponding to approximately 1 to 1,000 counts per second, the amplitude of the d-c output from the integrator is required to be proportional to the logarithm of frequency.

Logarithmic conversion is obtained by a simple R-C network attached to the collector of Q_1 . When the collector of Q_1 swings negative, a quantity of charge is pumped into the 250- μ f capacitor and the charge magnitude is determined by the R-C network time constants.

During the positive half of the square wave D_1 conducts and D_2 is

blocked, isolating the capacitor from the binary and maintaining a flow of d-c into the output meter. As the frequency of the binary multivibrator increases, due to increased gamma activity, more charge is pumped thus increasing current to the output meter. By proper selection of the R-C time constants and by scaling the series resistance values of the R-C branches so that the current flow always tends to increase logarithmically with increasing frequency, a good approximation to a logarithmic response is obtained.

Statistical Smoothing

The capacitance value is large to provide a long time constant in the output circuit. For the circuit in Fig. 2, the integrating time constant is approximately 2.5 sec. Such a long integration period is required to smooth the statistical variations in the count rate.

The output meter is calibrated directly in milliroentgens per hour and hence provides a continuous indication of the average gamma radiation intensity. The current-sensitive relay in series with the meter provides a high-level alarm.

The setting of the alarm point, which may be varied from 10 to 900 mr/hr by a variable resistor shunting the relay coil, is complicated by the random nature of detected radiation. If the alarm is set too close to an ambient level, inadvertent alarm triggering may occur due to statistical variations in the count range. Setting the alarm point experimentally by use of a calibrated cobalt-60 source has proved to be the most satisfactory means for determining the proper alarm level.

Visual Count Indicator

The visual-count indicator causes a lamp to flash every time a gamma interaction occurs in the G-M tube. A circuit of this type is useful only in the low-count region since the resolution of the eye is limited to approximately 20 flashes per second. Nevertheless, it is of inestimable value as a psychological channel to indicate that the circuit is operating satisfactorily.

A direct-coupled monostable trigger circuit meets the requirements of the monitor. Transistor Q_5 is normally conducting and Q_6 is held cut off by the low collector potential of Q_5 and by the voltage drop across R_7 . Capacitor C is therefore charged to a low potential which is approximately equal to the voltage drop across R_7 . Since indicating lamp L is in the collector circuit of Q_6 , the lamp is normally off.

Lamp Lighting

If a negative pulse is applied to the base of Q_6 , the latter is momentarily pulsed into a conducting state. The flow of current in the emitter of Q_6 will increase the negative potential across R_7 , but since the base of Q_5 is momentarily maintained at a constant potential by C , Q_5 is forced into a cutoff state. This action causes the negative potential at the collector of Q_5 to increase which in turn drives Q_6 into saturation, thus lighting L .

At the termination of the trigger action the capacitor begins to charge through resistor R_7 . When the negative potential across C becomes equal to the potential drop across R_7 , Q_6 begins to conduct causing its collector potential to drop, hence, Q_5 is driven back to a cutoff state. The lamp is then extinguished and remains so until another trigger pulse from the binary stage initiates the circuit action. The resolution of the indicator circuit is

$$f_r \cong \left[R_7 C \ln \left(\frac{E_{bb} - E_1}{E_{bb} - E_2} \right) \right]^{-1} \quad (2)$$

where E_{bb} is the supply voltage of Q_5 , E_1 is the potential drop across R_7 under quiescent conditions and E_2 is the potential drop across R_7 when the lamp is lighted. For the circuit in Fig. 2, Eq. 2 indicates a maximum resolution of approximately 20 pps. Any higher frequency will result in a constant glow of the indicator lamp.

Reliable Triggering

Separate voltage supplies for Q_5 and Q_6 are used in the indicator circuit since a regulated voltage supply is required only for Q_5 to insure reliable trigger action. Consequently, the watt of power re-

quired to flash the lamp may be drawn from the unregulated supply and thus does not impose unnecessary power drain upon the regulator circuit.

The trigger source for the indicator is the common emitter resistance of the binary-stage flip-flop. A negative pulse occurs at this point each time the binary multivibrator is triggered from the pulse amplifier. In addition, the common-emitter terminal of the binary circuit is a low-impedance point and hence is not seriously loaded down by the visual-count circuit.

Power Supply

The power supply requires an accurate voltage regulator and high-voltage generator. Good voltage regulation is required for the G-M tube since a variation of ± 2 percent about 700 v may result in improper tube response. Close regulation is also required for the multivibrator circuits to insure constant output levels.

The regulator circuit maintains

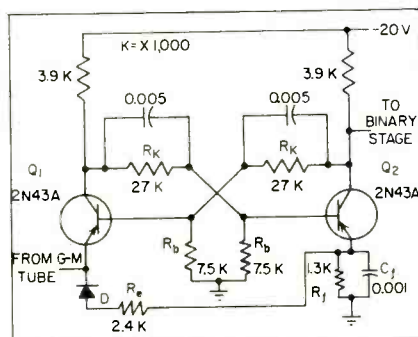

FIG. 4—Monostable multivibrator serves as pulse amplifier

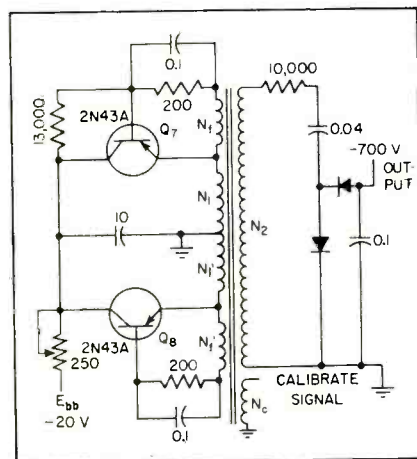

FIG. 5—Voltage-doubler d-c/dc converter supplies 700-v excitation for G-M tube

the voltage level against variations of load impedance as well as against input voltage fluctuations. The reference voltage, from which the difference feedback voltage to a series-regulating element is established, is obtained from zener diode D_{z1} . The difference voltage is amplified by Q_8 and Q_9 and fed back to the base of power transistor Q_7 which is in series with the line and which constitutes the regulating element. A second zener diode reference, D_{z2} , stabilizes the base and collector supply voltages of feedback transistors Q_8 and Q_9 respectively, thus making the amplifier gain virtually independent of input voltage changes. Adjustment of the regulated output voltage may be made manually by variation of R_p .

The regulator circuit has an output resistance of approximately 0.2 ohm and regulates the 20-v supply within 1 percent over a temperature range from 0 to 50 C.

High-Voltage Generation

High voltage for the G-M tube is obtained from the d-c/d-c converter of the type illustrated in Figs. 4, 5. A square wave of alternating voltage is generated when the transistors alternately switch supply voltage E_{bb} across transformer windings N_1 and N_1' . Regenerative feedback is supplied by windings N_2 and N_2' .

Frequency of operation is governed by the magnitude of the supply voltage and the saturation properties of the square-loop transformer material. If ϕ_s is the saturation flux in webers and if $N_1 = N_1'$, the frequency of oscillation is

$$f = E_{bb} / (4 \phi_s N_1) \quad (3)$$

Since E_{bb} is a regulated voltage and ϕ_s is fairly temperature insensitive over a wide range of temperature, the frequency of the converter is constant. This property may be used in calibration of the monitor equipment by employing the converter as an internal generator for testing the indicator circuits by taking the calibration signal off winding N_c .

The voltage across secondary N_2 is rectified and filtered in a voltage doubler configuration. The re-

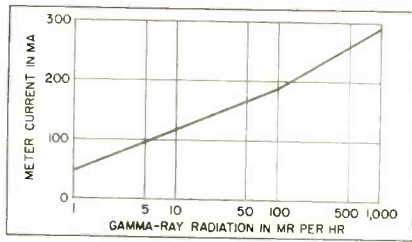

FIG. 6—Output characteristic of complete instrument

sistor in series with the secondary winding limits the maximum current flow in the secondary circuit. A fine adjustment of the d-c output voltage may be made by variation of the 250-ohm potentiometer, which adjusts the collector potential of the transistors within a small margin.

The converter operates at a frequency of 500 cps. The transformer turns ratio (N_2/N_1) is 17.5 and the core is a toroid fabricated from Orthonol square-loop material. Supply voltage E_{bb} is from the 20-volt regulated line.

System Performance

The output response characteristic of the circuit, showing d-c output current as a function of radiation intensity, is illustrated in Fig. 6.

The circuit is calibrated by switching the input of the pulse amplifier from the G-M tube to the differentiated output of the calibration-signal winding on the high-voltage transformer. The meter current under these conditions is known, since the frequency of the converter is constant; therefore, the meter-circuit resistance may be adjusted until a correct reference reading is obtained. Calibration by this means eliminates the effect of component variations which could cause minor differences in the output readings from unit to unit.

Count-rate calibration is not rigorously analogous to radiation calibration. However, the technique does meet the accuracy requirements of the system and provides a simple method for individual adjustments. For calibration in the lower two decades, the circuit depends upon the assumption that the G-M tubes exhibit approximately the same characteristics. Experience shows that this

is a reasonably valid assumption and leads to only negligible errors.

Operational Accuracy

Once the system is calibrated, continued accuracy of the output indication depends upon the voltage stability of the regulating circuits. For example, if the output meter is rated as accurate to within 1 percent and has a full-scale deflection of $300 \mu\text{a}$, the error anywhere on the scale may be as high as $3 \mu\text{a}$.

Since the meter is marked in three logarithmic decades, an error of this magnitude corresponds to one thirty-third of a decade or approximately 7 percent in the indication. Consequently, a 2-percent change in the supply voltage, which leads to the same percentage change in the voltage output of the binary stage, could result in a maximum error of almost 15 percent in the meter indication.

This sensitivity can be reduced by the addition of an emitter-follower amplifier stage between the binary multivibrator and the logarithmic integrator circuit, providing a larger current for the output meter and permitting the use of a meter with a larger full-scale current rating. However, if the voltage regulator circuit is adequate for the required accuracy, as in the present design, the additional transistor stage is not necessary.

Drift

Operation of the monitor over an ambient temperature range of 0 to 50 C meets the given accuracy requirements since the drift in output indication for a single unit is no greater than ± 40 percent.

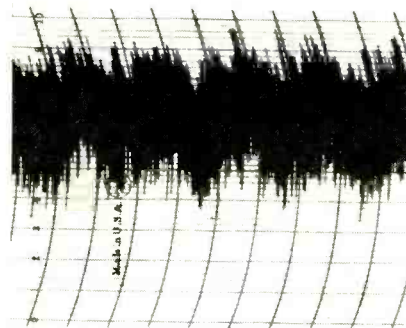

FIG. 7—Five-hour recording of output response to radium watch-dial source. Vertical divisions are $5 \mu\text{a}$

The multivibrators in the indicating circuits are stabilized against temperature changes by the d-c bias network so that under the worst possible conditions the amplitude of the output pulse from the amplifier circuit does not vary more than ± 10 percent and the output amplitude from the binary stage does not vary more than ± 2 percent over the 50 C temperature range.

Frequency stability of the converter in the same temperature range is better than ± 2 percent. It is estimated that most of the observed drift is due to component variations in the logarithmic integrating circuit.

Radium Response

A 10-hour pen recording of the gamma monitor output current response to a radium watch-dial source is illustrated in Fig. 7. Each major division along the horizontal axis is a one-half-hour time unit and each major division along the vertical axis is a $5\text{-}\mu\text{a}$ unit. The cyclic variations of 1-hour periods are due to the motion of the minute hand. Added to the hourly variations is a 12-hour cycle due to the motion of the hour hand. Statistical variations from the average radiation level are as much as ± 50 percent.

The authors are indebted to W. A. Andrews of the Heavy Military Electronic Equipment Department for his valuable assistance. In addition, the helpful suggestions of H. W. Abbott, E. P. Cleary and D. A. Paynter of the Electronics Laboratory are gratefully acknowledged.

This work was supported by the Bureau of Ships, U. S. Navy, under contract number NObsr-72530.

REFERENCES

- (1) J. J. Suran and E. A. Reibert, Two-Terminal Analysis and Synthesis of Junction Transistor Multivibrators, *IRE Trans of PGCT*, Mar. 1956.
- (2) J. G. Linvill, Non-Saturating Pulse Circuits Using Two Junction Transistors, *Proc IRE*, July 1955.
- (3) H. R. Lowry, Transistorized Regulated Power Supplies, *Elec Des*, Feb. and Mar. 1956.
- (4) D. A. Paynter, An Unsymmetrical Square Wave Power Oscillator, *IRE Trans of PGCT*, Mar. 1956.
- (5) G. H. Royer, A Switching Transistor DC-to-AC Converter Having an Output Frequency Proportional to DC Input Voltage, *AIEE Winter General Meeting*, Paper No. 55-73, Jan. 1955.

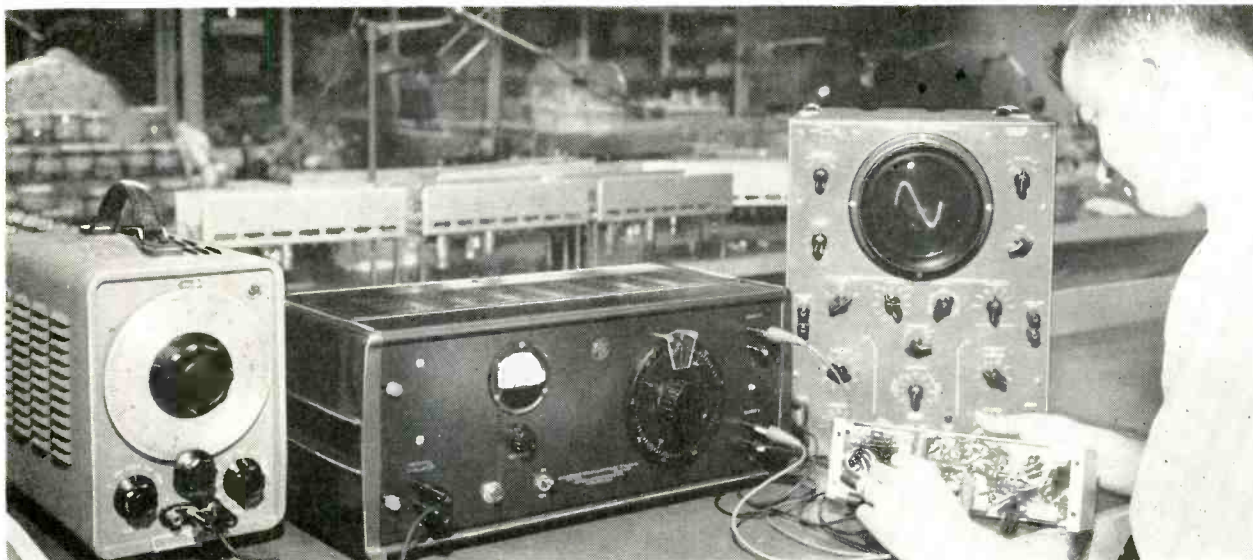

Phase-sensitive equipment is checked in laboratory with resistive-type phase generator

Phase Generator Has Resistive Shifter

By **GEORGE E. PIHL**

*Director of Instrument Engineering
Acton Laboratories Inc.
Acton, Massachusetts*

SUMMARY — Pair of sinusoidal signals are supplied over range from 20 cps to 20 kc with accurately known phase relation that is continuously adjustable over 360 deg. Phase-shifting network with linear wire-wound potentiometer is excited by quadrature voltage derived from modified phase-difference network. Phase calibration is linear with respect to dial rotation

SIGNAL SOURCES capable of supplying pairs of voltages with controlled and accurately known phase relations are useful in the investigation of phase-sensitive equipment.

Phase Shifting

The phase generator to be described supplies a pair of sinusoidal output signals having an accurately known phase relation that is continuously adjustable over a 360-deg range. The critical phase shifter network of the generator, shown in Fig. 1 and 2, uses a resistive phase shifter which is oper-

able over the frequency range from 20 cps to 20 kc. It is excited by quadrature voltages derived from a modified phase difference network.

A signal of the desired frequency is applied simultaneously to a pair of phase-shift networks, each consisting of a cascaded arrangement of phase inverters and all-pass half-lattice sections. Within the design frequency range of the networks, output voltages E_1 and E_2 will be separated by approximately 90 deg. Voltages E_1 and E_2 are nearly equal in magnitude since only all-pass networks and degenerative phase inverters are involved

in the networks. Therefore it is possible to obtain another pair of voltages almost 90 deg out of phase by taking the sum and difference of E_1 and E_2 , as shown in the vector diagram of Fig. 1. The sum and difference voltages E_3 and E_4 are different in amplitude by an amount dependent upon the departure of the original phase angle from 90 deg.

Quadrature Voltages

Voltages E_3 and E_4 may be passed through opposed attenuators to restore the amplitude equality and applied to phase inverter stages to

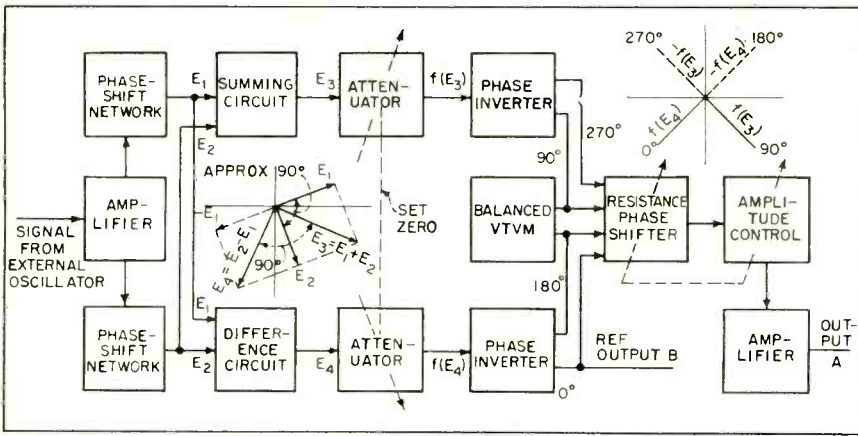

FIG. 1—Phase generator has resistive phase shifter excited by quadrature voltages. One output bears known phase relationship with one input

Table I—Resistive Phase Shifter Relationships

Mechanical Angle θ (deg)	Electrical Angle ϕ (deg)
0	0
5	4.96
10	9.96
15	14.97
20	19.99
25	25.01
30	30.01
35	35.02
40	40.01
45	45.00

produce a quadrature voltage system. A null detector or balanced vtm provides for this adjustment. These quadrature voltages excite the phase shifter from which one output is derived bearing a known angle with respect to one of its input voltages.

A broad-band, resistive phase-

shifter was developed for this system. It consists of a linear, 360 deg wire-wound potentiometer having taps brought out at precisely 90 deg intervals as shown in Fig. 3.

Disadvantages

When the potentiometer is fed with quadrature voltages, the out-

put voltage can be varied in phase throughout the 360-deg range.

The nonlinear relation between electrical and mechanical phase angles and the change in amplitude of the output voltage as the control is rotated are disadvantages.

The first of these difficulties can be resolved by the method in-

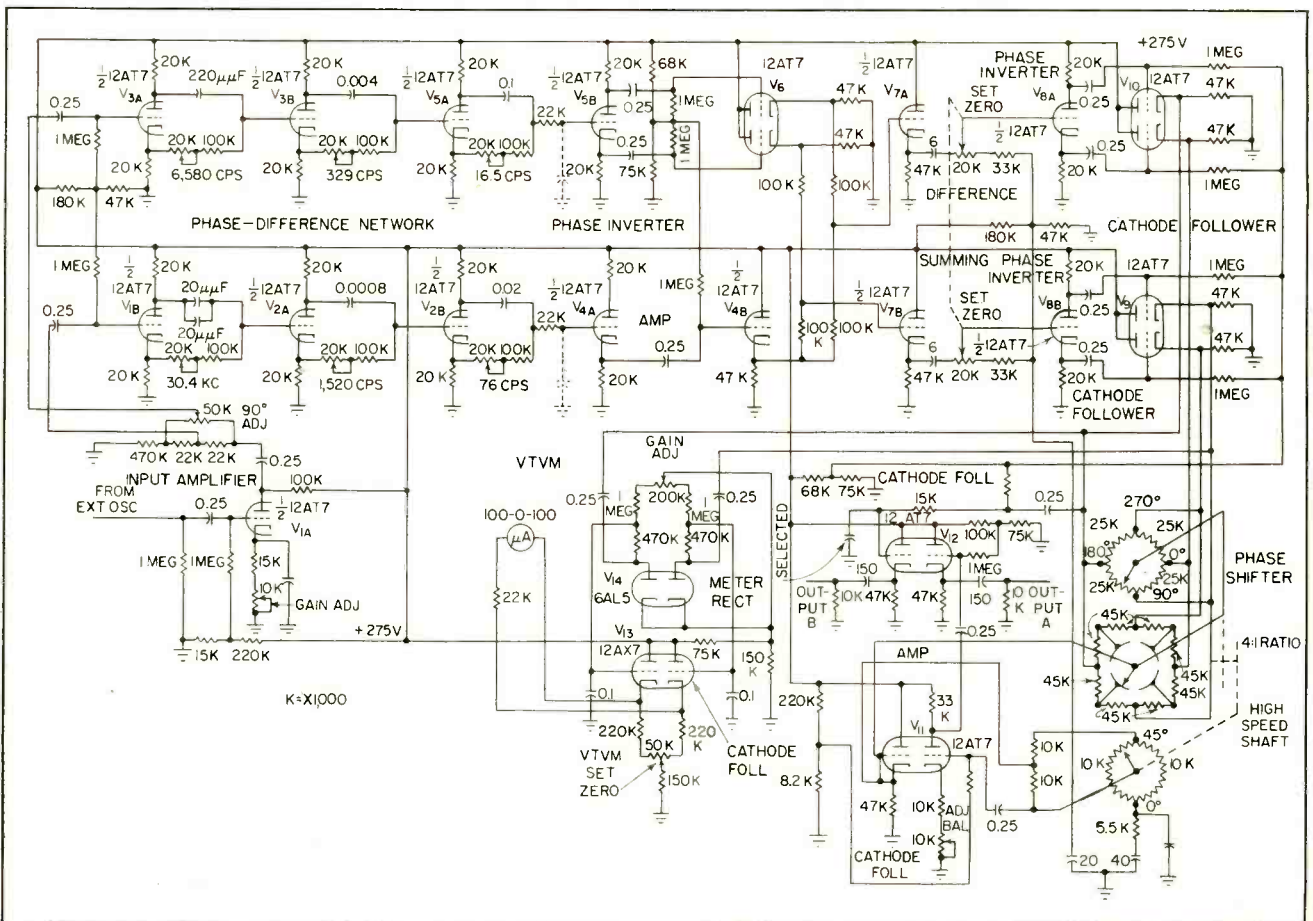

FIG. 2—Phase generator uses differential vtm. Phase inverters for driving half-lattice phase-shift networks comprise the phase difference network

Table II—Amplitude Potentiometer Response

θ (deg)	$\frac{V_o}{V_o \text{ max}}$	$\left(\frac{V}{E}\right)\left(\frac{V_o}{V_o \text{ max}}\right)$
0	0.707	0.707
5	0.771	0.711
10	0.821	0.711
15	0.868	0.710
20	0.903	0.701
25	0.934	0.702
30	0.954	0.700
35	0.977	0.702
40	0.987	0.701
45	1.000	0.707

indicated in Fig. 4 for the first quadrant only.

Mechanical Nonlinearity

Resistor R_B is the phase-shifter winding resistance for the first quadrant and the two similar resistors R_A are connected between the ends of the winding and the rotor. Solution of the network for the relation between the mechanical angle θ and the electrical angle ϕ is

$$\phi = \tan^{-1} \left[\frac{R_B/R_A + 90^\circ / (90^\circ - \theta)}{R_B/R_A + 90^\circ / \theta} \right]$$

The value of R_B/R_A which allows the closest equalization of θ and ϕ values is 0.5523. Using this value, the computed relationship between ϕ and θ is shown in table I.

The relationship between ϕ and θ over the range from 45 to 90 deg is similar. For many purposes, the error in equality between θ and ϕ can be neglected.

Commutation

To provide a continuously variable phase shift over a 360-deg range, the R_A resistors must be reconnected to different quadrant taps as the potentiometer is rotated. Alternately, four pairs of resistors can be permanently connected to the 90-deg tap points and the wiper must be connected in sequence to the resistor taps as the shaft is rotated. The latter alternative is accomplished by incorporating a four-segment commutator carrying a wiper attached to the potentiometer shaft.

To keep the output voltage magni-

tude fixed with shaft rotation a second linear potentiometer is used in the network shown in Fig. 5.

One complete rotation of the potentiometer in this amplitude potentiometer network will correct the amplitude response of one quadrant of the phase-shift potentiometer. The amplitude potentiometer is therefore driven through a four-to-one gear ratio from the phase potentiometer shaft. The amplitude response, measured as the ratio of output voltage to maximum output voltage for a constant input versus shaft rotation of the phase-shift potentiometer, is shown together with the product of the two response functions in Table II. The product of the response functions indicates the flatness of the overall response.

Packaging

The phase-shifting and amplitude-correcting potentiometers together with the necessary commutator and gear train are enclosed in a single compact case. The phase-potentiometer shaft is brought out to the main dial calibrated directly

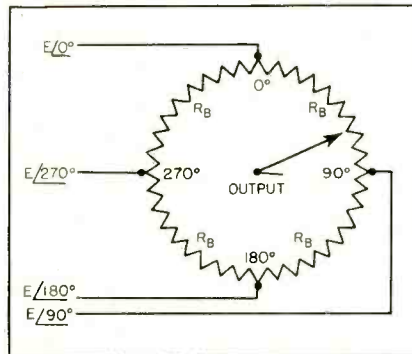

FIG. 3—Resistive phase-shifter is wire-wound potentiometer with taps at 90-deg intervals

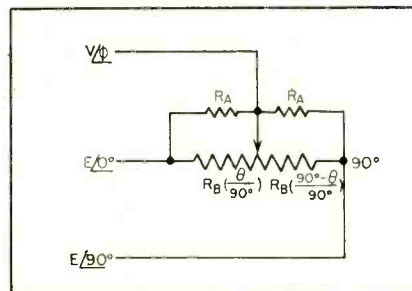

FIG. 4—Nonlinearity between electrical and mechanical angles is minimized by selecting proper R_B/R_A ratio

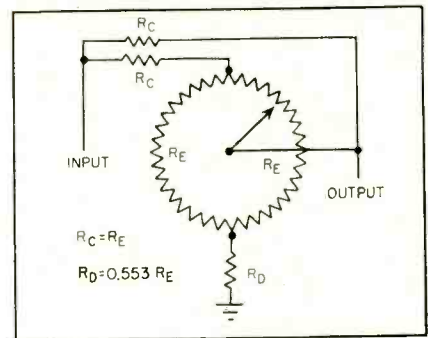

FIG. 5—Potentiometer corrects the amplitude response of one quadrant of phase-shift potentiometer

in phase angle and the amplitude potentiometer shaft is brought out in concentric fashion to provide a vernier control.

The overall voltage ratio between output voltage from the amplitude potentiometer and one of the quadrant voltages applied to the phase-shift potentiometer is 0.48. This ratio neglects the voltage loss in a conventional cathode follower used to couple the two potentiometers. The single-stage low-gain amplifier shown in Fig. 2 restores the output voltage level to that of the unshifted channel.

Use

A signal of the proper frequency derived from any convenient source is applied to the input terminals of the generator and the attenuator set for equal amplitudes as indicated by the balanced vtm. A single dial allows adjustment of the phase angle difference between outputs.

The accuracy of the phase setting depends primarily upon the linearity of the wire-wound phase-shift potentiometer. Accuracies of the order of ± 0.5 deg are feasible.

BIBLIOGRAPHY

- F. A. Everest, Phase Shifting up to 360 Degrees, *ELECTRONICS*, p 27, Nov. 1941.
- W. J. Brown, Wide-Angle Phase Shifter for Industrial Controls, *ELECTRONICS*, p 188, Mar. 1955.
- P. V. Rao, Phase Shifter Circuits Test Power Meters, *ELECTRONICS*, p 156, Jan. 1956.
- R. W. Hubbard and M. C. Thompson, Jr., Phase Generator for Tropospheric Research, *ELECTRONICS*, p 220, Oct. 1956.
- F. E. Terman, "Radio Engineers" Handbook", McGraw-Hill Book Co., Inc., New York, 1944.
- R. A. Bruns and R. M. Saunders, "Feedback Control Systems", McGraw-Hill Book Co., Inc., New York, 1955.

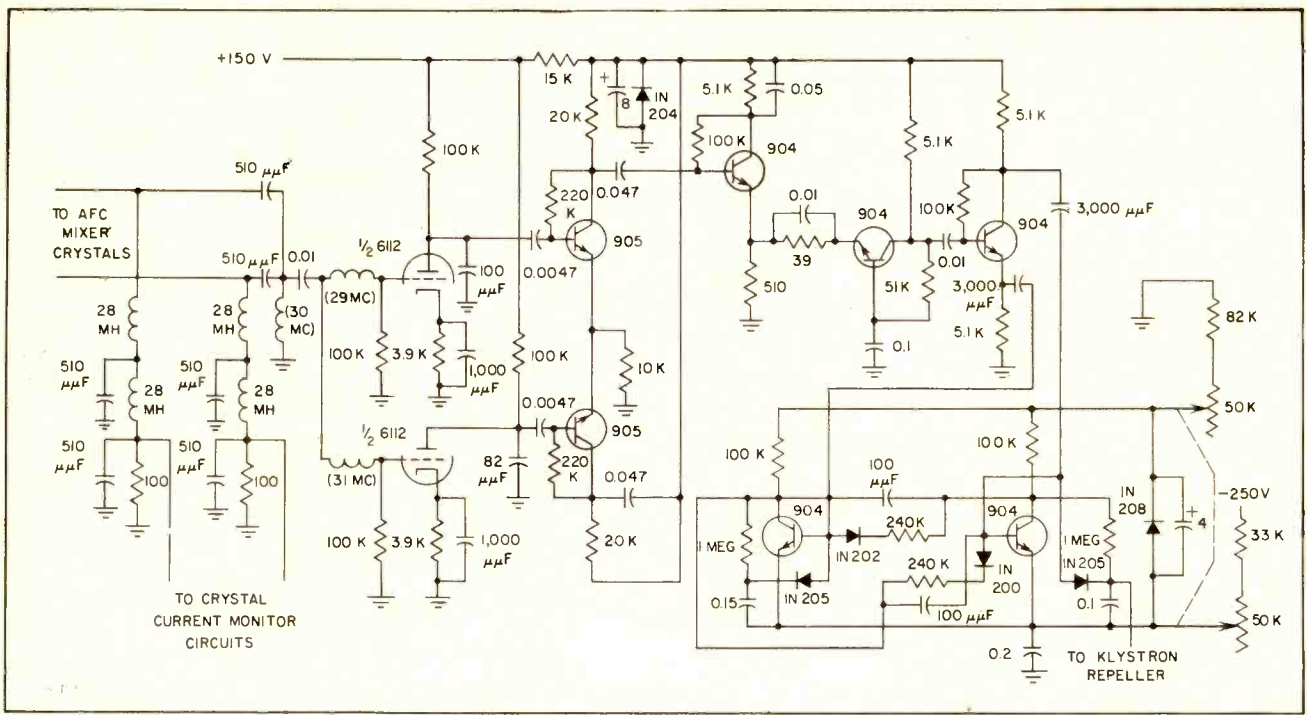

FIG. 1—Schematic of complete afc circuit. Unit has transistors and diodes throughout except for vacuum-tube discriminator stage

Transistorized AFC Uses

SUMMARY — Miniaturized plug-in unit for radar uses transistor multivibrator with Zener diodes. Search sweep varies local oscillator klystron repeller voltage, holding 30-mc i-f to bandwidth of 200 kc. Vacuum-tube discriminator feeds three-stage video amplifier triggering sweep generator. Low-voltage, low-power components afford greater reliability at less than half the power consumption of conventional vacuum-tube sawtooth systems

RADARS require afc systems to hold the difference frequency between the local oscillator klystron and the magnetron to the frequency of the i-f amplifier. Magnetron frequency variation may be due to pulling effects of scanning, while both magnetron and klystron frequencies will shift with power supply and temperature variations. The receiver bandwidth must pass the signal even if the magnetron frequency shifts. But, since the receiver performance is lowered as the bandwidth increases, the afc must hold the local oscillator to close limits, usually about 200 kc for a 30-mc i-f.

In the typical afc system, a small portion of the magnetron output is combined with the local oscillator output in a crystal mixer. The difference frequency is detected by a discriminator circuit. The detected signal passes through a differential amplifier and triggers a monostable multivibrator, which in turn stops the search sweep and thereafter corrects the local oscillator frequency at the repetition rate. A conventional afc unit consumes 10 to 20 watts in these functions.

Afc With Transistors

The semi-transistorized afc of Fig. 1 employs vacuum-tube detec-

tion because the low alpha cutoff of present silicon transistors yields a detected signal too greatly attenuated for practical use. The outputs of the two detectors feed the base of an emitter-coupled differential amplifier using two silicon transistors.

Output is taken from one collector to invert the signal from one detector and produce an S-type discriminator curve. The signal is fed to a three-stage video amplifier, using silicon junction transistors, whose output triggers a sweep generator. A common-collector stage matches the high impedance of the differential amplifier collector cir-

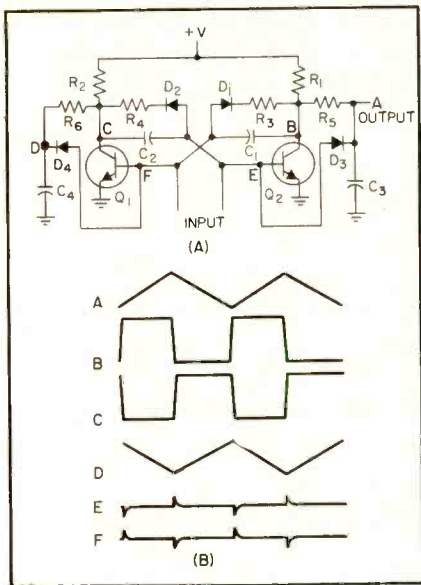
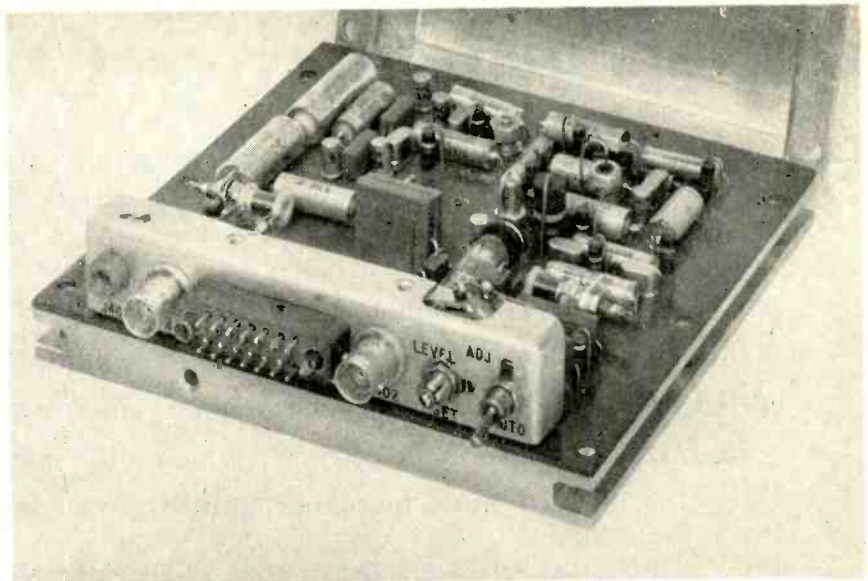

FIG. 2—Flip-flop circuit and waveforms



End-on mounting of some components is employed in plug-in unit

By H. H. HOGE and D. L. SPOTTEN

Air Arm Division
Westinghouse Electric Corp.
Baltimore, Md.

Triangular Search Sweep

cuit to the low impedance of the second video stage which has a common-base connection.

The output of this stage couples to the sweep generator through a split-load phase inverter. Manual adjustment of the repeller voltage is by the dual potentiometer. A range of about 55 volts insures full coverage of the klystron power mode. The sweep circuit and divider network draw less than 2 ma.

Basic Sweep Circuit

The sweep circuit of Fig. 2A comprises two transistors and four silicon diodes operating in the Zener region. Diode D_1 has a lower Zener voltage than D_2 and the current through R_1 , R_3 and D_1 saturates Q_1 , making point C only a few volts above ground.

Transistor Q_2 remains cut off, while point B is at a high potential and C_2 charges through R_1 and R_5 until point A reaches the Zener voltage of D_2 .

The current through D_2 then passes through the base of Q_2 to

produce an amplified negative signal at point B. This signal is fed through C_1 and amplified by Q_1 . The positive signal which appears at point C is then coupled back into Q_2 . The signal regenerates until the potential at C reaches the Zener rating of D_2 , thus locking the circuit with Q_2 saturated, point B a few volts above ground and Q_1 cut off.

Point C is now at high potential and C_1 charges through R_2 and R_6 until the Zener rating of D_1 is exceeded. Capacitor C_2 is simultaneously discharging through R_4 and Q_2 which is held in saturation. When the Zener rating of D_1 is exceeded the multivibrator will exchange status with C_1 , discharging while C_2 recharges.

The resulting triangular waveform is applied to the repeller of the local oscillator until a change in discriminator output is effected. This change in polarity is fed to the video amplifier and then to the correct base to stop the search sweep. As the charge on C_2 leaks off, the repeller voltage changes and

the resulting frequency shift is detected at the next pulse of the magnetron.

The sweep may be stopped at any point on the triangular search pattern. The range is set by the Zener diodes D_2 and D_1 . The response of network R_6 and C_2 at the repetition rate is such that the voltage swing at C, represents about a 200-kc change of the klystron frequency. The search sweep is therefore disconnected and the klystron is shifted only enough to see-saw across the i-f. between repetition rate pulses. This results in a lock-on saw-tooth sweep of about 0.2 volt p-p, which is well within the bandwidth of the receiver.

The loop is degenerative and tight enough to prevent false triggering due to stray radiation. The entire system uses approximately six watts. Assembled unit is less than 6 in. square, 2.5 in. high. Greater reliability and subminiaturization are therefore achieved through the use of low-power components with semiconducting devices.

Designing Oscillators

By SAMUEL N. WITT, JR.

Engineering Experiment Station
Georgia Institute of Technology
Atlanta, Georgia

SUMMARY — Frequency stability of oscillator types that can be divided into an amplifier and a feedback network is improved by design procedure that permits selection of proper geometry and elements of frequency-controlling network. Examples of oscillator circuits using transistors and designed by this method show increased stability by as much as a factor of 25

PAST APPROACHES in the design of vacuum tube and transistor oscillators have had as the principal object improved frequency and amplitude stability and/or greater output amplitude. The purpose of this article is to show how the frequency stability of most oscillators can be improved after a general oscillator type has been chosen. This method also provides for minimum harmonic distortion in the oscillator output.

This design procedure is applicable only to oscillator types which can be divided into two sections, an amplifier and a feedback network.

Stability Factors

For an oscillator with low distortion, two primary factors affect the ultimate frequency stability. The first is the change in phase shift in the amplifier portion of the oscillator when external parameters such as voltage and temperature are changed. The second is the frequency change required for equal and opposite phase shift change in feedback loop. These factors are interrelated because the total oscilla-

tor loop phase shift must be zero.

The block diagram of a feedback oscillator is shown in Fig. 1A. The amplifier is considered as its equivalent Thevenin generator with voltage $K\epsilon \angle \theta$ in series with a resistance, r_o , where r_o is considered a part of the feedback network. The input impedance of the amplifier is infinite since any reactive component may be canceled at any one frequency and voltage. The resistive component may be included as a part of R . Phase angle θ is a function of all external parameters such as temperature and voltage. It is assumed that θ has been made zero for the normal static condition of the external parameters. Constant K is a real, positive constant so no distortion of the waveform occurs.

Amplitude Limiting

If the frequency-controlling network is linear, the oscillator output will be a pure sinusoidal waveform. In most actual oscillators some distortion must occur so that amplitude limiting will result. However, by careful selecting the gain k of the feedback network this distur-

tion can be kept small so the assumption of no distortion will be substantially correct.

The primary factors affecting stability now becomes $\phi(f)$ and $\theta(s)$ where s is a general external parameter affecting the amplifier phase shift and $\phi(f)$ is the phase angle of the feedback network as a function of frequency. The objectives are to make $d\theta/ds$ as small and $d\phi/df$ as large as possible.

Several methods are well known for reducing $d\theta/ds$, thus, it is assumed that $d\theta/ds$ for the amplifier has already been made as small as possible.

Phase Angle

The factors influencing $\phi(f)$ are the geometry and element values of the frequency-controlling network. The choice of network geometry is limited only by practical values of K and r_o . For most amplifiers, r_o is much too large for use with practical feedback networks. Therefore, the use of transformers or coupling coils is usually necessary to obtain the desired impedances. If the values of K and r_o for the amplifier alone are compared with the values for the amplifier with the transformer, the quantity K^2/r_o will be found to remain constant. This is shown in Fig. 1B where K' and r_o' are the characteristics of the amplifier without the transformer. Either K or r_o may be selected for best performance with any particular feedback network, however, K^2/r_o must be held constant.

For a practical transformer-cou-

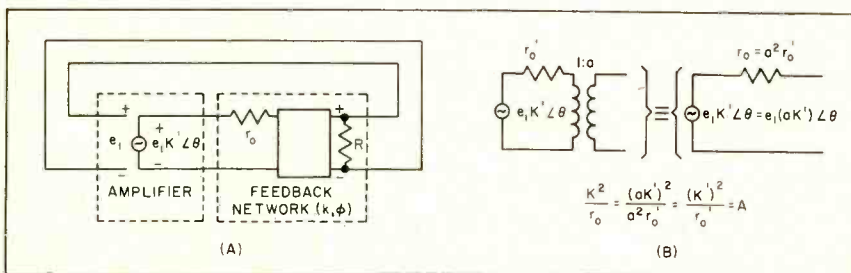

FIG. 1—Equivalent Thevenin circuit of feedback oscillator (A) is modified in (B) to show that the quantity K^2/r_o remains constant

For Greater Stability

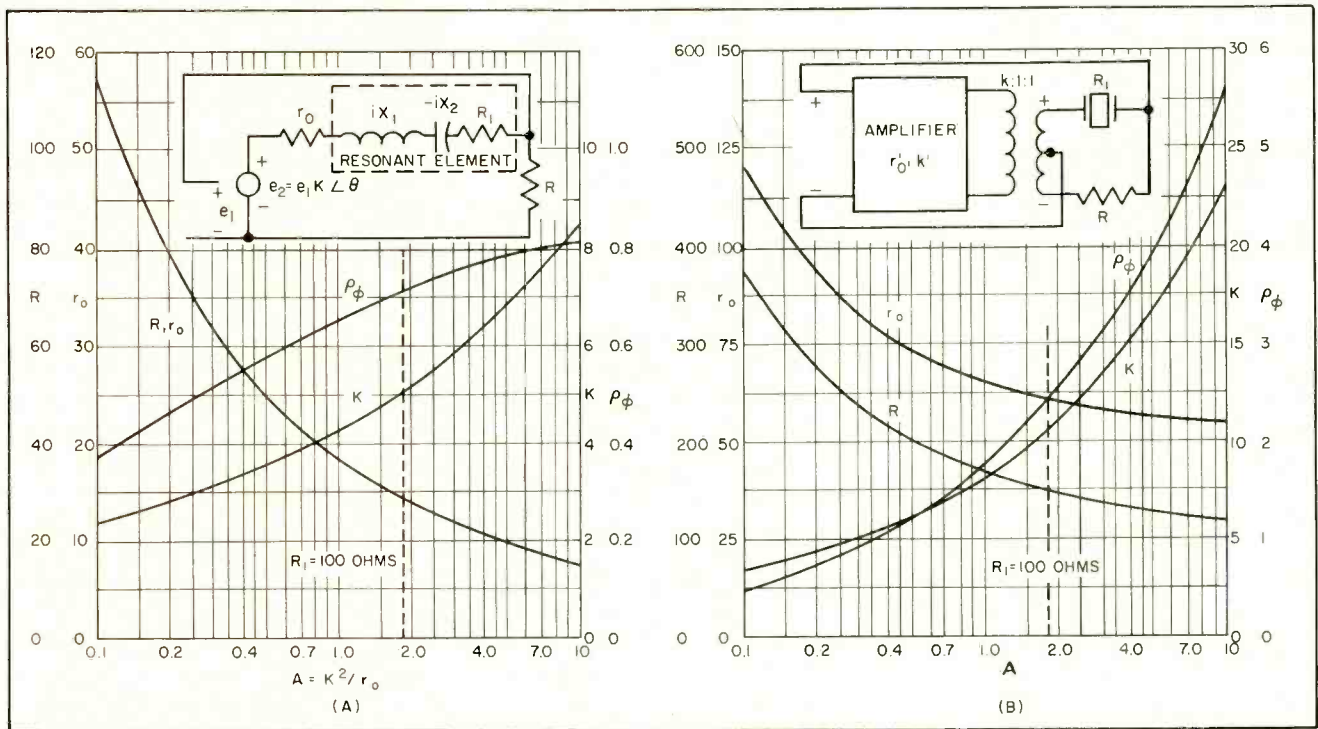

FIG. 2—Curves show the variation of circuit parameters for two different network configurations. Circuit and curves at right show what happens when the effective crystal Q is greater than its actual measured value

pled amplifier the transformer loss and phase shift should be included as part of the characteristics, $K \angle \theta$ and r_o . This is accomplished by measuring the amplifier characteristics with a representative transformer in use. The amplifier and transformer combination are then completely characterized in terms of $\theta(s)$ and $K^2/r_o = A =$ four times the available power output of the amplifier for one-volt input. Once A is known, the remaining problems are the selection of a frequency-controlling network configuration and the optimization of this network for best stability.

Network Selection

To optimize network values, consider the network shown in Fig. 2A. Here, the resonant element may be a series resonant L-C circuit or more appropriately, a quartz crystal. Any infinite amplifier input resistance may be considered as part of R . Amplifier parameters $K \angle \theta$ and r_o are both variable with the restriction that K^2/r_o is a constant.

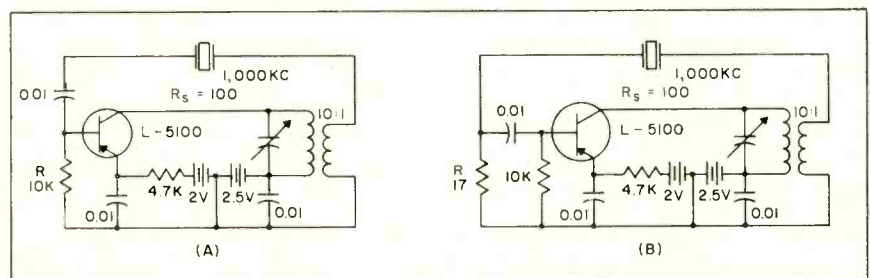

FIG. 3—Standard oscillator using surface-barrier transistor (A) has an instability of 100 parts in 10^6 . Circuit in (B), designed for impedance match between input and output of transistor, has stability of 13 parts in 10^6 .

For this network

$$jX = jX_1 - jX_2 \quad (1)$$

Then,

$$\frac{e_1/e_2 = k \angle \theta = k \angle \tan^{-1} X/(R + r_o + R_1)} \quad (2)$$

Equation 2 shows that near series resonance $d\phi/df$ increases as $(R + r_o)$ decreases. The object is to find the minimum value of $(R + r_o)$ that will permit oscillations thus making $d\theta/df$ as large as possible.

For $X = 0$,

$$R = (r_o + R_1)/(r_o^{1/2} A^{1/2} - 1) \quad (3)$$

$$R + r_o = [(r_o + R_1)/(r_o^{1/2} A^{1/2} - 1)] + r_o \quad (4)$$

The quantity r_o may be selected to make $(R + r_o)$ minimum by dif-

ferentiating Eq. 4 with respect to r_o . Thus $(R + r_o)$ is minimum when $2r_o^{3/2} A^{1/2} - 3r_o - R_1 = 0$. (5)

By substituting R_1 as determined from the resonant element chosen for the oscillator and A as determined by the amplifier into Eq. 5, r_o can be found. The curves of Fig. 2A show the variation of r_o with A as a parameter and with R_1 constant at 100 ohms. For each value of r_o and A constant K is determined from $K^2/r_o = A$. Resistance R is found from Eq. 3. The variations of K and R for $R_1 = 100$ ohms are also shown in Fig. 2A.

If r_o and R could both be made

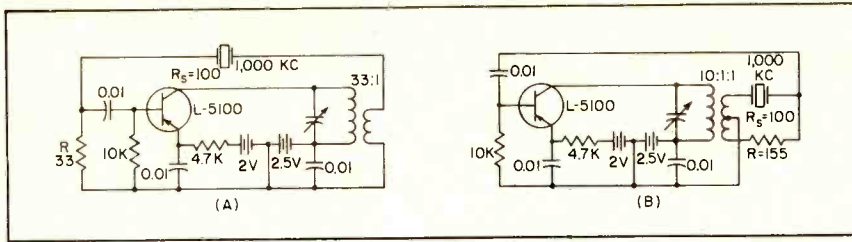

FIG. 4—Circuit in (A), designed from curves in Fig. 2A has instability of 8 parts in 10^6 while that in (B), designed from curves in Fig. 2B, has stability of 4 parts in 10^6

zero and still maintain oscillations, the change in frequency for a small amplifier phase shift, $\Delta\theta$, would be:

$$\Delta f = (\Delta\theta) (f_o) / 2Q \quad (6)$$

where Q is X_1/R_1 and f_o is $1/(2\pi\sqrt{LC})$ for the resonant element. For values of r_o and R other than zero, Eq. 6 must be modified by making Q equal to $X_1/(R_1 + R + r_o)$. The relative change in frequency for a practical circuit compared to the change for an unloaded resonant circuit for the same $\Delta\theta$ is

$$\rho_\phi = R_1/(R + r_o + R_1) \quad (7)$$

Thus, ρ_ϕ is a figure of merit for the network. If the values of ρ_ϕ are compared for two different networks, then the relative stabilities, $(S_v)_1$ and $(S_v)_2$, of oscillators using the two networks can be determined since

$$(S_v)_1/(S_v)_2 = (\rho_\phi)_1/(\rho_\phi)_2 \quad (8)$$

where the same amplifier and resonant element are used. Equation 7 expresses ρ_ϕ only for the network of Fig. 2A. For other networks, a similar expression for ρ_ϕ is needed.

Practical Circuit

To design a practical circuit to use the network of Fig. 2A, a suitable amplifier is first chosen. Parameter A is found experimentally. A suitable resonant element is chosen (crystal, series L-C circuit, or other). Resistor R_1 is determined from the resonant element. The correct value of r_o is then found from Eq. 5 and resistance R can then be found from Eq. 3. Reactance X as a function of frequency can be calculated for the resonant element. Then, ϕ as a function of frequency can be found from Eq. 2. If the amplifier phase shift θ is known as a function of voltage or temperature, then the frequency of oscillation as a function of voltage can be found by making ϕ equal to $-\theta$ for all voltages.

This method yields a theoretical stability which may be slightly better than can be obtained in a practical circuit since distortion has been neglected and R generally cannot be made as small as the value calculated in Eq. 3. If R is made exactly equal to the minimum value, when a phase shift occurs R may no longer be large enough to permit sustained oscillations.

Improvement in stability obtained by externally unloading the crystal R is found by first substituting the amplifier input resistance into Eq. 2 and calculating the stability then substituting R (minimum) into Eq. 2 and again calculating the stability. The ratio of the two stabilities is the improvement due to proper selection of R .

Network Configuration

This method is also valuable as a tool in choosing the constants for any particular feedback network.

It is possible with some networks for ρ_ϕ to be greater than unity, that is, the effective crystal Q is greater than its actual measured value. For example, the equations for the network shown in Fig. 2B are

$$K = 1 + \sqrt{1 + R_1 A / 2}, \quad (9)$$

$$R = [4K^2 + R_1 A (K + 1)] / A (K - 1) \quad (10)$$

and

$$\rho_\phi = 200(R + 2r_o) / [(R - R_1)(R + R_1 + 4r_o) - 1] \quad (11)$$

The curves of Fig. 2B show the variations of R , K , r_o , and ρ_ϕ for values of A from 0.1 to 10. Resistance R_1 is again chosen as 100 ohms. In designing oscillators the curves of Fig. 2B are used in the same way as the curves of Fig. 2A.

The importance of R_1 is not directly indicated by the equations for either network described. However, it can be shown that when the inductance and capacitance of the resonator remain unchanged, the frequency stability is increased as

R_1 is decreased. For example, using Eq. 9, 10 and 11 and a typical value for A of 2 results in values for $R_1 = 1000$ ohms, $\rho_\phi = 0.795$, for $R_1 = 100$ ohms, $\rho_\phi = 2.5$ and for $R_1 = 10$ ohms, $\rho_\phi = 7.1$.

When a quartz crystal is used as the resonator with the circuit of Fig. 2B an effective Q greater than that of the crystal alone can usually be expected. With the circuit of Fig. 2A, ρ_ϕ can never exceed unity, that is, no Q multiplication can occur.

Figure 2B makes no provision for the inclusion of a finite input impedance to the amplifier. For this condition, equations 9, 10, and 11 must be modified. Thus it is possible that the network of Fig. 2A might yield greater stability for a given amplifier and resonator.

Examples

A total of four transistor oscillators were constructed to illustrate this design procedure. An L-5100 surface barrier transistor was chosen for the amplifier because of its low power requirements and relatively high alpha cutoff frequency. The oscillator shown in Fig. 3A received no special design considerations. The component values were selected empirically and the selections were then modified as necessary to obtain oscillation.

The circuit shown in Fig. 3B was designed on the basis of an impedance match between the output and input terminals of the transistor. The only change in Fig. 3A required for this design was to replace R with a 17-ohm resistor.

The circuit in Fig. 4A was designed from the curves of Fig. 2. This required a change in the transformer turns ratio and also in the crystal terminating resistor as shown. The circuit shown in Fig. 4B was patterned after the block diagram in Fig. 2 and was designed using the curves of that figure. The instability characteristics of the oscillators were 100, 13, 8, and 4 parts in 10^6 frequency change for a one percent collector supply voltage change for the circuits of Fig. 3A, 3B, 4A and Fig. 4B respectively.

This work was supported by the Signal Corps Engineering Laboratories under Contract No. DA-36-039-sc-42712.

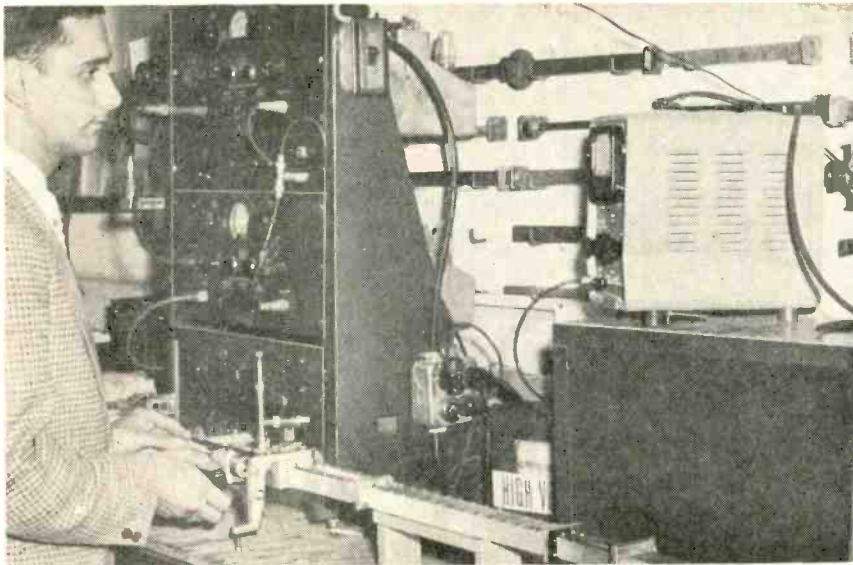

Setup at Technicraft Laboratories for proving transition performance

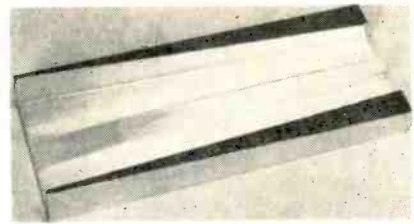

Internal machining of cutaway section

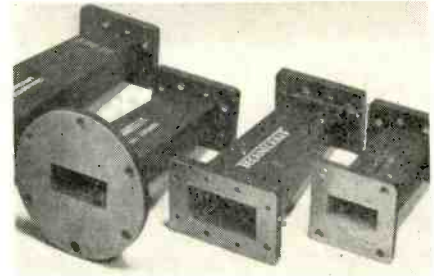

Typical graphically-designed transitions

Designing Tapered Waveguide Transitions

By BERNARD J. MIGLIARO*

*Director of Engineering
Microtech Inc.
Hamden, Connecticut*

SUMMARY — A procedure for designing well-matched transitions between different waveguides where the guide wavelength varies along the taper. Simple graphical method employs data presented here for double-ridge-to-rectangular transitions. Procedure may also be used for rectangular-to-rectangular or ridge-to-ridge tapered transitions with corresponding accuracy

MUCH HAS BEEN WRITTEN about tapered transitions between different types of transmission lines, but the common problem of designing a reasonably-matched tapered transition between waveguides in which the guide wavelength varies along the taper has not been extensively covered. This problem occurs in almost all types of tapered transitions between different waveguides. This article deals in particular with the design of transitions between various types of standard rectangular waveguides and double-ridge waveguides.^{1, 2, 3, 4}

To provide a smooth transformation from one impedance to another various types of tapers are employed. Three of the most common are exponential,⁵ gaussian^{3, 6} and more recently a taper which is the limiting case of an infinite number of quarter-wave transformers.⁶ All of these methods give reasonably-matched transitions provided the characteristic impedances of the transmission lines remain constant with frequency. But this is not true with waveguides except in the special case of a transition between rectangular units which have dif-

ferent narrow dimensions.

At any fixed frequency a taper can be designed using any desired variation of impedance along its length. If a taper is designed for optimum length and has a particular desired impedance variation along its length at the lowest operating frequency, as the frequency is moved toward the higher end of the operating band the originally-designed impedance condition will no longer exist.

At the same time, however, the

* Formerly with Technicraft Laboratories, Inc., Thomaston, Connecticut.

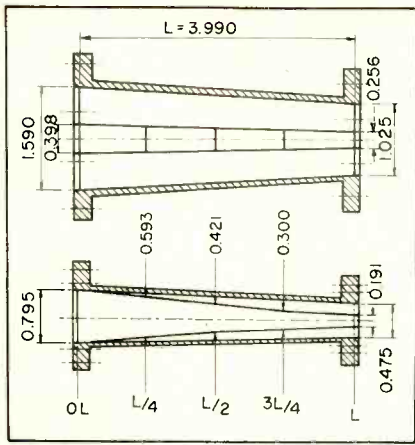

FIG. 1—Cross section of tapered transition from WR-159 rectangular to D-19 double-ridged guides

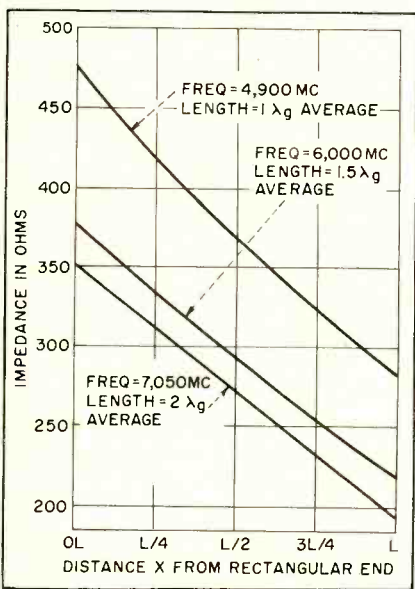

FIG. 2—Impedance characteristics of transition of Fig. 1, with exponential impedance taper at 4,900 mc

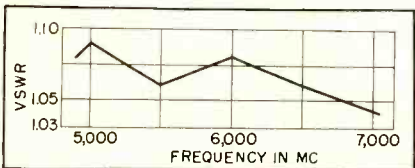

FIG. 3—The vswr characteristics of transition of Fig. 1

electrical length of the transition grows increasingly longer, making an optimum impedance variation along the taper much less important. These two effects tend to cancel each other, resulting in a transition which is electrically good over a wide band of frequencies.

Double-ridge Transition

This is illustrated by Fig. 2 and 3 for a transition between rectangular and double-ridge waveguides

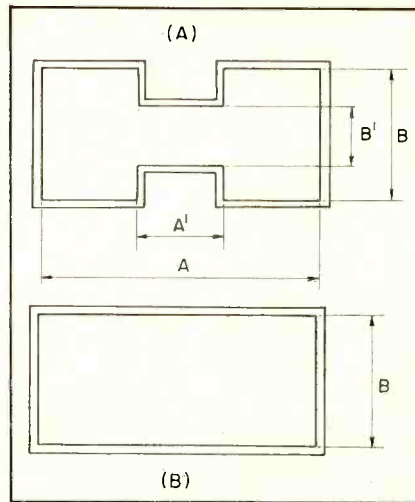

FIG. 4—Four double-ridge dimensions and two rectangular dimensions are employed in calculations

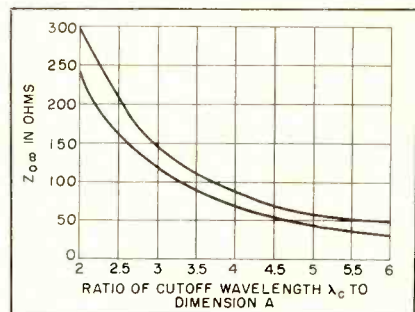

FIG. 5—Impedance variation of double-ridge guide with cutoff wavelength and dimension A for two values of B/A. In each case A'/A equals 0.25

shown in Fig. 1. Using this principle a procedure has been devised wherein transitions between double-ridge and rectangular waveguides can be designed quite simply with the aid of several graphs.

Characteristic Impedance

In the waveguide types shown in Fig. 4

$$Z_o = Z_{o \text{ inf}} (\lambda_o / \lambda_c) \text{ and } \lambda_c = \lambda_o / \sqrt{1 - (\lambda_o / \lambda_c)^2}$$

wherein Z_o is the characteristic impedance at any frequency; $Z_{o \text{ inf}}$ is the ratio of voltage across waveguide center to total longitudinal current on top face at infinite frequency; λ_o is the guide wavelength; λ_o , the free-space wavelength, and λ_c the cutoff wavelength.

The characteristic impedance of the double-ridge waveguide is a function of B/A , A'/A , B'/B and the operating frequency. The cutoff wavelength is a function of B/A , A'/A , B'/B as well as the A dimension. The characteristic impedance of the rectangular waveguide is

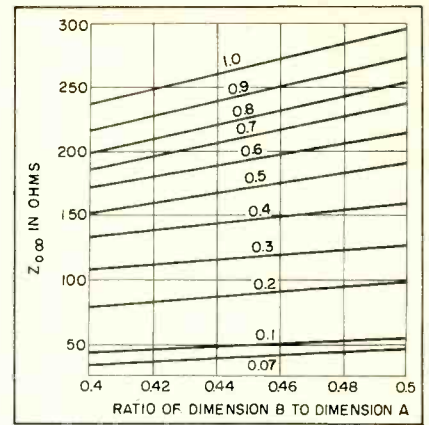

FIG. 6—Impedance variation of double-ridge guide with B/A. Figures on curves denote B'/B ratio

only a function of B/A and the operating frequency, and of course the cutoff wavelength is equal to $2A$. The curves of Fig. 5, 6 and 7 are all for a double-ridge waveguide with A'/A equal to 0.25. The rectangular waveguide is considered to be a double-ridge waveguide with B'/B equal to one.

Design Procedure

In the following procedure an exponential impedance taper was chosen, but the same method can be employed as well with any other type. For mechanical simplicity all dimensions except B' are linearly tapered mechanically from one guide to the other and the B' dimension is adjusted to provide the exponential impedance taper. Using the formulas given and the curves of Fig. 5, 6 and 7, Z_o and λ_o are found for both the double-ridge and rectangular waveguides at the lowest operating frequency. In order to plot the correct mechanical taper for B' this dimension must be found for at least several points along the taper. Finding this dimension at L , $3L/4$, $L/2$, $L/4$ and $0L$ is usually sufficient, although a greater number of points can be used if desired.

In the case of an exponential taper

$$\ln Z_{o,x} = \ln Z_{o_1} + x/L (\ln Z_{o_2} - \ln Z_{o_1})$$

wherein $\ln Z_{o,x}$ is the natural log of the impedance at any distance x from the rectangular end of the transition; Z_{o_1} is the characteristic impedance of the rectangular waveguide; Z_{o_2} is the characteristic impedance of the ridge waveguide and

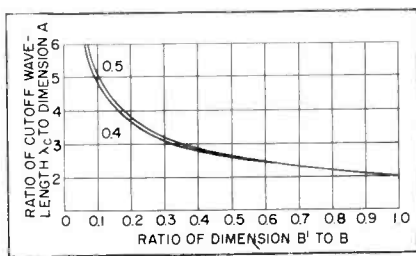

FIG. 7—Variation of cutoff-to-A ratio with B'/B . Figures on curves denote B/A when A'/A is 0.25

L is the overall length of the transition.

Using the values of Z_0 obtained from this equation, $Z_{0 \text{ infn}}$ is computed for various assumed values of λ_c/A for each of the chosen points along the length of the taper. $Z_{0 \text{ infn}}$ is given by the formula

$$Z_{0 \text{ infn}} = Z_0 (\lambda_0/\lambda_a)$$

Curves are plotted of $Z_{0 \text{ infn}}$ against λ_c/A for each of the chosen points using the same scales as used in Fig. 5 and the curves superimposed on Fig. 5. The points of intersection between these curves and the curve of $Z_{0 \text{ infn}}$ against λ_c/A for the proper B/A ratio gives the correct values of λ_c/A and $Z_{0 \text{ infn}}$ for each of the chosen points along the taper. Having found λ_c/A , λ_a for each point can be computed, and by using Fig. 7 the various values of B' can be found.

Mechanical Taper

Curves are then plotted of B' against x and λ_a against x . The first curve shows the mechanical taper for the B' dimension. In the actual machining this can be approximated by means of several straight lines. The curve of λ_a

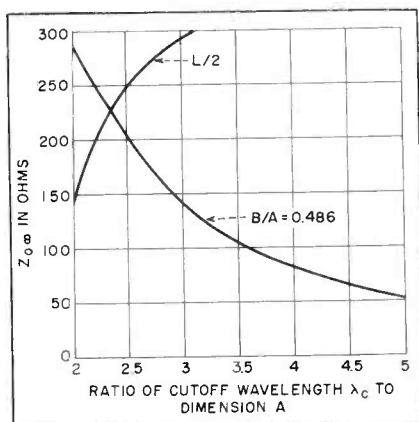

FIG. 9—Intersection of curve calculated for $L/2$ with that for B/A obtained from Fig. 2 shows 227 ohms impedance with cutoff-to-A ratio of 2.34

against x is graphically integrated and an average value of λ_a is obtained.

The length of the transition can be any integral number of half average wavelengths. A transition one average wavelength long is a reasonable compromise between convenient length and electrical performance.

WR-159 to D-19 Transition

Suppose it is desired to design a transition from WR-159 rectangular waveguide to D-19 double-ridge waveguide. The lowest operating frequency is 4,900 mc and the highest operating frequency is 7,050 mc. A table is constructed showing the parameters for various values of x as in Fig. 8. Figure 9 shows the manner in which the applicable values for $Z_{0 \text{ infn}}$ and λ_c/A can be determined. It is a plot of $Z_{0 \text{ infn}}$ for various assumed values of λ_c/A when $x = L/2$. The point of inter-

		WR-159 END				D-19 END
		OL	L/4	L/2	3L/4	L
I	A IN.	1.590	1.449	1.308	1.167	1.025
	B IN.	0.795	0.715	0.635	0.555	0.475
	B/A	0.500	0.494	0.486	0.476	0.464
	A'/A	0.25	0.25	0.25	0.25	0.25
II	Z_0 OHMS AT 4,900 MC	477	418	370	323	284
	$\ln Z_0$	6.17	6.04	5.91	5.78	5.65
III	λ_c/A	2.00	2.20	2.34	2.54	2.72
IV	λ_c IN.	3.180	3.140	3.060	2.960	2.780
	λ_g IN.	3.70	3.76	3.92	4.16	4.40
V	$Z_{0 \text{ infn}}$ OHMS	297	258	227	189	155
VI	B'/B	1	0.830	0.663	0.541	0.442
VII	B' IN.	0.795	0.593	0.421	0.300	0.191

FIG. 8—Typical table constructed for transition shown in Fig. 1. Data in group I is for a linear mechanical taper while that in group II is for an exponential impedance taper. Data in group III is derived from Fig. 5 and 7 and provides basis for computation of values in group IV. Values in group V are taken from Fig. 5 and those in group VI from Fig. 6. Group VII data is computed from groups I and VI

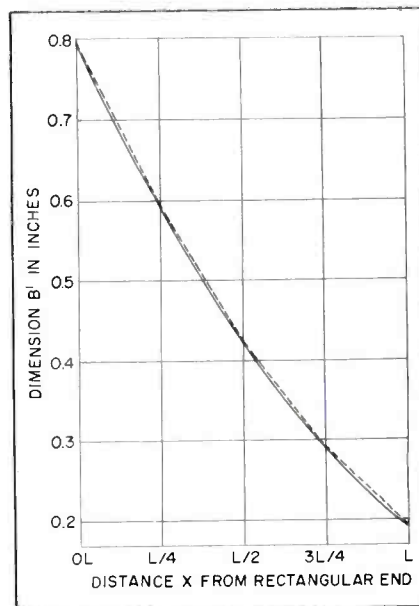

FIG. 10—Transition dimensions for exponential impedance taper at 4,900 mc. Curve is closely approximated by four broken straight lines shown

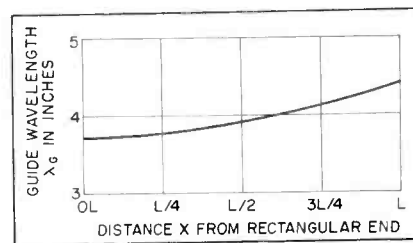

FIG. 11—Wavelength curve is graphically integrated and an average found, here 3.99 in. at 4,900 mc

section with the λ_c/A against $Z_{0 \text{ infn}}$ curve for $B/A = 0.486$ from Fig. 5 gives the correct values of λ_c/A and $Z_{0 \text{ infn}}$ for $L/2$.

Figure 10 is a plot of B' against x showing the approximation of the curve using four straight lines. Figure 11 is a plot of λ_a against x which is used for the graphical integration and gives an average λ_a of 3.99 in. at the lowest operating frequency. The actual length of the taper was made one average guide wavelength long.

REFERENCES

- (1) S. B. Cohn, Properties of Ridge Waveguide, *Proc IRE*, p. 783, Aug. 1947.
- (2) T. G. Mihran, Closed and Open Ridge Waveguides, *Proc IRE*, p. 640, June 1949.
- (3) S. Hopfer, Extremely Broad-Band Component Development, *Final Report 9.01*, Polytechnic Research and Development Co.
- (4) N. Marcuvitz, "Waveguide Handbook," McGraw-Hill Book Co., Inc., New York, 1951.
- (5) G. L. Ragan, "Microwave Transmission Circuits," McGraw-Hill Book Co., Inc., New York, 1948.
- (6) R. E. Collin, The Optimum Tapered Transmission Line Matching Section, *Proc IRE*, p. 539, April 1956.

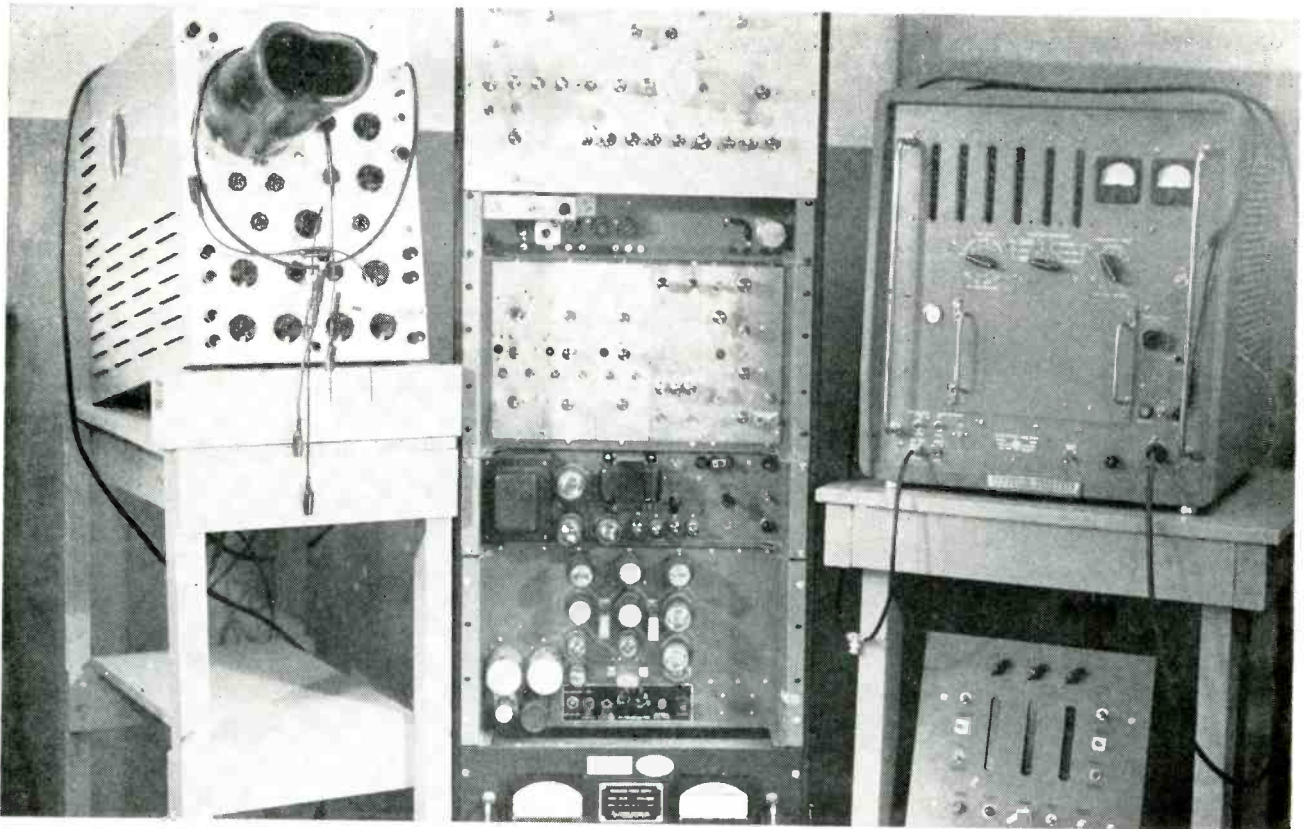

Setup used to test binary-decimal counter shown in rack at center. Ten-megacycle pulse-burst generator is at top of rack

Binary-Decimal Counter

By DONALD E. COTTRELL*

The Denver Research Institute
University of Denver
Denver, Colorado

MANY DECADE COUNTERS employ direct feedback schemes but the use of *and* gates provides feedback with isolation as well. The binary-decimal counter to be described produces one output pulse for every ten input pulses.

Code

Any number of input pulses that is not a multiple of ten will be stored in the counter binaries until the binary is reset. This counter is different from many decade counters since it makes use of the binary decimal 8, 4, 2, 1 code which is convenient, simple, and most compatible with many readout de-

vices currently used with digital machines.

The counter detects bursts of pulses of any pulse-burst width over a frequency range of 5 to 10 mc.

Logic

The block diagram of Fig. 1 shows that the counter would be similar to an ordinary binary counter with a scale of 16, except for the introduction of *and* gates *A* and *B* and a flip-flop in the last stage. The two *and* gates control the scheme of counting and effectively isolate the first binary from the second binary and flip-flop.

Before the arrival of any input pulses, the flip-flop is in the zero state; hence one input of *and* gate

A is high and the other input from the first binary is low. After two pulses are fed into the first binary, it generates one pulse which can pass through *and* gate *A* to the second binary. As yet no pulses can pass through *and* gate *B*, since the one state of the flip-flop is low.

Three more pulses are passed by *and* gate *A*, indicating an input to the counter of eight pulses. The flip-flop is now set to the one state by a pulse from the third binary, enabling *and* gate *B* to pass signals, but blocking *and* gate *A*.

Output Signal

After two more input pulses, or at the count of ten, *and* gate *B* generates a pulse that is the output signal of the counter. This pulse

* Now with Colorado Research Corporation, Denver, Colorado.

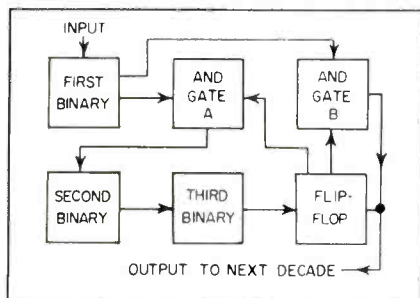
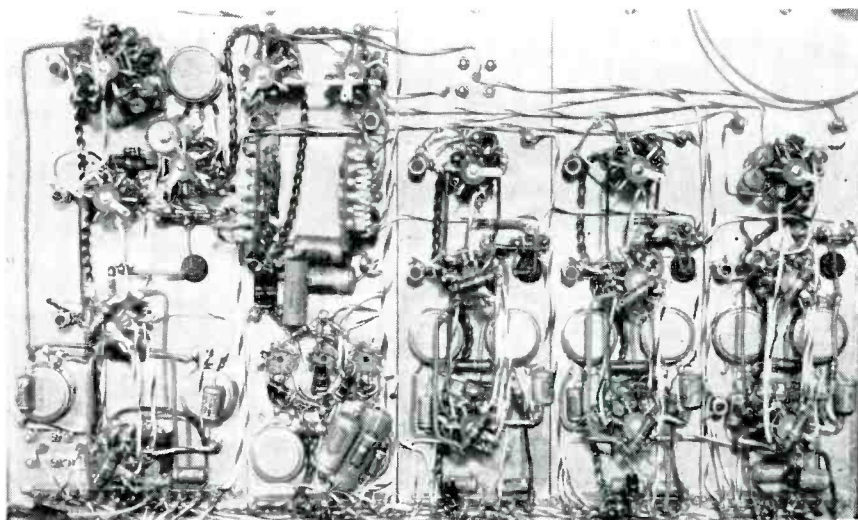

FIG. 1—Block diagram of counter. Use of *and* gates coupled with elimination of direct feedback makes high-frequency operation possible

Wiring side of counter shows, from left to right, first binary, and gates, second and third binaries and flip-flop



SUMMARY — Conversion from binary to binary-decimal form to facilitate application of computer output to readout device is made by counter using logical *and* gates in feedback loop. Design techniques, including use of isolation diodes, low plate voltage and grid-signal clamping, result in a rise time of 0.05 microsecond for the first binary circuit

Operates at 10 Mc

also resets the flip-flop to the zero state in readiness for the next cycle. Use of the *and* gates means that the resolution time of the rest of the counter is required to be only half as good as that of the first binary.² Also, the elimination of direct feedback and isolation by *and* gates permits operation at higher frequencies.

Counter Circuit

Figure 2 is the circuit diagram for the 10-mc binary decimal counter. The binaries and flip-flop of this counter use the basic Eccles-Jordan circuit with several refinements that contribute to better recovery time for the binary. It was desired to build a binary which would recover in 0.05 microsecond.

One refinement involves the use of a T-5 diode clamped to ground and a 68,000-ohm resistor returned to B+ on each of the inputs to the binaries and flip-flop. This has the effect of giving the input signal much better rise time, since the signal attempts to rise from -13 volts to B+, but is cut off at ground by the diode.

Diodes are connected to the grids of the binary and flip-flop tubes at the inputs to isolate them from external sources of transients. Grid-clamping diodes are also used to set the lower limit on input pulses at -3 volts and to keep the grid bias at a steady value.

Further sharpness of output signals of the binaries is obtained by a 15- μ H coil in series with the plate

resistance in the right half of each binary. This provides shunt peaking to yield a sharp plate signal which is 0.05 μ sec wide. The diode across the coil eliminates negative overshoot. The voltage divider network of the binaries and flip-flop, consisting of 24,000-ohm and 30,000-ohm resistors connected from each plate to B minus, provides for zero volts on the grids when the tubes are conducting.

Frequency Compensation

The 10 μ f speed-up capacitor in parallel with the 24,000-ohm resistor of the voltage divider is added for frequency compensation to allow rapid switching from one state to the other.

Figure 3 shows a burst of nega-

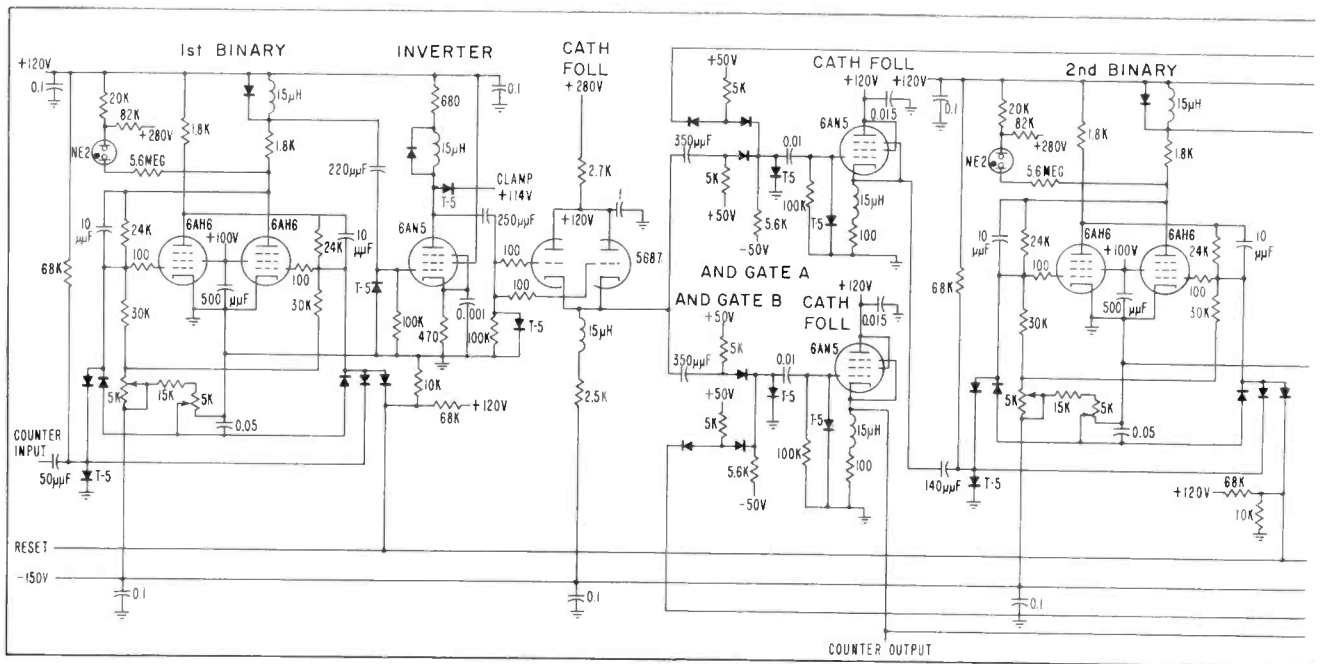

FIG. 2—Input pulses to the binary-decimal counter occur in bursts. Grid-signal clamping tends to eliminate bias change on the grids of

tive pulses typical of the counter input. Each pulse has an amplitude of 13 volts and is $0.05\mu\text{sec}$ wide. The width of such a pulse burst may vary anywhere from one or two pulses to a steady string of pulses over a frequency range of 5 to 10 megacycles.

Gating

The two *and* gates effectively isolate the first binary from the counter output, the flip-flop, and the second binary. The gating action is clearly shown for *and* gate A in Fig 4B. When the cathode follower of the zero-state flip-flop is on, as shown in Fig. 4A, *and* gate A gates four pulses from the first binary. The blank time of the waveform indicates that the zero-

state flip-flop is off.

Figures 4C and 4D show the gating action of *and* gate B. When the one state flip-flop is on, as shown by the negative signal in Fig. 4C, a signal from the first binary in coincidence with it will result in the counter output pulse of Fig. 4D.

Cathode followers are used extensively in the counter to provide driving power, isolation, and low impedance sources. The inverters of each of the binaries provide shunt peaking and amplify the signals to give sharp rise times.

Design Procedure

The main considerations governing the design of the binary circuit include: frequency of operation, type of input signal (steady state

or random pulse-burst) and the pulse recovery time of the binary.

The design of the binary circuit may be simplified into several steps.

Figure Of Merit

A tube is selected with a high figure of merit, which is g_m/C_T for R-C amplifiers. It is generally conceded this parameter is of greatest importance in obtaining the best recovery time.³ The transconductance g_m should be as high as possible at the operating point and the total capacitance C_T due to the tube and stray capacitance should be as low as possible.

Each half of the binary is designed as a separate R-C amplifier operating class C. A low plate supply voltage permits a small load re-

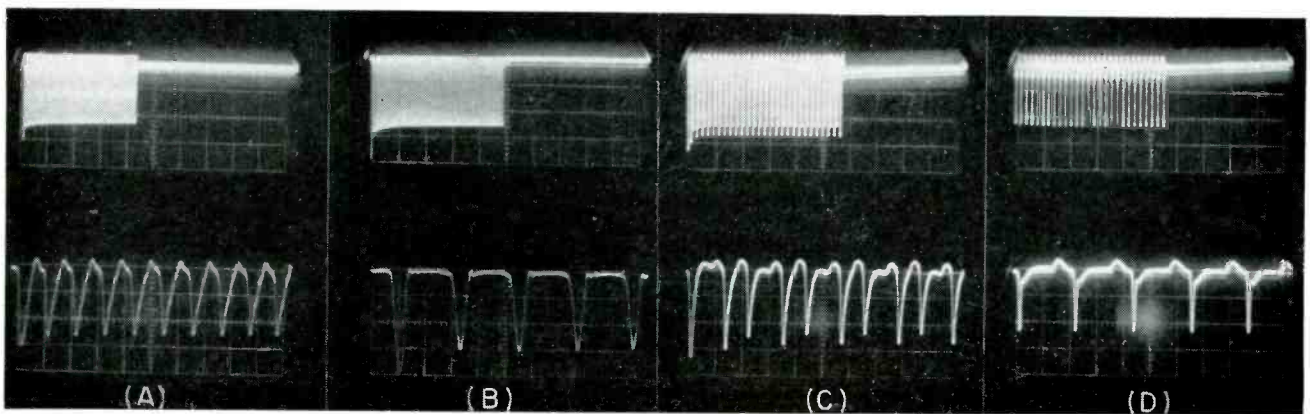
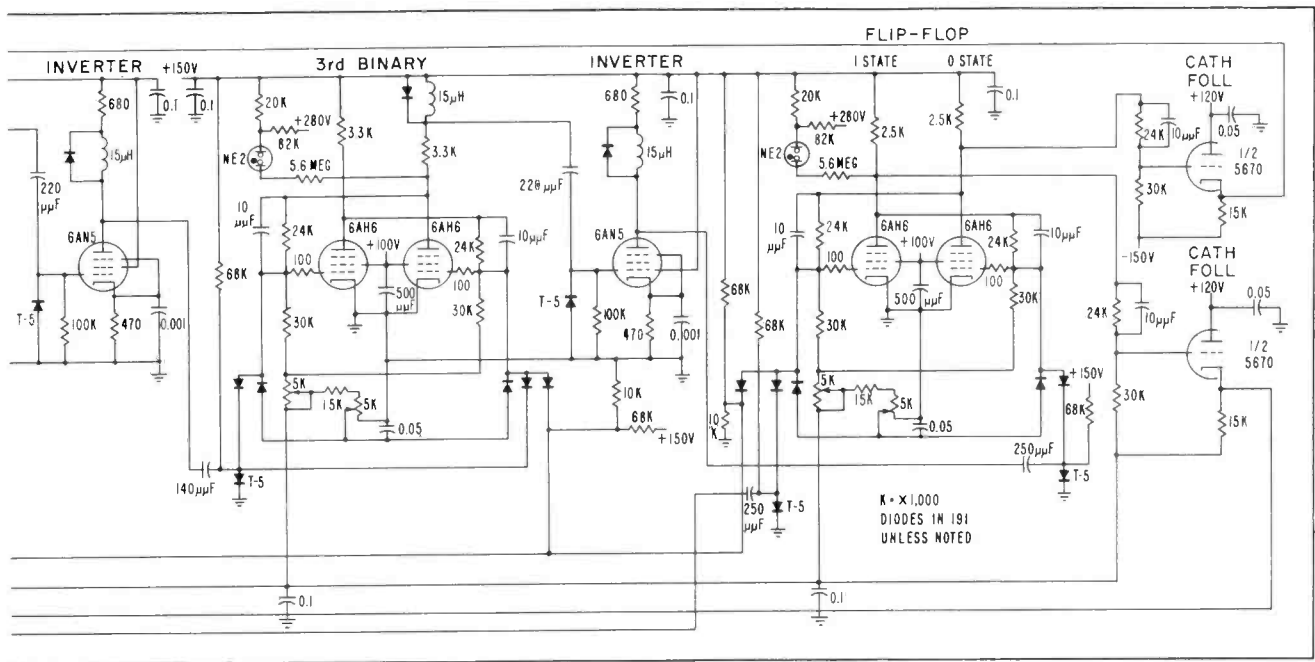

FIG. 3—Waveshapes show input pulse-burst to counter (A), output of first binary cathode follower (B), second binary inverter output (C) and third binary inverter output (D). Upper traces are displayed to a scale of $5\mu\text{sec/cm}$ while lower traces are at $0.1\mu\text{sec/cm}$ for (A) and (B) and $0.5\mu\text{sec/cm}$ for (C) and (D)



the counter tubes as a result of discontinuous characteristics of the input signal. Isolation diodes eliminate effects of external transients

sistance which is important for sharp rise time of the plate signal and high-frequency response of the amplifier.

Shunt Peaking

A coil is chosen to be placed in series with the right half load resistance for shunt peaking. The value of the coil inductance is determined by the formula'

$$L_b = mR_L^2 C_T$$

where m is the peaking parameter and R_L is the plate load resistance.

The resistance values of the voltage divider connecting the plate of the opposite tube to the grid B - are computed.

Frequency compensation for the upper resistance of the voltage

divider is provided because of tube input and stray capacitance. The compensation capacitance can be calculated by the formula derived from the transfer function of the voltage divider network

$$C_x = R_2 C_i / R_i$$

where C_x is the capacitance across the upper resistance, C_i is the tube and stray capacitance across the lower resistance, R_i is the upper resistance of the voltage divider and R_2 is the lower resistance of the voltage divider.

Isolation

The basic binary is designed by following the preceding steps and the final important step is to isolate it from external influences by using

germanium diodes. These are chosen for their low capacitance, high back resistance, low forward resistance, pulse recovery time and small size.

The author thanks C. Johnk of the University of Colorado and D. Dubbert of the Denver Research Institute. This work was sponsored by funds made available by the Denver Research Institute.

REFERENCES

- (1) R. K. Richards, "Arithmetic Operations in Digital Computers", D. Van Nostrand Co., Inc., New York, p. 179, 1955.
- (2) E. L. Kemp, Gated Decade Counter Requires No Feedback, *ELECTRONICS*, **26**, p. 145, Feb. 1953.
- (3) T. L. Martin, "Electronic Circuits", Prentice-Hall, Inc., Englewood Cliffs, N. J., p. 675, 1955.
- (4) T. L. Martin, "Electronic Circuits", Prentice-Hall Inc., Englewood Cliffs, N. J., p. 133, 1955.

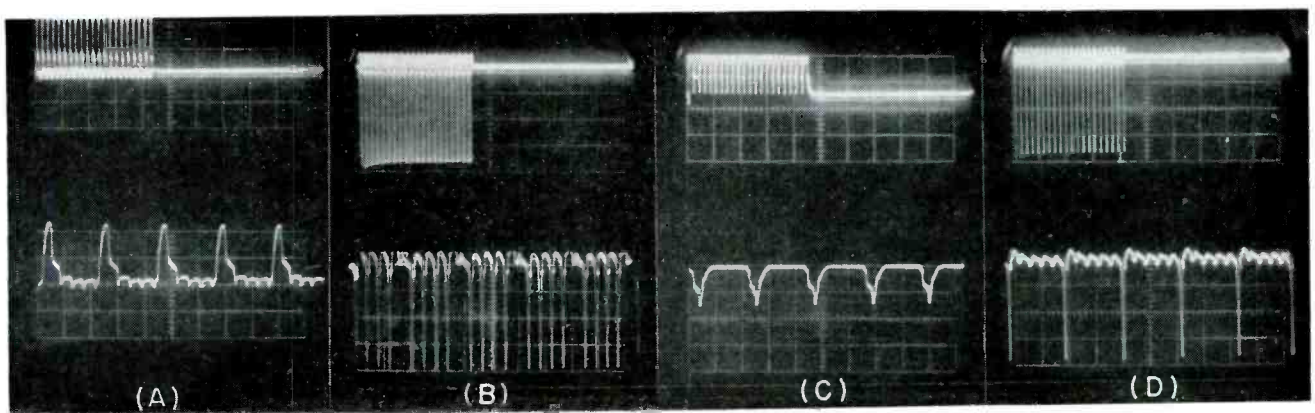

FIG. 4—Zero state of flip-flop is shown at (A) while (B) shows output of and gate A. One state of flip-flop (C) shows further count down. Output of and gate B (D) is also counter output. Upper traces are displayed to a scale of $5 \mu\text{sec}/\text{cm}$ while lower traces are at $0.5 \mu\text{sec}/\text{cm}$. A signal from the first binary in coincidence with the one state flip-flop results in an output pulse

Coaxial Line Impedance Chart

By HERBERT L. LEVIN

*Electron Tube Laboratory
Federal Telecommunication Laboratories
Nutley, New Jersey*

SUMMARY — Characteristic impedances of coaxial lines are related graphically to dielectric constants and the ratios of outer to inner conductor diameters. Dielectric constants of common materials are also tabulated

THIS CHART simplifies the solution for the characteristic impedance of a single coaxial line.

Example

If a characteristic impedance of 50 ohms is desired and the insulating material is air then from the chart the D/d ratio is 2.3. If metal tubing with an in-

side diameter $D = 0.250$ in. is chosen for the outer conductor, the outside diameter of the metal inner conductor is 0.109 in.

If a ceramic such as Alumina 95% with $K = 9$ were introduced as the dielectric and the Z_0 of 50 ohms were still desired, then

from the chart $D/d = 12.3$. If the D of 0.250 were also still desired, then $d = 0.020$ in.

The chart shows that if in this example d were not changed when the ceramic material replaced air, then Z_0 would drop from 50 to 16.5 ohms.

Table I—Dielectric constant K from 1 to 10,000 mc at 25C

CERAMICS		PLASTICS	
Alumina 85%	8.3-8.0	Bakelite	
Alumina 95%	8.9-9.3	BM 120	3.7
Alumina 97%	9.0-9.6	Epoxy Resin	3.1
Aluminum Silicate	5.5-5.2	Formica XX	3.6
Fosterite	6.2-6.0	Kel-F	2.3
Magnesium Silicate	5.9-5.3	Micarta 254	3.4
Steatite	6.5-5.3	Nylon 610	2.8
Porcelain, standard electrical	5.5	Plexiglass	2.6
Porcelain, zircon	9.2	Polystyrene	2.6
		Styrofoam	
		103.7	1.03
		Teflon	2.1
		Tenite II	2.9
		Vinylite	
		VG 5901	2.9
GLASSES		MISCELLANEOUS	
Corning 7052	5.1	Air	1
7070	4.0	Butyl Rubber	2.4
7720 Nonex	4.7	Mica	5.4
7740 Pyrex	4.6	Neoprene	
7900 Vycor (96% Silica)	3.8	38% GN	4.0
8871		Silastic 120	5.7
(Lead Potash) 9010	8.4	Silastic 152	2.9
(Lead Free) 9010	6.5		
Quartz, Fused	3.78		
Sapphire, Synthetic	8.6-10.6		

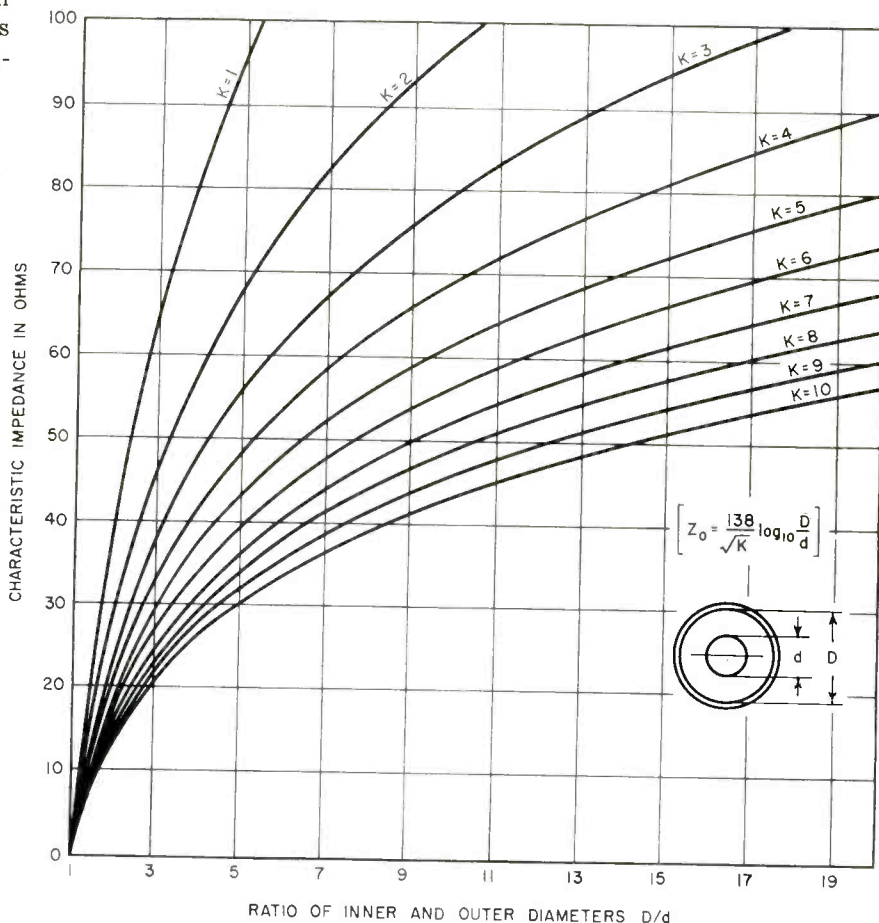
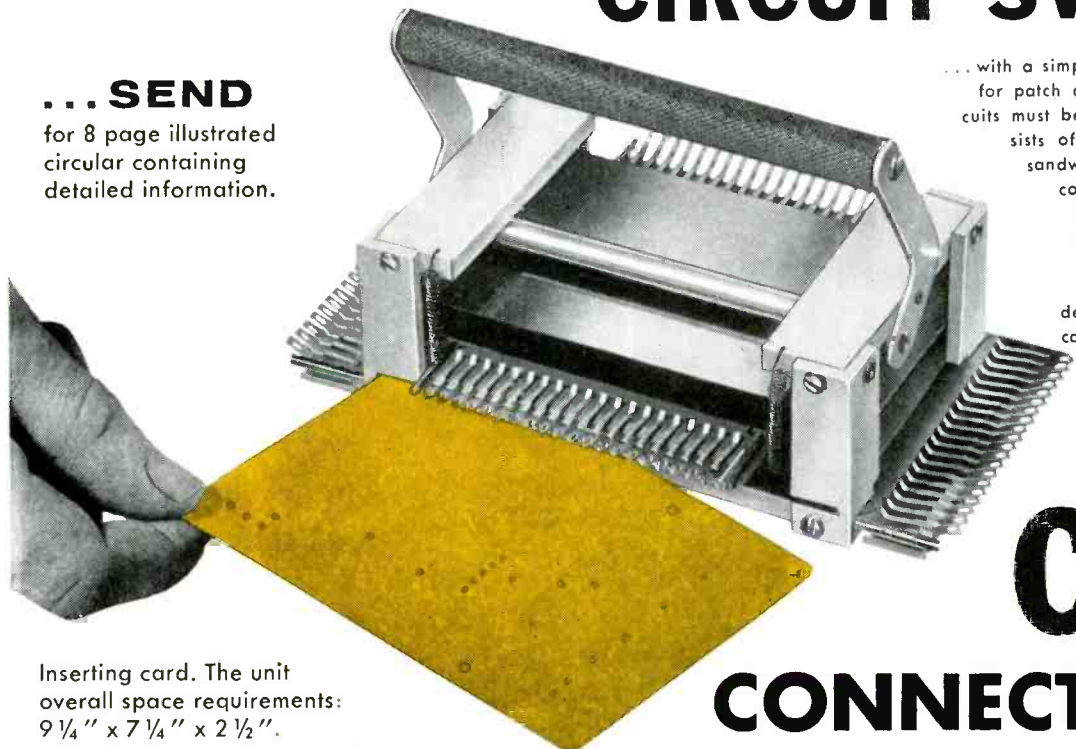

FIG. 1—Characteristic impedance of coaxial lines with various dielectrics

NOW... YOU CAN SIMPLIFY CIRCUIT SWITCHING

... SEND
for 8 page illustrated
circular containing
detailed information.



Inserting card. The unit
overall space requirements:
9 1/4" x 7 1/4" x 2 1/2".

... with a simplified circuit switching device that substitutes for patch cord panel systems in applications where circuits must be changed at random intervals. The unit consists of a molded block with 400 floating contacts sandwiched between two printed circuit boards. The contacts make connections between groups of strip conductors on the two printed circuit boards except where the punched card interposes an insulation. Perforations in the card permit connections to be made where desired and later changed by inserting a new card. Ordinary 3" x 5" cards are used, containing the 400 perforations in a 20 by 20 array. The contact blocks can be mounted in multiples for more complex circuits on larger printed circuit boards.

CINCH CONNECT-O-MATIC

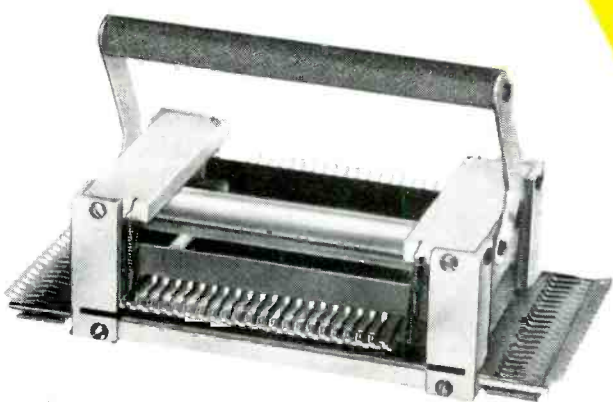

Open position. Lever is
disengaged and the card slot is open

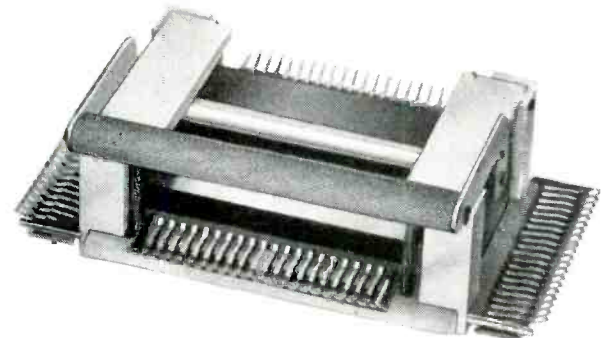

Closed position. The card has
been inserted (Top illustration) and the lever en-
gaged to close the unit, thus making the desired
connections.

Typical Switching Arrangement Possible with Cinch Connect-O-Matic.
The diagram represents vertical and horizontal backing plates realistically superimposed on one another. The gaps in the printed conductors are to electrically isolate different areas of the backing plates.
In this arrangement any of 8 leads in area A can be selectively connected to 12 other leads in this area; any of 10 leads in area B can be selectively connected to 5 other leads in this area; any of 5 leads in area C can be selectively connected to 8 other leads in this area; any of 6 leads in area D can be selectively connected to 15 other leads in this area; any of 2 leads in area E can be selectively connected to 5 other leads in this area; The dots shown represent a hole position in a typical punched card used with this arrangement.

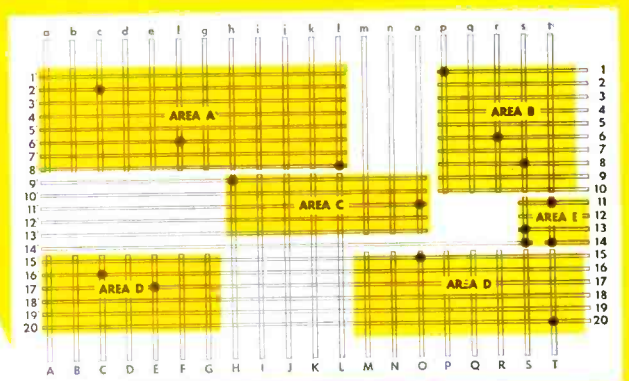

Centrally located plants
at Chicago, Illinois;
Shelbyville, Indiana;
La Puente, California;
St. Louis, Missouri

CINCH MANUFACTURING CORPORATION
1026 South Homan Ave., Chicago 24, Illinois
Subsidiary of United-Carr Fastener Corporation, Cambridge, Mass.

Parallel-T Nomograph

By DONALD F. CARTER

Chief Electrical Engineer
Harkins and Hershfield
Phoenix, Arizona

SUMMARY — Values of five parameters for parallel-T network are obtained directly with one setting of straightedge, for frequencies in audio and ultrasonic ranges, to expedite design of network used directly in amplifier chain to eliminate a single frequency. Same network can be used in negative feedback path to enhance a single frequency

THIS nomograph facilitates calculating parallel-T networks for experimental work in multiplex f-m equipment design. The subcarrier frequencies used are in the range from about 20 to 75 kc. With one setting of a straightedge, all parameters of the parallel-T network needed to eliminate the undesired frequency f may be obtained to three significant figures.

Example. If a specific frequency f of 10 kc is to be eliminated and C_1 is selected by the designer to be 100 $\mu\mu\text{f}$, run a straight-edge from 100 $\mu\mu\text{f}$ on the C_1 scale through 10 kc on the f scale. All other values can now be read directly from the nomograph. Thus, R_1 is 159,000 ohms, R_0 is 79,500 ohms and C_0 is 200 $\mu\mu\text{f}$.

Any two of the five parameters may be selected as the initial starting point of design. The other three can then be found with one setting of the straight-edge.

If the f scale is divided by 100, the C and R scales must be multiplied by 10. This changes the range of the nomograph to cover from 7 cps at the low end to about 2,000 cps at the high end.

For a 100-cps elimination network and a value of 1,000 $\mu\mu\text{f}$ for C_1 , these scale multiplying factors must be used. The other parameters are then $R_1=1.59$ megohms, $R_0=795,000$ ohms and $C_0=2,000$ $\mu\mu\text{f}$.

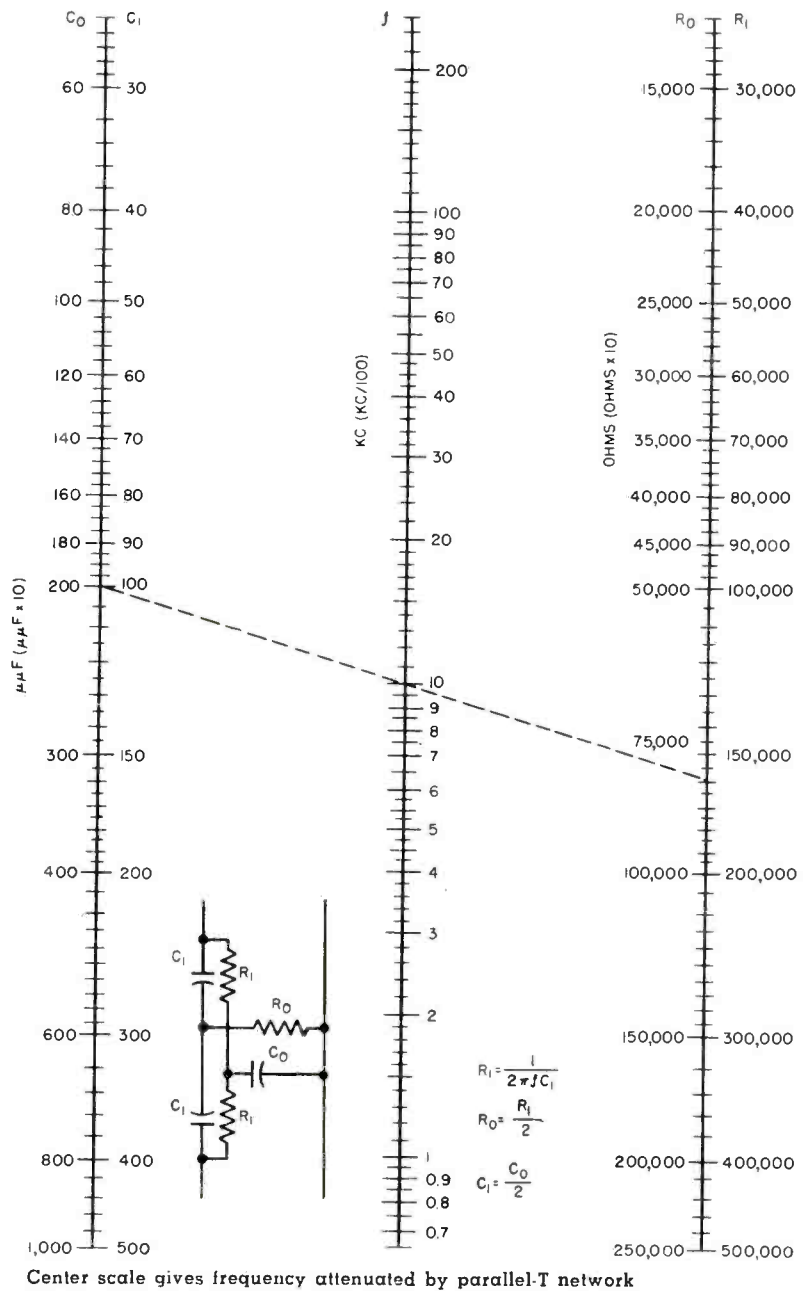

Center scale gives frequency attenuated by parallel-T network

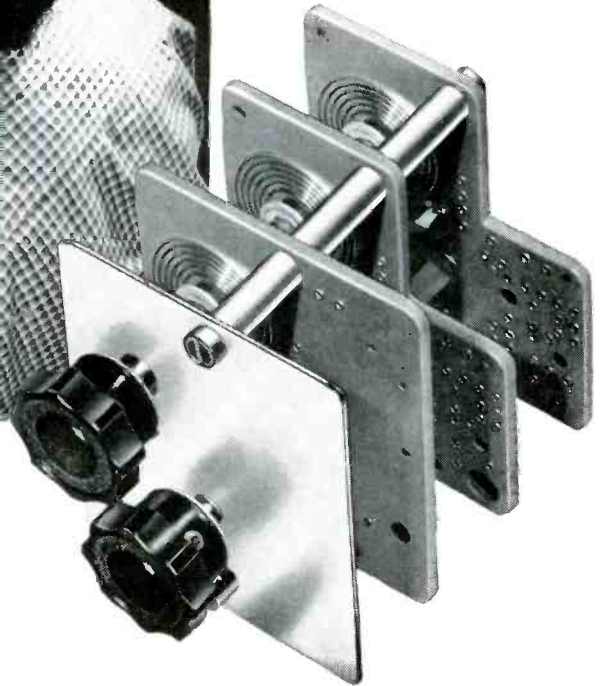
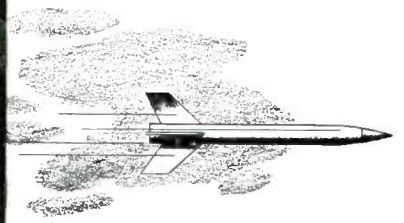

Call on the
Mallory

Electronic Assembly Department

for help in **Missile Guidance Systems**

Missile guidance systems are but one of the activities in which Mallory's Electronic Assembly Department can serve you. Extensive facilities and a highly skilled staff can produce single units or complete systems to your exact specifications.

The Electronic Assembly Department also maintains extensive laboratory programs for research and design—staffed with experienced personnel qualified to assume a major responsibility for the fulfillment of government or industrial assignments.

The development of efficient manufacturing tech-

niques, and the extensive training of production personnel, have brought about widespread acceptance of the department's abilities, recently recognized by qualification under the U.S. Army Signal Corps' RIQAP Program. The completeness of staff and facilities also offers the prime contractor many economic advantages.

Sales engineers may be contacted through Mallory district sales offices, or direct. Write for your copy of the Mallory brochure outlining the Electronic Assembly Department's facilities—or ask your local Mallory representative.

Serving Industry with These Products:

- Electromechanical** — Resistors • Switches • Tuning Devices • Vibrators
- Electrochemical** — Capacitors • Mercury and Zinc-Carbon Batteries
- Metallurgical** — Contacts • Special Metals • Welding Materials

Parts distributors in all major cities stock Mallory standard components for your convenience.

Expect more . . . get more from



Electrons At Work

Edited by DAVID A. FINDLAY

Electronic Equipment Water-Cooling

A cooling system developed by Martin Aviation for aircraft electronic equipment uses a shaped container to hold water in close contact with the tubes and transformers as shown in Fig. 1. The water is permitted to evaporate to control operating temperature.

Using this technique, tests have been conducted to determine cooling efficiency. Component temperatures have been held essentially constant at ambient temperatures from 150 C to 400 C.

Previous practice in cooling systems for electronics in high speed aircraft has been to duct either ram air or refrigerated air over the electronic equipment. Both of these methods involve power and apparatus since ram air must be cooled at higher speeds. Martin claims effective cooling at speeds as high as Mach 5 for the water cooling system as compared to a Mach 2.5 limitation on the other techniques. Volume saving obtained by the water cooling system are estimated at 64 cu ft for manned aircraft and about 1½ to 3 cu ft for missiles.

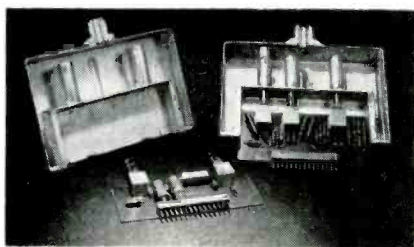

Water cooled electronic assembly used in tests

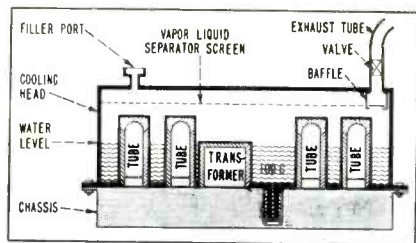
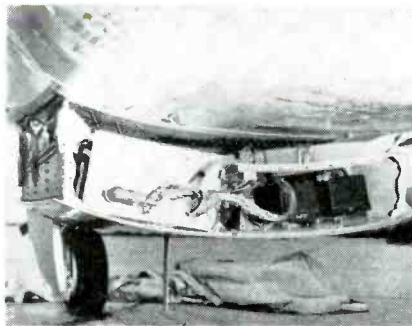
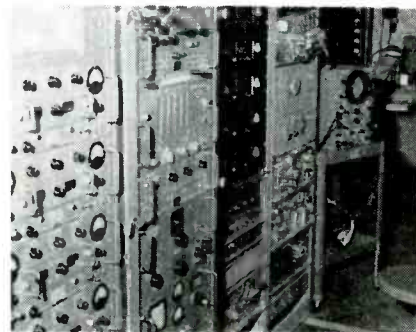

FIG. 1—Cross-section of chassis showing arrangement of cooling water chamber



Airborne end of telemetering system for ground display of airborne radar



Ground installation permits instructor to observe student's tactics

Radar Telemetering Trains Pilots

TELEMETERING equipment developed by the Air Research and Development Command is now being used to allow ground personnel to observe the radar display of an airborne jet interceptor during a training mission.

The new equipment will be used in training pilots for all-weather interceptor duty. Using the telemetering equipment, the instructor on the ground will be able to give voice instructions to the student

pilot and then observe his performance in a mock attack by observing the ground reproduction of the pilot's radar display.

► **Equipment**—The airborne and ground telemetering equipment is shown in the photographs. A modified oscilloscope is used as the ground display unit. Airborne equipment mounted in a bay under the plane body can be lowered for servicing.

Indicator Simplifies Color TV Tuning

BY A. A. GOLDBERG
CBS Laboratories, Inc.
New York, N. Y.

To sell color tv to the public, easy use of all viewer operated controls is essential. At present, this has not been achieved, particularly with regard to the fine tuning adjustment. A solution to this problem is the easily controlled, non-critical tuning indicator circuit discussed here.

► **Problem**—Although color receivers employ an intercarrier sound system similar to monochrome sets, the tuning is more critical because of the chroma subcarrier which is 3.58-mc away from the video car-

rier and 920-kc away from the sound carrier.

A typical color set has a main i-f amplifier frequency response of sufficient width to pass the video, chroma and sound carriers as shown in Fig. 1. Before reaching the video detector, the sound carrier is shunted off to its own detector. The balance of the i-f signal passes through a sound trap that brings the overall sound rejection to 50 db at the video detector. This heavy rejection is required to prevent a 920-kc interference pattern from appearing on the picture as a result of the chroma and sound carriers mixing in the nonlinear detector.

Sound rejection exists only when

it's

fast on
Performance
Reliability
and Quality

Kepeco

FOR VOLTAGE REGULATED POWER SUPPLIES

KR SERIES



MODEL
KR-16MC

OUTPUT VOLTS DC	6.3V AC	Model	Rack Mount			Price
			W	H	D	
0-150	Each supply	KR16	19"	12 1/4"	17"	\$625
100-200	has two	KR17	19"	12 1/4"	17"	\$625
195-325	15 Amp.	KR18	19"	12 1/4"	17"	\$695
295-450	outputs	KR19	19"	12 1/4"	17"	\$695

1.5 Amp.
KR
SERIES

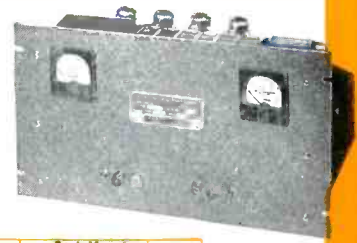

MODEL KR-8M

OUTPUT VOLTS DC	6.3V AC	Model	Rack Mount			Price
			W	H	D	
0-150	Each supply	KR 8	19"	10 1/2"	13"	\$330
100-200	has two	KR 5	19"	10 1/2"	13"	\$240
195-325	10 Amp.	KR 6	19"	10 1/2"	13"	\$240
295-450	outputs	KR 7	19"	10 1/2"	13"	\$250

600 ma.
KR
SERIES

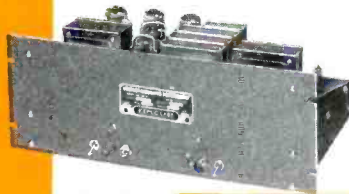

MODEL KR-4

OUTPUT VOLTS DC	6.3V AC	Model	Rack Mount			Price
			W	H	D	
0-150	Each supply	KR 12	19"	7"	11"	\$270
100-200	has two	KR 3	19"	7"	11"	\$180
195-325	5 Amp.	KR 4	19"	7"	11"	\$180
295-450	outputs	KR 10	19"	7"	11"	\$190

300 ma.
KR
SERIES



MODEL KR-1C

OUTPUT VOLTS DC	6.3V AC	Model	Rack Mount			Price
			W	H	D	
0-150	Each supply	KR 11	19"	7"	11"	\$180
100-200	has one	KR 1	19"	7"	7 1/2"	\$ 90
195-325	3 Amp.	KR 2	19"	7"	7 1/2"	\$ 90
295-450	output	KR 9	19"	7"	7 1/2"	\$ 97

125 ma.
KR
SERIES

To Include 3" Current and Voltage Meters, Add M to Model number (e.g. KR 16-M) and Add \$30.00 to the Price.
To Include Dust Cover and Handles for Table Mounting, Add C to Model number (e.g. KR16 C) and Add \$10.00 to the Price
To Include Meters, Dust Cover and Handles, Add MC to Model number (e.g. KR-16 MC) and Add \$40.00 to the Price

PRICES F.O.B. Flushing.

★ FAST RECOVERY TIME ★ GOOD STABILITY ★ LOW OUTPUT IMPEDANCE

Kepeco **KR** Voltage Regulated Power Supplies are conservatively rated and are designed for continuous duty at 50°C ambient.

REGULATION: Less than 0.2 volts for line fluctuation from 105-125 volts and less than 0.2 volts for load variation from 0 to maximum current.

RIPPLE: Less than 3 mv. rms.

STABILITY: The output voltage variation is less than the regulation specification for a period of 8 hours.

RECOVERY TIME: Less than 50 microseconds. The excursion in the output voltage during the recovery period is less than the regulation specification.

OUTPUT IMPEDANCE: Less than 0.1 ohms from 20 cycles to 100KC. Less than 0.5 ohms from DC to 20 cycles. Many units have very much lower output impedance.

featuring

- Fast recovery time, suitable for square wave pulsed loading.
- Voltage range continuously variable without switching.
- Either positive or negative may be grounded.
- Advanced vacuum tube regulator circuitry.
- Power requirements 105-125 volts, 50-65 cycles.
- Locking type voltage control AC, DC switches, fuses, and pilot lights.
- Terminations on rear of unit.
- Oil filled condensers.
- Color Grey Hammertone.
- Guarantee one year.

All models available
for 400 cycle operation
on special order.

SEND FOR BROCHURE B-576 — SPECIFICATIONS ON NEW MAGNETIC, TRANSISTOR AND TUBE VOLTAGE REGULATED POWER SUPPLIES AND SEMI-CONDUCTOR DC TO DC CONVERTERS



KEPECO LABORATORIES, INC.

131-38 SANFORD AVENUE • FLUSHING 55, N.Y. • INDEPENDENCE 1-7000

the sound carrier is positioned correctly in the sharp trap notch. Any misadjustment of the fine tuning control prevents rejection and results in a degradation of the picture. The average person finds it difficult to locate this critical point of noninterference.

► **Solution**—Simplification of the fine tuning adjustment is effected by use of a tuning indicator which permits correct positioning of the sound carrier in the sound trap notch and which is insensitive to other phenomena. This is accomplished by measuring the sound carrier energy at the point between the 41.25-mc sound trap and the video detector and then tuning the receiver for a minimum indication.

A schematic diagram of the tuning indicator and the affected portion of a conventional color tv is shown in Fig. 2. In operation, the 1N58 crystal detector is tuned to a frequency lower than 41.25 mc. by the variable inductance. When this occurs, the i-f response through the detector, shown in Fig. 3, becomes symmetrical to the sound notch causing a symmetrical indication to appear on the 6E5 tuning eye. The sensitivity control in the cathode circuit of the 6E5 is preset for best indicator operation. The receiver is correctly tuned when the shadow angle of the tuning eye is minimum. Since the shadow angle is a nonlinear function of the d-c

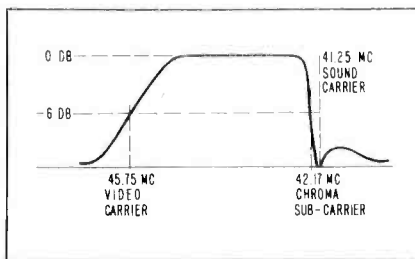

FIG. 1—Response curve for i-f section of typical color tv circuit

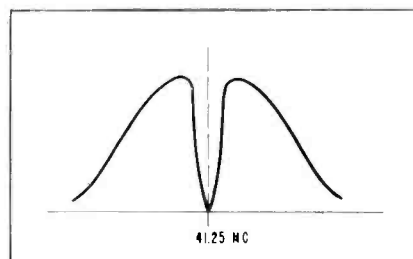

FIG. 3—I-F response curve for detector in tuning indicator

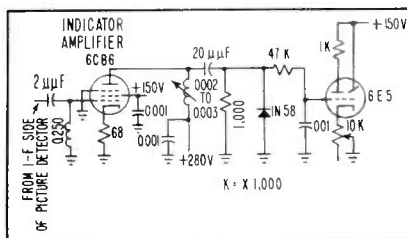
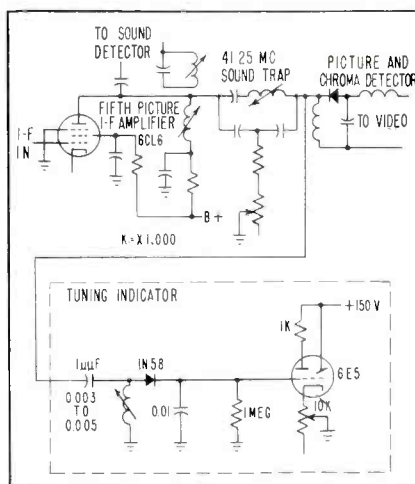

FIG. 4—Tuning indicator circuit with added amplification stage has increased sensitivity capable of operating at signal levels as low as 10 μ v at the antenna

FIG. 2—Tuning indicator circuit and a portion of associated color tv circuit showing method of connection to i-f section

control voltage, the greatest angular change with voltage occurs when the shadow approaches its maximum angle. Therefore, the sensitivity of the 6E5 is decreased as the sound carrier enters the notch and the indicator operation becomes less critical at small shadow angles.

Better operation is possible with

the circuit shown in Fig. 4. A stage of amplification is employed which improves the indicator operation on weak signals. Excellent results are obtainable with signal inputs between 10 μ v and 0.5 volt at the antenna terminals.

Coinventor of the tuning indicator is James Duggen, CBS Television.

Ridge Vane Antenna Provides Constant Beamwidth

BY WILLIAM A. SCANGA
Aircraft Armaments, Inc.
Cockeysville, Maryland

UNIQUE characteristics of new form of antenna permit its use in applications requiring constant beam width over a wide range of frequencies. A pair of vanes, extending from the open end of a ridge waveguide, acts as an end-fire antenna that violates the conventional relationship between beam width and frequency. Representative model tested had a one-half power beam width of 41 deg at 8.2 kmc and 43 deg at 11.0 kmc. An end-fire antenna operating under similar conditions has a beam width of

40 deg at 8.2 kmc, and 34.5 deg at 11.0 kmc.

► **End-Fire Array**—Given a linear array of isotropic radiators, infinite

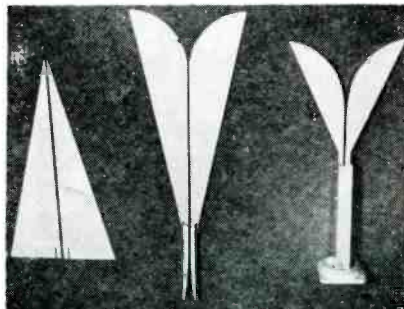

End-fire antenna configurations. Circularly-tapered fin is in center and exponentially-tapered form is at right

in number, over a finite length and assuming that the individual radiators are uniformly excited, but that the phasing is in accord with the phase velocity of a transmission line, the radiation pattern is

$$\gamma = \left| \frac{\sin[\pi(\rho \cos \theta - \beta)]}{[\pi(\rho \cos \theta - \beta)]} \right|$$

where γ = relative field strength

θ = angle with respect to the array axis

ρ = length of array in free space wavelength

$2\pi\beta$ = phase shift in radians in the feed line from one end of the array to the other end

The pattern described by this for-

CHOPPER APPLICATIONS



Servo Comparator

Where the difference between two voltages is required, a mechanical chopper develops such a signal. With a BBM chopper, the two voltage sources are isolated from each other. The error signal is modulated, the phase showing which voltage is the greater.

Type 313 for operation from -65°C to $+125^{\circ}\text{C}$ with NO derating

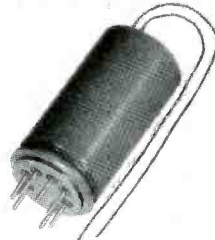

DC Amplifier

The mechanical chopper, because it has long-term stability, especially under fluctuating ambients, provides a simple and dependable means for modulating and demodulating DC signals for amplification in either vacuum-tube or transistor amplifiers.

Type 176 drive coil leads out top for minimum noise



Operational Amplifier

Wide-band DC signals, such as in analog computers and proportional controls, are readily amplified in a directly coupled vacuum-tube or transistor amplifier whose zero is stabilized by a mechanical modulator.

Type 800 double-pole double-throw for full isolation



Guidance System

For guided missiles and other equipments subject to shock and vibration, the balanced-armature chopper is used. This chopper has the electrical stability of other mechanical modulators, plus unusual resistance to external disturbances.

Type 351 operates normally during 15 G vibration at 10 to 2500 CPS



Analog-to-Digital Converter

In such applications as production test equipment where digital indications are desirable, a mechanical chopper samples the analog input. The equipment retains its calibration, there being no drift in the chopper.

Type 175 standard plug-in 60-CPS unit



DC VTVM

Because of its stability, the mechanical modulator is used in vacuum-tube voltmeters. In such applications the chopper extends the DC sensitivity into the microvolt region, an order of magnitude beyond that usually possible.

Type 300 standard miniature 400-CPS SPDT unit



AIRPAX PRODUCTS CO., CAMBRIDGE DIVISION, JACKTOWN ROAD, CAMBRIDGE, MARYLAND

The Front Cover

The group of geometric patterns on the cover suggesting some kinds of abstract design are made with two oscillators and an oscilloscope by Ben F. Laposky.

The oscillators are set to put out sine waves of around 11,000 cps, at 8 volts, for one input, and at 900 cps at 2 volts for the other input.

Interconnected phase-splitting networks produce circular or elliptical patterns when used individually. When operated together, the results are rosettes, or circles with loops. These patterns may be varied by slight changes in the frequencies or voltages of the oscillators, or other settings of the circuit controls.

Color is added to the trace by means of a rotating filter wheel in front of the cathode ray tube of the oscilloscope. The wheel is of lucite plastic, 17" in diameter, with six cellophane color segments, each 60 degrees, by about

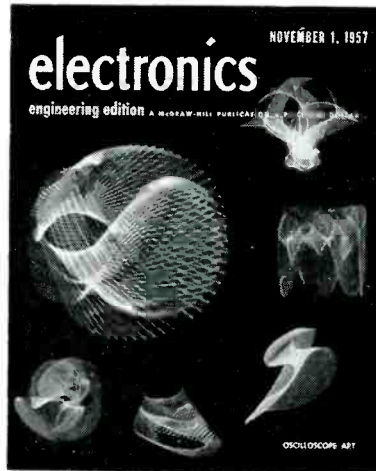

6" radially. There are two red, two green and two blue segments. The wheel is driven by a four-pole changer motor at about 900 rpm.

For the specific frequencies given, as well as the other settings, running the wheel at full speed produces good color effects, showing the three primary colors of red, blue and green in the loops, and some mixed colors, as yellow, purple and white.

metrically-tapered ridge, mounted in RG-52/U waveguide. All patterns given are E-plan patterns. While H-plane patterns were taken for most of the antennas, no attempt was made at analysis. For ridge widths of the order of 0.25 in. or less the H-plane pattern was essentially that of an open end of RG-52/U waveguide. For ridge widths greater than 0.25 in. the H-plane pattern deteriorates into a forward conical beam.

Antenna shown in Fig. 1 consists of two plates cut from 0.25 in. brass plate. An 0.075 in. gap between plates, extends from the open end of the waveguide a distance of 1.0 inch. From this point, the gap is exponentially increased until the gap equals the length (3.81 inches). The measured pattern at 9 kmc is indicated by the solid line in Fig. 1. The β was determined (by substitution into the radiation pattern equation that gives a power pattern that most nearly fits the measured pattern of the antenna. This pattern, for $\beta = 3.2$, is indicated by the dotted curve in Fig. 1. Since equation assumes uniform illumination and the actual antenna is probably not uniformly excited exact overlap of the two patterns was not achieved.

In addition to patterns at 9 kmc, both antennas described above were checked at 8.2 kmc and 11.0 kmc with the resultant pattern as shown in Fig. 2. As indicated, the pattern shape and width change very little with frequency.

Mobile Radar Uses Balloon Antenna

A TRANSPORTABLE radar installation uses a lightweight sectionalized housing and an inflatable aluminum coated reflector for the radar antenna. The system designed for the Air Force by Westinghouse can be deflated and packed into shipping containers. Packing in special airlift cases makes it possible to air-drop the entire installation.

The inflatable antenna is made from a vinyl-coated fiberglass fabric. For the assembled antenna two 30-ft diameter paraboloids are

mula is always symmetrical about the array axis, though not necessarily maximum along the axis. For β equal to ρ , the phase velocity along the feed line is equal to free space velocity, and the resulting pattern

is end-fire. For β slightly greater than ρ the pattern remains end-fire. As β is further increased, the pattern deteriorates into a forward conical beam. For β less than ρ the pattern is again a forward conical.

► **Experimental Results** — Experimental data have been obtained at 8.2, 9.0, and 11.0 kmc. All of the antennas were fed from a sym-

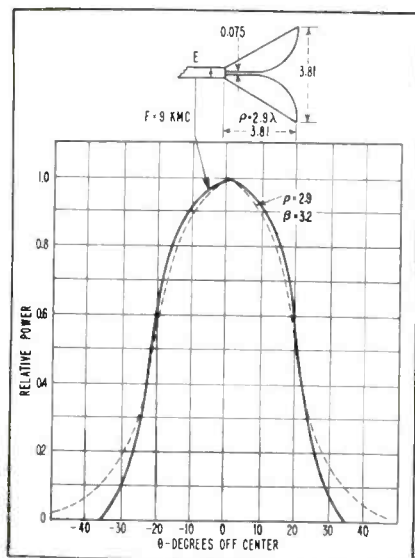

FIG. 1—Pattern of exponentially tapered antenna with theoretical pattern

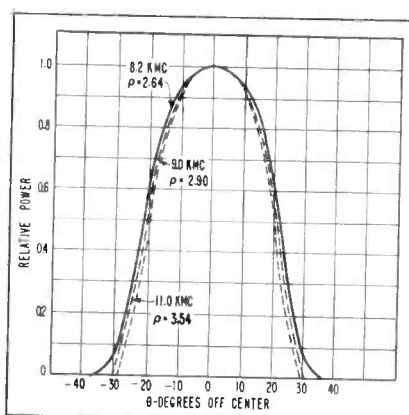
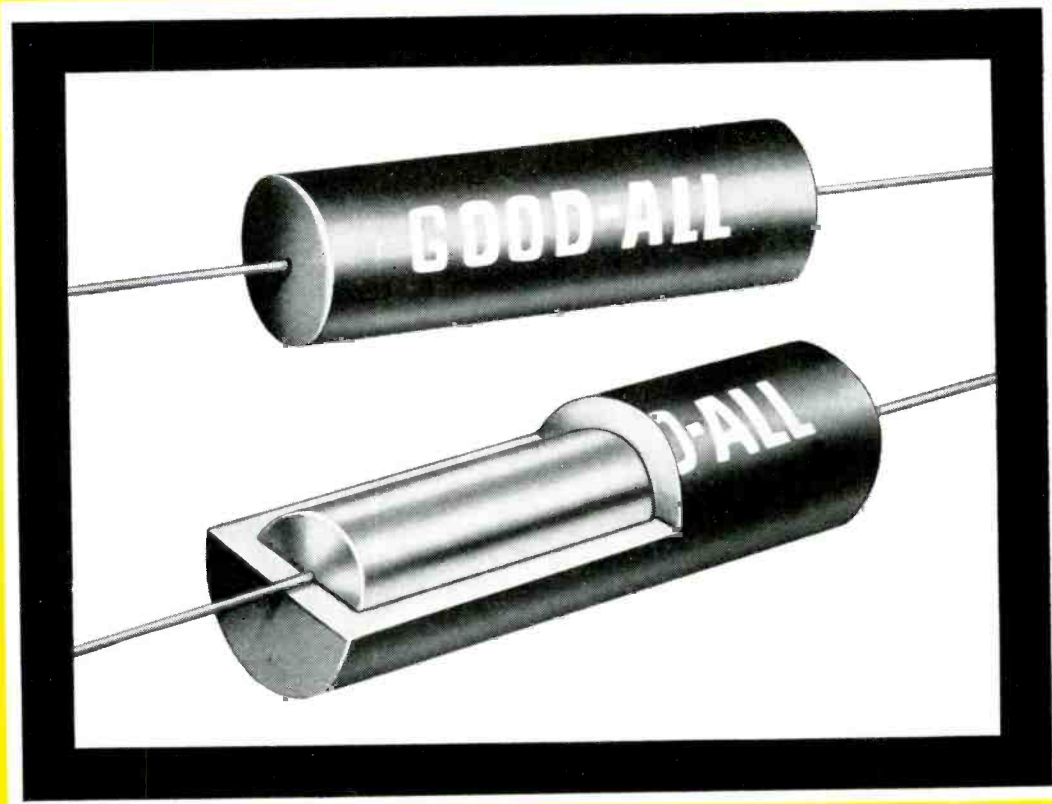

FIG. 2—Patterns of exponentially-tapered antenna taken at 8.2, 9.0 and 11 kmc.

EPON[®] RESIN does it !

Improved GOOD-ALL capacitors have low leakage, high stability—even in extremely humid climates



Here's how:

EPON RESIN is helping to set new standards of excellence in a line of 600 UE capacitors made by Good-All Electric Manufacturing Company, Ogallala, Nebraska.

Good-All reports that Epon resin offers superior moisture resistance . . . far better humidity protection than obtained with

conventional molding materials. These capacitors offer rugged, trouble-free performance because Epon resin assures high dielectric strength, low leakage, great resistance to chemical and corrosive attack, and handsome appearance.

For molding . . . for potting . . . for laminating, sealing and encapsulating . . . Epon resins are pre-

ferred because they offer an almost ideal combination of electrical and physical properties.

• • •
Write for complete information on the use of Epon resins in protective enamels, tool and die materials, etched circuit laminates, transformer and motor sealing compounds.

SHELL CHEMICAL CORPORATION

CHEMICAL SALES DIVISION, 380 Madison Avenue, New York 17, New York

Atlanta • Boston • Chicago • Cleveland • Detroit • Houston • Los Angeles • Newark • New York • San Francisco • St. Louis
IN CANADA: Chemical Division, Shell Oil Company of Canada, Limited • Montreal • Toronto • Vancouver



For PILOT LIGHTS

CONSULT

DIALCO

Your product benefits 3 ways from the use of a DIALCO Pilot Light:

Enhanced appearance: The glow of light and sparkle of a lens add colorful visual attraction.

Greater safety: A timely warning flashed by a pilot light can prevent damage to equipment.

Added service: Discs inserted behind lenses can be used to deliver specific messages, such as "FUEL LOW", "ON", "OFF", etc.

Let the Dialco engineering department assist you in selecting the right lamp and the most suitable pilot light for your needs.

Dialco offers the complete line of pilot lights, from sub-miniature types to giant units with 1½" lenses.

Every assembly is available complete with lamp.

SAMPLES ON REQUEST AT ONCE — NO CHARGE

Illustrations are approx. 70% actual size... (A) No. 8-1930-111 sub-miniature pilot light... (B) No. 521308-991, with multivue cap... (C) No. 922210-111, dimmer type... (D) No. 47901 with light shield cap.

Write for latest catalogues and Design Brochure.



Foremost Manufacturer of Pilot Lights

DIALIGHT CORPORATION

60 STEWART AVE. • BROOKLYN 37, N. Y.

HYACINTH 7-7600

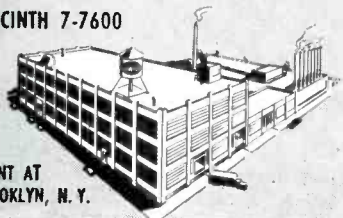

PLANT AT BROOKLYN, N. Y.

Circle 81 Readers Service Card

ELECTRONS AT WORK

(continued)

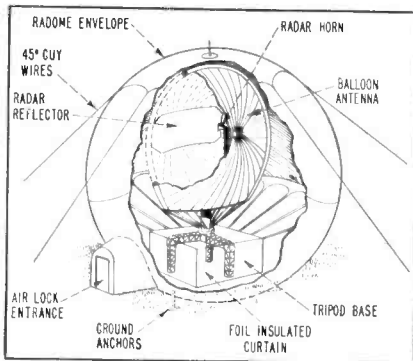

FIG. 1—Structure of radome and inflatable antenna for transportable radar station designed for military use

joined at their rims and inflated to less than 0.02 psi. This structure is then joined to a 16 in. diameter tubing that attaches to the rim of the two paraboloids. The tubing, inflated to 10 psi, acts as a stabilizer for the structure. The entire antenna system weighs 1,690 lb.

A sheet of Mylar, coated with aluminum by vapor deposition, is attached to the inside surface of one of the paraboloids. This is used as the reflector. The fiberglass fabric passes r-f energy with little attenuation.

► **Radome**—The protective housing for the radar antenna and electronic equipment is supported by air at a pressure of 0.17 psi. It is sectionalized into five side panels and one crown piece for transportation and erection. The complete radome assembly weighs about 1,400 pounds.

Both the radome and antenna are kept above surrounding air-pressure level by blowers. Capacity of



Deflated antenna and supporting structure ready for packing

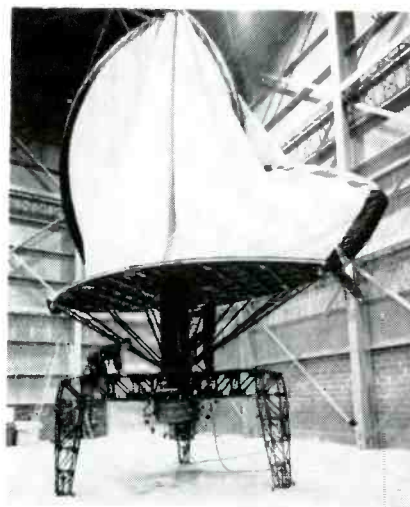

Partially inflated antenna being checked as blowers are started

the blowers is such that more than fifty 20-mm projectiles can pierce both antenna and radome without affecting normal operation.

Dielectric Recorder Uses Simple Pickups

IN dielectric recording, information is stored as a surface charge on a rotating dielectric-coated drum. For some applications this technique has advantages over magnetic recording.

As shown in Fig. 1, the audio signal is stored as a space-varying surface charge on the drum. The charge is transferred to the drum through a conducting path of ionized air produced by a stable r-f corona discharge. As the drum passes through the discharge region, it is charged to the average potential of the re-

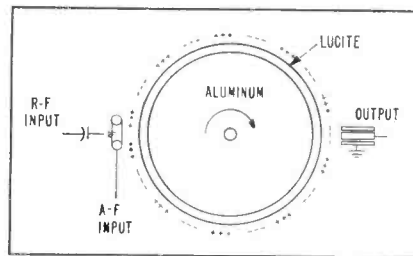

FIG. 1—Dielectric recording system

gion which is the instantaneous value of the audio signal.

Outside the discharge region, only volume and surface leakage in the

now! 400 mA
600 volts PIV

in a glass package

immediately available in production quantities

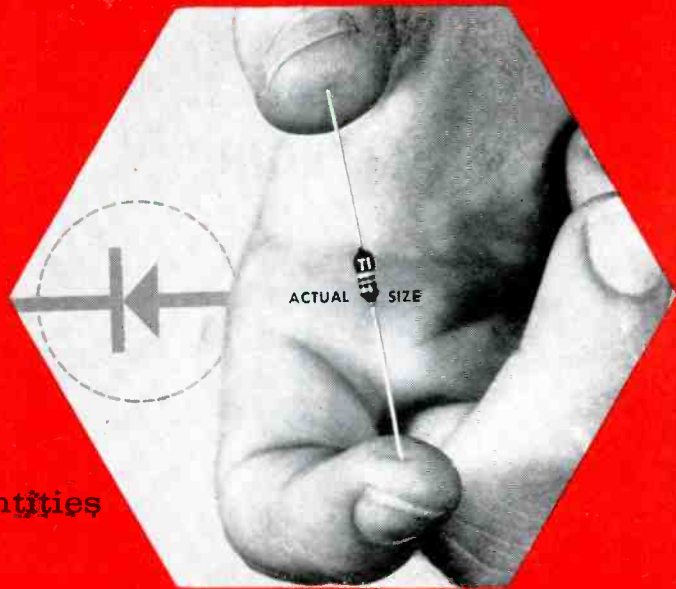

a new solution to your
inventory and spare parts problems:

You can now get big voltage operation (to 600 V) plus a new high in forward conductance (400 mA) along with a 2 million-to-1 forward-to-reverse current ratio . . . from new TI diffused silicon glass diode/rectifiers! This means you can eliminate scores of diodes and rectifiers from your inventories . . . and stock only five TI diode/rectifiers for virtually *all* your requirements. For your magnetic amplifiers, modulators, demodulators, networks or subminiature power supplies, this new TI diode/rectifier series — with its extremely wide 225 to 600 voltage range — will meet your exacting circuitry needs.

To see why, check these significant parameters:

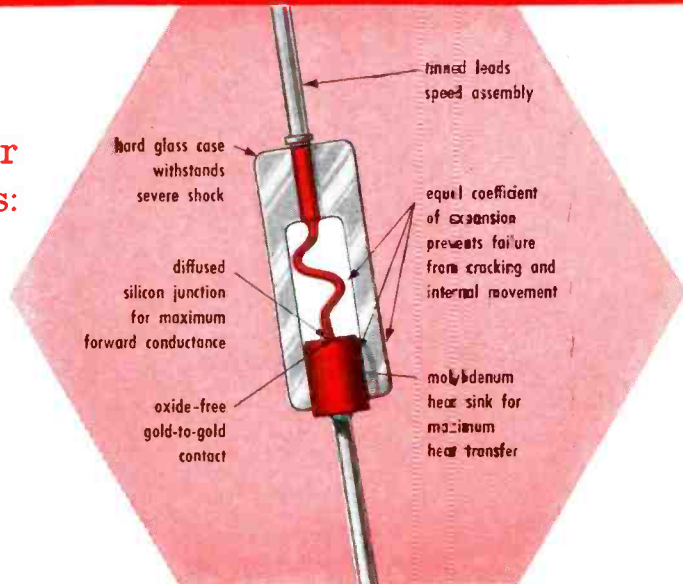

maximum ratings

	1N645	1N646	1N647	1N648	1N649	
Peak Inverse Voltage at -65 to +150°C	225	300	400	500	600	V
Average Rectified Forward Current at +25°C	400	400	400	400	400	mA
Average Rectified Forward Current at +150°C	150	150	150	150	150	mA
Recurrent Peak Forward Current at +25°C	1.25	1.25	1.25	1.25	1.25	amp
Surge Current, 1 Second DC at +25 to +150°C	3	3	3	3	3	Amp
Power Dissipation at +25°C	600	600	600	600	600	mW

specifications

	275	360	480	600	720	V
Minimum Breakdown Voltage at +100°C	275	360	480	600	720	V
Maximum Reverse Current at PIV at +25°C	0.2	0.2	0.2	0.2	0.2	μA
Maximum Reverse Current at PIV at +100°C	15	15	20	20	25	μA
Maximum Voltage Drop at I _O = 400 mA; at +25°C	1.0	1.0	1.0	1.0	1.0	V

Put TI diode/rectifiers to work for you now!
Write today for Bulletin No. DLS-770



TEXAS INSTRUMENTS
INCORPORATED
POST OFFICE BOX 312 · DALLAS · TEXAS

PROTECT ALL ELECTRONIC TUBES

WITH



Electronic Tube Protector

Designed To Protect All Electronic Tubes in TV or Hi-Fi Sets, Amplifiers, and Similar Electronic Equipment. Will Double or Triple Tube Life Including Picture Tubes.



List Price \$495—DEALER NET PRICE \$330

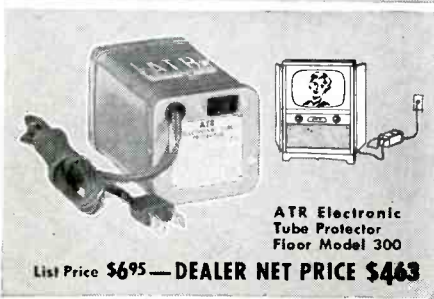

List Price \$695—DEALER NET PRICE \$463

ATR Electronic Tube Protectors will double or triple the life of all electronic tubes including picture tube in TV or Hi-Fi Sets, Amplifiers, Electronic Organs, and other similar electronic equipment. The ATR Electronic Tube Protector utilizes a thermal cushion-action principle which also protects all other components by eliminating initial damaging surge currents. The ATR Electronic Tube Protector can be used with any electronic equipment having input wattage of 100 to 300 watts.

SEE YOUR JOBBER OR WRITE FACTORY

✓ NEW MODELS ✓ NEW DESIGNS ✓ NEW LITERATURE
"A" Battery Eliminators, DC-AC Inverters, Auto Radio Vibrators



AMERICAN TELEVISION & RADIO CO.
Quality Products Since 1931
SAINT PAUL 1, MINNESOTA, U. S. A.

Circle 83 Readers Service Card

ELECTRONS AT WORK

(continued)

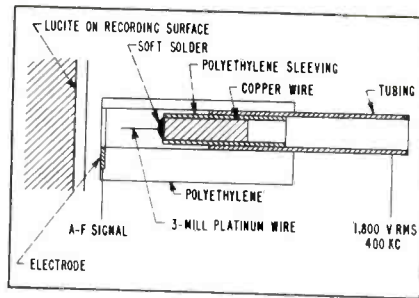

FIG. 2—Recorder uses high voltage carrier

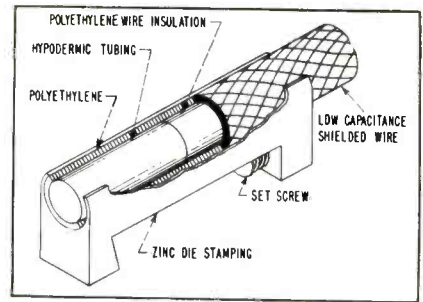

FIG. 3—Dielectric recorder playback head

medium can cause change of signal level. This is a relatively slow process. For playback of the signal a simple capacitive probe can be held near the surface of the drum. ▶ **Dielectric**—The dielectric material is selected for the decay time of a surface charge stored upon it. Methyl methacrylate, (Lucite) polystyrene, polyethylene and Teflon have decay time constants ranging from 80 hours for Lucite to over 3,000 hours for polyethylene. Because of its machinability and the availability of large thin wall extruded tubing, Lucite was used in the construction of the recorder.

The recorder as shown in Fig. 2 consists of a conductor placed near the dielectric and insulated from the

surface by a thin layer of air. A 400-kc signal applied to the platinum center wire breaks down the air insulation to permit recording. The playback head is shown in Figure 3. Since the characteristic impedance of the playback head is capacitive, it is relatively simple to use a number of pickup heads in parallel.

A comparison of dielectric and magnetic recording is given in Table I. The dielectric recorder offers an inherently high dynamic range. Upper recording voltage limit is determined by breakdown along the surface of the dielectric.

This information has been abstracted from an article "Dielectric Recorder" by V. C. Anderson, *Rev Sci Inst.*, July 1957.

Table I. Characteristics of Dielectric and Magnetic Drum Recording.

	Dielectric drum	Magnetic drum
Surface speed	20 in./sec	100 in./sec
Head-to-drum spacing	5 mils	0.5 mil
Amplitude sensitivity of head spacing	0.5 db/mil	5-10 db/mil
Upper frequency response	400 cps	10 kcps
Low-frequency cutoff	<1 cps	100 cps
Min recorded wavelength	50 mils	10 mils
Dynamic range	60 db	50 db

Back Window Cathode-Ray Tube

By M. B. DIEGERT
Airborne Computer Laboratories
International Business Machines Corp.
Owego, N. Y.

IN THE BACK-WINDOW CRT, electronic and pictorial data on a 35-mm film strip, is projected optically through a back window in the tube and superimposed onto the phosphor viewing screen for comparison with the electronic display. This back-window design eliminates the

ghost-reflection problem of using mirrors in front of the tube for superimposition.

▶ **Features**—The ten-in. tube incorporates magnetic deflection and electrostatic focusing. Cylindrical tube shape minimizes size of the back window. Windows are located as close as possible to the electronic axis of the tube to minimize optical

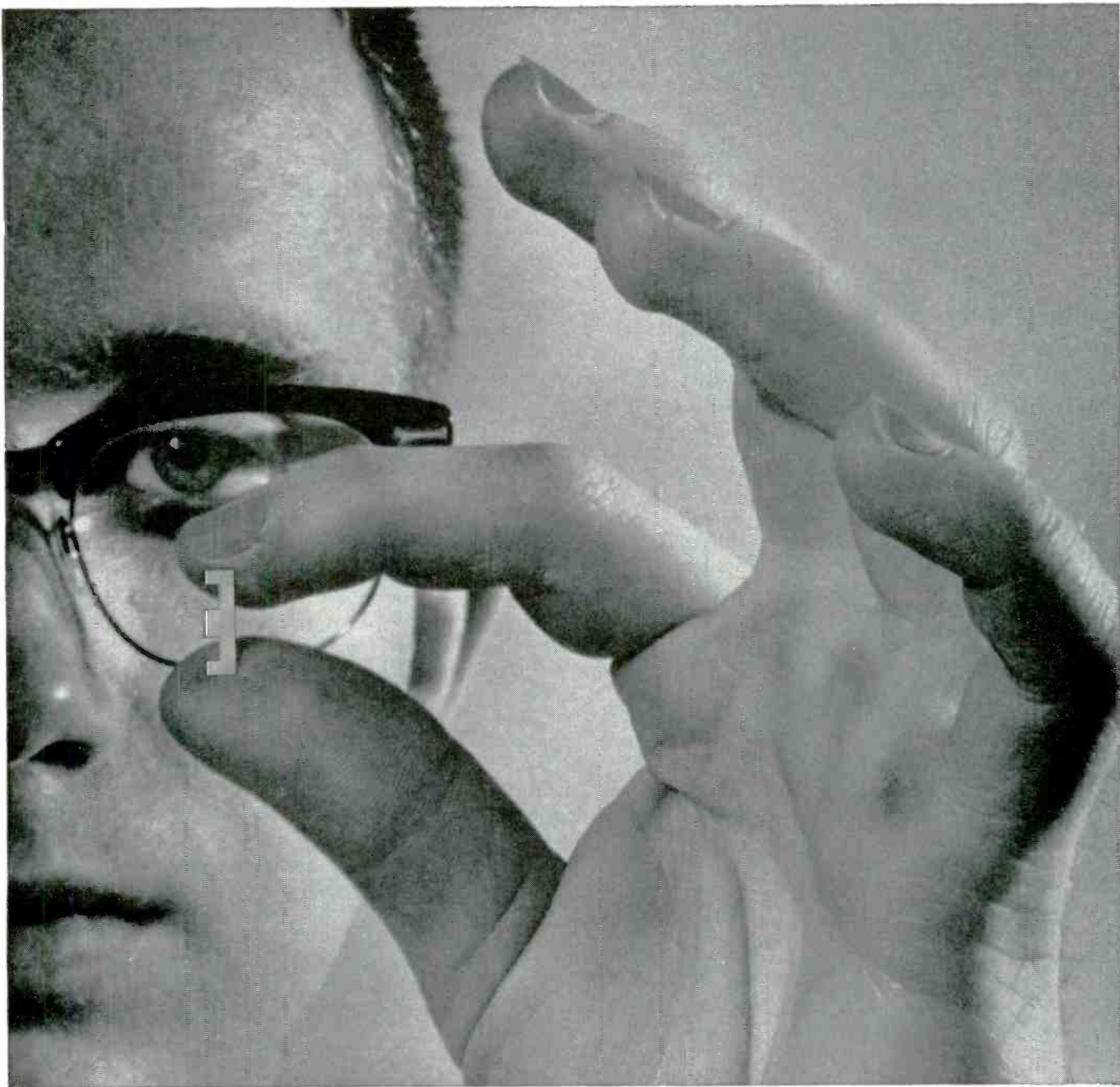

Here are laminations for miniaturization

If you are making transformers for transistorized or other miniaturized equipment, information about our ultra-small size "performance-guaranteed" laminations can be important news to you. These nickel-iron laminations are produced in standard gauges, and are available in Hy Mu 80, 48 Alloy and, if required, Orthonol.

Dry-hydrogen annealed by our exclusive process, these laminations provide all-important uniform quality. This annealing at a dewpoint of -60°C . brings our Performance-Guaranteed laminations to ultimate permeability from as little as 5% of that value in the unannealed state.

Like all laminations from Magnetics, Inc., the "miniatures" are packed in standard nine-inch boxes to facilitate handling in your plant, and are immediately available from stock. These features alone provide substantial savings.

Edges of these fine tolerance laminations are cut off squarely and cleanly to minimize air gap where mating parts are butted. Thus, high operating efficiency is insured.

There's no room here for the really detailed story, but for complete information on our "Performance-Guaranteed" magnetic laminations, send for our newest catalog—just published—ML-301. Write today. *Magnetics, Inc., Dept. E-41, Butler, Pennsylvania.*

MAGNETICS inc.

Looking
for **HIGH**
DIELECTRIC
STRENGTH ?

get **6.2** Kv/mil
with **NATURAL**
MICA!

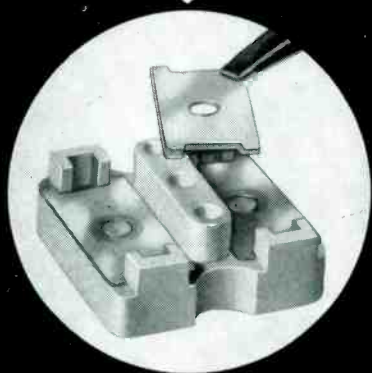

One-mil dielectric mica barrier used in microwave trimmer capacitors.

Natural mineral MICA provides high dielectric with excellent compressive and flexural properties: coil thin films around 1/8" mandrels—without damage. Add 1000°F. stability, low thermal conductivity, expansion.

And only FORD can shape and fabricate MICA into the precise form you need. Write for MICA BULLETIN and details.

your
PROBLEM ?

... Discuss it with FORD MICA engineers, backed by 40-year-plus leadership in mica insulation precision-stamping and fabrication.

Since
1917

FORD RADIO
& MICA CORP.

536-540 63rd Street
Brooklyn, N.Y. GEdney 9-8300

Circle 85 Readers Service Card

complexity. The main body of the tube consists of a conventional faceplate, a central cylinder and a backplate. The neck is attached to the tube by means of a flared protrusion on the backplate.

The bulb backplate is pressed from standard crt bulb glass in the conventional manner. However, during the pressing operation, raised portions or bosses are included at selected positions around the flared protrusion. These bosses, after grinding and polishing, become the flat, parallel-sided windows that permit the formation of high quality optical images on the screen.

► **Optics**—The optical system, shown in Fig. 1, departs from conventional projection optics to ensure full screen coverage. This is obtained by locating the short-focal-length, wide-angle projection lens close to the back window of the crt. Image forming lenses are oriented with their axes parallel to the tube axis to prevent keystone distortion. Due to the displaced position of the projection lens, a field lens is used to collect the image-forming rays to give uniform screen illumination.

► **Use**—The back-window cathode-ray tube can be used in radar-guidance systems, both military and commercial, where route maps, air-

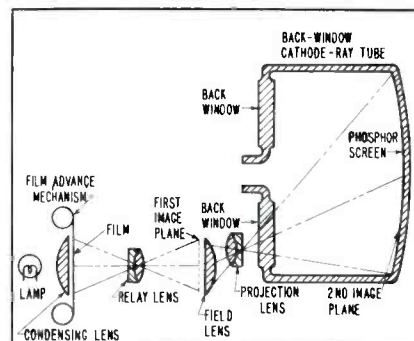

FIG. 1—Optical projection system for displaying pictorial data on phosphor screen of back-window cathode-ray tube. Additional back windows permit photographing combined pictorial and electronic display by means of an optical system similar to that used for projection of pictorial data onto the screen

port traffic patterns or other optical information superimposed on the electronic display will aid the operator in interpreting the radar image.

This type of crt can be used also to photograph an electronic display through the back window. With more than one window provided, a combined electronic and optical display can be recorded. Photography through the rear of the crt can be accomplished with an optical system similar to the one used for projection of pictorial data. Rear screen recording provides an advantage in brightness and resolution over front-screen photography.

Low-Voltage Gun Gives Good Color Image

POST ACCELERATION color tubes require a compact assemblage of small diameter low voltage guns. Despite size and voltage restrictions, these display devices must produce images that have a high degree of color purity, good depth of focus and small spot size. The tricolor gun assembly discussed here was specifically designed to fulfill this need.

► **Gun Assembly Characteristics**—The assembly consists of three guns arranged in a plane perpendicular to the phosphor stripes on the color tube screen. Although this configuration requires a smaller barrel diam-

eter than triangular positioning, the problem of beam convergence is greatly simplified. Various convergence schemes can be used; however, the three guns in this assembly were mechanically pre-converged.

Anode potentials required for the individual guns are between 5,000 and 7,000 volts as compared to the 20,000 to 30,000 volts required by other color tube display devices. The inside diameter of each gun is 0.358 in.; the center to center distance between neighboring guns at their exits is 0.427 in.

► **Functional Considerations**—The physical and electrical design limi-

CEC announces the new

ALECTRA line ...

portable test instruments

...with laboratory precision

**ALL-TRANSISTOR CIRCUITRY
ON PRINTED WIRING**

Now, for the first time, you can order precision instruments from a *complete, lightweight line* of miniaturized units of identical size. Salient features are battery operation, transistor circuitry, printed wiring. Rubber feet and collapsible leather handles guarantee easy, practical stacking. Also readily adaptable to standard rack mounting, these units assure instant stable operation with no warm-up time. *Contact your CEC field office, or write today for Bulletin CEC 7000-X1.*

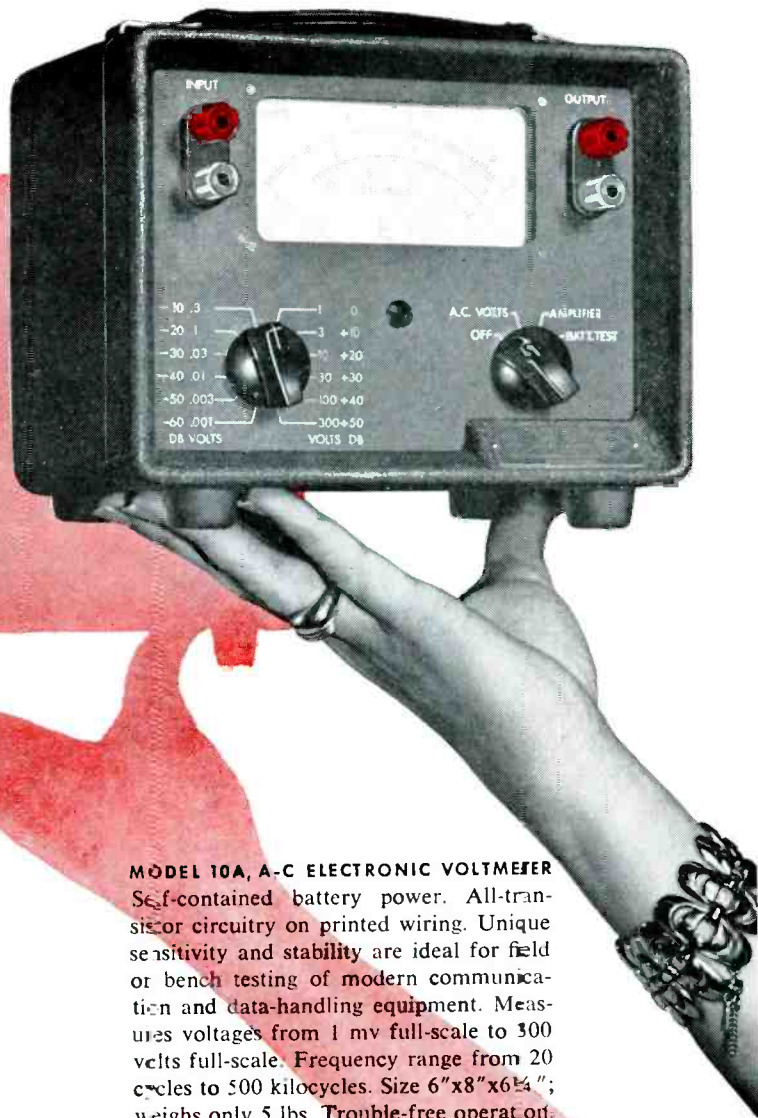

MODEL 10A, A-C ELECTRONIC VOLTMETER
Self-contained battery power. All-transistor circuitry on printed wiring. Unique sensitivity and stability are ideal for field or bench testing of modern communication and data-handling equipment. Measures voltages from 1 mv full-scale to 300 volts full-scale. Frequency range from 20 cycles to 500 kilocycles. Size 6"x8"x6 1/4"; weighs only 5 lbs. Trouble-free operation. Competitively priced.

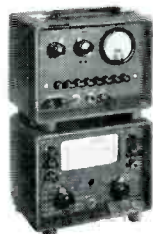

**MODEL 25A
TEST OSCILLATOR (TELECOMMUNICATIONS)**
8 preset frequencies (pushbutton)
Balanced output—600 ohms impedance

**MODEL 15A
MULTI-RANGE A-C VOLTMETER**
Balanced input—30 cps to 300 kc
1 mv to 300 v full-scale



MODEL 14A, TRUE-RMS A-C VOLTMETER
0.5 mv full-scale
Response: 10 cps to 500 kc



**MODEL 20A
TEST OSCILLATOR**
15 cps to 150 kc
0.5-ohm output impedance



MODEL 11A, DBM/DBA METER
For bridging 600-ohm circuits
Balanced input—50 cps to 25 kc



**MODEL 21A
TEST OSCILLATOR (PUSHBUTTON)**
8 preset frequencies
15 cps to 150 kc



**MODEL 40 SERIES
CARRIER FREQUENCY ATTENUATORS**
0.2 db accuracy, d-c to 600 kc
1-db steps to 82 db

Consolidated Electrodynamics

ALECTRA DIVISION



325 North Altadena Drive, Pasadena 15, California

OFFICES IN PRINCIPAL CITIES THROUGHOUT THE WORLD

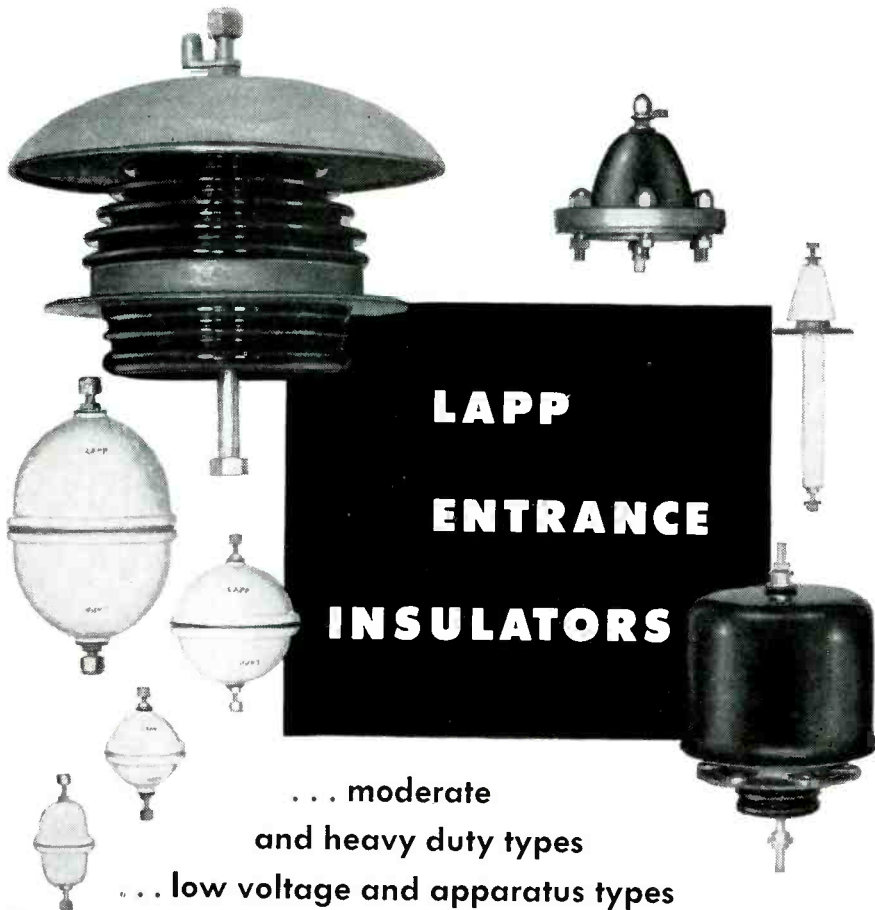

A design which uses air as major insulation, with leakage path lengthened by forming porcelain into a bowl, eliminates losses which occur in ordinary types of bushings at radio frequency.

Lapp moderate duty insulators, suitable for a variety of low or medium voltage applications, are the standard type bowls for carrying leads through shields, equipment cases, walls, etc., and practically any indoor use where duty is not too severe.

Outdoor units are designed with corrugated surfaces which provide extra leakage distance for use in contaminated atmosphere. Corrosion-resistant hardware.

A wide variety of types of these insulators is now available as catalog items . . . or where requirements necessitate, on special design—for which Lapp engineering and production facilities are excellently qualified. Write for complete descriptive data and specifications. Lapp Insulator Co., Inc., Radio Specialties Division, 136 Sumner Street, Le Roy, N. Y.



Lapp

tations presented two problems: small electrode diameters require the beam to utilize a large cross section of the lenses resulting in excessive aberration, and low anode voltages cause the spot size to become unacceptably large.

Excessive aberration is avoided by keeping the beam narrow as it enters the focusing lenses and by minimizing beam deviation from the axis. This was accomplished by using closely spaced focusing lenses which tend to return the beam to the axis when deviations occur.

Large spot size is circumvented by designing the first lens (the immersion lens) in such a manner that

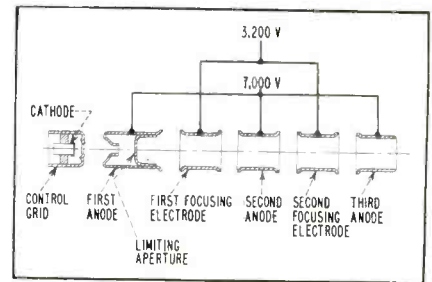

FIG. 1—Basic design of periodic focusing triode color-tube gun

its strength is maintained while the voltage ratio, and consequentially the focal length, of the focusing lenses are kept the same as in high voltage guns. This is accomplished by shifting the principle planes of the lens system toward the phosphorus screen by using two saddle field lenses on each gun.

► **Design Considerations**—Both triode and tetrode guns were built and tested. Although tetrodes exhibited smaller beam angle deflections, triodes were preferred since they can be more easily assembled—a feature which gives better overall performance. The basic design of the triode is shown in Fig. 1.

Cylindrical electrodes are used because the spacing between focusing electrodes and anodes can be made small enough to keep penetration by external fields at a negligible level. Each electrode is approximately one diameter long with the exception of the first anode which is two diameters long. These lengths developed from a compromise between the necessity for shifting the principle planes farther forward to assure acceptable spot size

High Voltage Silicon Rectifiers

VOLTAGE TO 1000 VOLTS · CURRENT TO 1 AMPERE

Features . . .

- Reliability at High Temperatures
- High Power Handling Ability
- Small Size
- Hermetically Sealed

Now Transitron offers 1000 and 800 volt silicon rectifiers in two standard packages. The proven stud mounted type can handle current up to 1000ma in temperatures to 125°C. For current ratings to 250ma use the new axial lead type — easy to mount, with no need for insulation. Either type may be used with confidence wherever high forward conductance and low leakage are important . . . for power supplies, magnetic amplifiers, and low frequency switching applications.

High voltage rectifiers are the latest to join Transitron's expanding family of reliable, efficient silicon rectifiers. Transitron offers a large variety of packages and a wide range of voltage and current ratings.

STUD MOUNTED . . . RATINGS AT 125°C CASE

Type	Maximum Inverse Operating Voltage (volts)	Maximum Average Forward Current (ma)	Maximum Average Inverse Current (full load) (ma)
TM104	1000	1000	.5
TM105	1000	400	.5
TM84	800	1000	.5
TM85	800	400	.5

AXIAL LEADS . . . RATINGS AT 100°C AMBIENT

Type	Maximum Inverse Operating Voltage (volts)	Maximum Average Forward Current (ma)	Maximum Average Inverse Current (full load) (ma)
1N561	1000	250	.3
1N560	800	250	.3

Send for Bulletin TE-1351

Transitron

electronic corporation • wakefield, massachusetts



Transistors



Diodes



Regulators



Rectifiers





a new measure

in Celco

precision

TOROIDAL COMPONENTS



Whether it's a complex 10 winding magnetic amplifier or a simple choke . . . at Celco each toroid is precision-made. New core materials are used in Toroidal magnetic amplifiers, reactors and transformers to achieve maximum performance.

At Celco, the proper matching of cores, winding, handling, impregnation, encapsulation and electrical history of the final assembly is carefully controlled to maintain the original design characteristics.

Our years of design, development, and production know-how are available for application to your specific **TOROIDAL** problems.



Celco

Constantine Engineering Laboratories Co.
MAHWAH, NEW JERSEY

* For immediate attention,
call **DAvis 7-1123**
— or write today.

and necessity for establishing short distances between focusing lenses to prevent excessive aberration.

Periodic electrostatic focusing is used because it provides the simplest construction consistent with high performance.

► **Gun Construction**—The area around the control grid aperture is coined. This configuration causes the crossover to form in a region where the equipotential planes between the control grid and first anode are parallel. Under these circumstances, minimum aberrations are introduced by the field in the vicinity of crossover and the beam can be kept narrow without using a prefocusing lens.

A limiting aperture is placed in the first anode to limit the beam diameter before it enters the first focusing lens. Since the limiting aperture is close to the crossover point, good alignment of the aperture and the beam can be achieved. Secondary electrons emitted at the edge of the aperture are retarded by the decelerating field produced by the first focusing electrode. To maintain a constant voltage ratio regardless of voltage fluctuations, the focusing potential should be obtained from the anode voltage supply by means of a voltage divider.

► **Gun Performance** — Measurements of spot size, beam diameter,

Balancing Automobile Engines

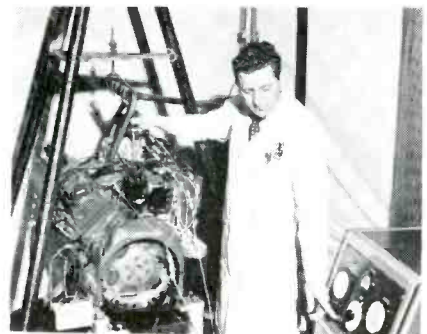

Balancing system developed by General Motors for detecting dynamic unbalance in production line testing of engines provides faster and simpler quality control. Magnetic pickups placed at each end of the engine are used to detect unbalance. Synchronizing pulses from the engine ignition are employed to determine location of unbalance. The unbalance is then eliminated by weighting the fanbelt pulley or flywheel

WESTON

250° SCALE PANEL METERS

*— sizes,
sensitivities,
accuracy,
damping,
to meet your
special needs!*



This comprehensive group of Weston d-c and rectifier type a-c panel meters provides not only increased scale readability, but higher accuracies and improved sensitivities and ballistic characteristics as well. Available in 2½"–3½"–4½" and 5½" sizes, in standard flanged and aircraft cases for a wide range of voltage and current indications, as well as for tachometry and temperature applications. All movements embody Weston spring-backed jewels, and are magnetically self-shielded permitting their use interchangeably on magnetic or non-magnetic panels. For the complete story, consult your nearest Weston representative, or write for literature. Weston Electrical Instrument Corporation, Newark 12, New Jersey.

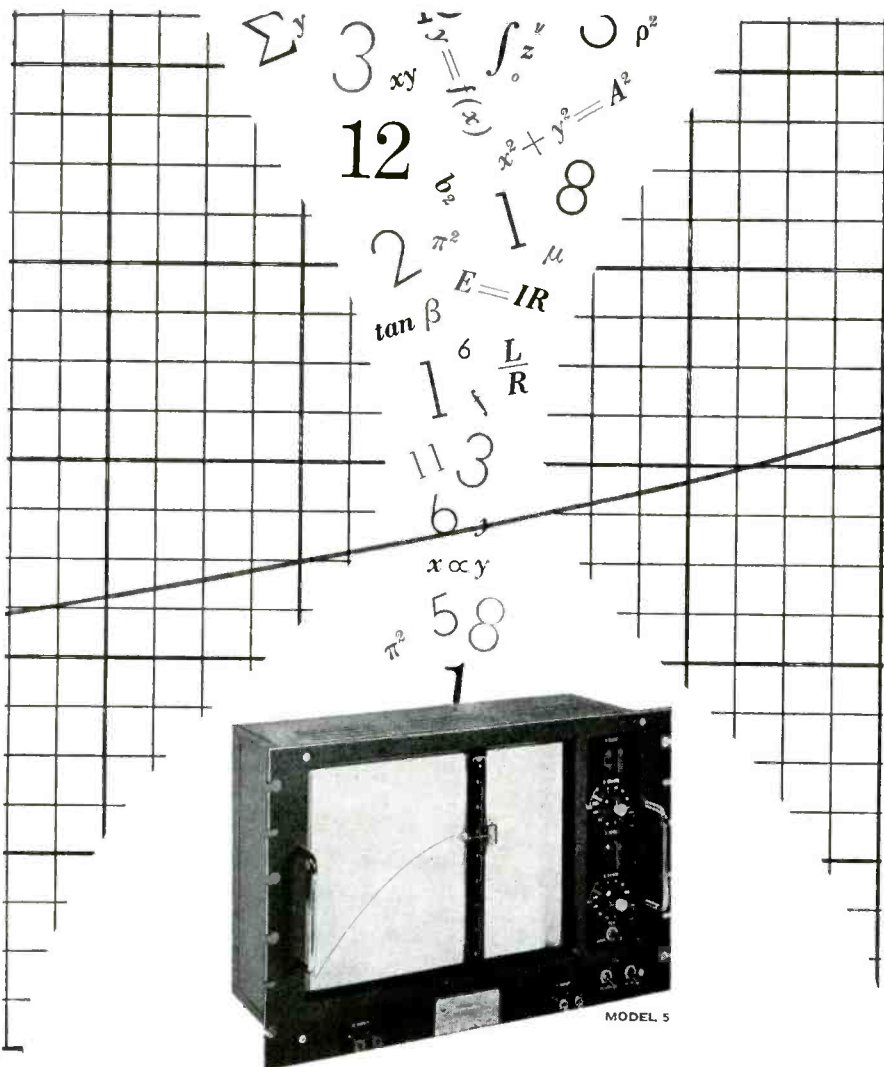

THE MOSELEY AUTOGRAF

X-Y RECORDER trade mark

Wherever mechanical, physical or electrical data is collected, the Moseley AUTOGRAF X-Y Recorder has earned an enviable reputation as a reliable and economical means for rapid, accurate automatic graphic recording. Precision manufactured and tested, the AUTOGRAF is available in a complete choice of models for bench use, rack mounting, large or small standard graph paper. A full line of accessories adapt the AUTOGRAF to almost any data translating problem, including card or tape reading, point plotting, curve following and curve drawing.



Model 20 DC Voltmeter A servo-actuated electronic voltmeter with large, easy to read linear scale. Ranges from 3 millivolts to 300 volts. Available with digital output.



Model 60 Logarithmic Converter 60 db dynamic range; AC or DC; 20-20,000 cps; with AUTOGRAF and appropriate signal generator automatically plots gain-frequency characteristics.

F. L. MOSELEY CO.

409 N. FAIR OAKS AVENUE, PASADENA, CALIFORNIA

Bulletins with complete information will be furnished on request.

and resolution were made with the gun assembly mounted in a monochrome tube. The exit end of the guns were placed $15\frac{1}{2}$ inches from the screen of the monochrome picture tube.

Spot size was determined by measuring the width, at half amplitude, of the distribution curve for spot brightness. At a screen current of 300 microamperes the spot size was 0.038 in. The size of the beam was measured from edge to edge using a wire mesh at the gun exit. This dimension was 0.130 in. at a screen current of 300 microamperes.

Assuming there is Gaussian current distribution, the beam diameter calculated at the half amplitude point of the current distribution curve, was estimated to be less than 0.075 in. at the gun exit and less than 0.060 in. in the plane of deflection. Therefore, the depth of focus is satisfactory.

Resolution, measured with an Indian head pattern chart, is over 500 X 500 lines at 200 microamperes screen current and about 480 X 480 lines at 300 microamperes screen current.

This article has been abstracted from a paper "Low Voltage Color Tube Gun Assembly with Periodic Focusing" by P. H. Gleichauf and H. Hsu of the Thermionics Section, General Electric Research Laboratories.

Pen Recorder Resolution Increase

By N. D. DIAMANTIDES
Goodyear Aircraft Corp.
Akron, Ohio

USEFULNESS of any multichannel direct-writing recorder can be extended by a relatively simple circuit in applications where recording resolution higher than ordinarily available in a single channel of the particular apparatus is necessary.

In analog computing it is occasionally necessary to observe a quantity represented by the output of an operational amplifier and measure correctly small variations of this quantity. This requires high recorder sensitivity in terms

for circuits requiring utmost voltage economy

GOLD BONDED

Radio Receptor Germanium Diodes

**10MA forward current
with a maximum loss
of only .37 volts!**

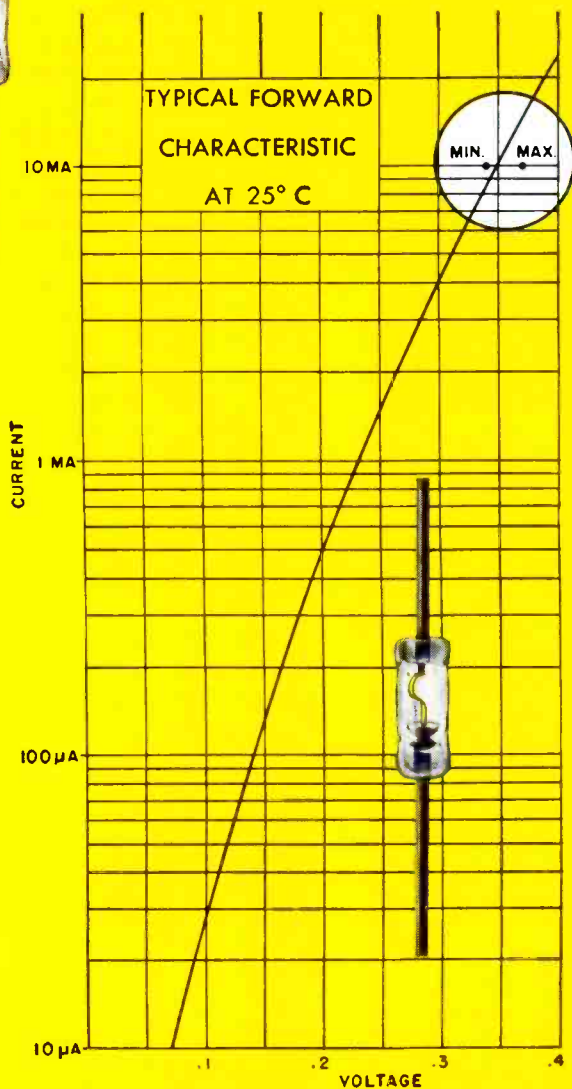

DR 385

DR 434

DR 435

This extremely low controlled forward voltage drop combined with fast transient response makes these diodes ideal for transistorized circuits, computers and other applications where conservation of power is of prime importance.

Characteristics at 25° C

	DR 385	DR 434	DR 435
Forward voltage drop @ 10MA			
Minimum	0.34V	0.34V	0.34V
Maximum	0.37V	0.37V	0.37V
Maximum reverse current at -10V	10UA	10UA	10UA
Peak inverse voltage	60V	40V	30V

Maximum ratings at 25° C

Maximum inverse operating voltage	50V	30V	20V
Continuous DC forward current	100MA	100MA	100MA
Surge current for 1 second	500MA	500MA	500MA
Average power dissipation	80MW	80MW	80MW
Derating above 25° C	10MW/10°C	10MW/10°C	10MW/10°C

Available now in production quantities for immediate delivery

For further information on these, or any other RRco. diode type, write today to Section

Semiconductor Division

RADIO RECEPTOR COMPANY, INC.

Subsidiary of General Instrument Corporation

240 Wythe Avenue, Brooklyn 11, N. Y. • Evergreen 8-6000

Radio Receptor Products for Industry and Government: Selenium Rectifiers • Germanium Diodes
Thermatron Dielectric Heating Generators & Presses • Communications, Radar & Navigation Equipment

RADIO & ELECTRONIC



PRODUCTS SINCE 1922

We Like to Help Control Quality



... it's Our Business!

Quality control at Lewis Spring is the most important factor in our business—it is present through every department in our plant from receipt of raw materials to final shipping. It is reflected in our engineering and design and equipment maintenance. It is a basic reason why Lewis Spring has so many good customers—they apply quality control in making their products, too. As an example, Lewis Spring was recently presented an award by Argus Cameras Division of Sylvania Electric Products Inc., Ann Arbor, Mich., for "Excellent Cooperation in Controlling Quality." We highly appreciate the compliment.

Lewis Spring would like to help *your* plant control quality . . . and we wouldn't have to get an award for it, because It's Our Business.

LEWIS SPRING & MANUFACTURING COMPANY
2656 W. North Avenue, Chicago 47, Illinois



The finest light springs and wireforms of every type and material

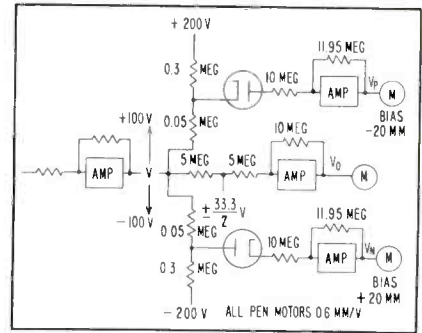

FIG. 1—Series-limited and two threshold-biased amplifiers

of millimeters per volt and sufficient channel width measured in mm on the recording paper. Increasing recorder sensitivity to a satisfactory level is not usually a problem provided care is exercised to avoid stray pickups.

Trying to accommodate a relatively widely varying quantity within the ± 20 mm of the paper channel (as in certain standard six-channel recorders) renders useless any advantage that the increased sensitivity affords. The following arrangement aims at the alleviation of the difficulty. Suppose that voltage V to be recorded varies in the range ± 100 v and that the paper channel width is $A = \pm 20$ mm while the maximum sensitivity available is $s = 0.2$ mm per volt.

This satisfies the necessary condition $A = V_n$. It is also possible to split the range of V in $n = 3$ equal parts.

$$\begin{aligned} -100 \text{ v} &\geq V_n \geq -33.3 \text{ v} \\ -33.3 \text{ v} &\geq V_o \geq +33.3 \text{ v} \\ +33.3 \text{ v} &\leq V_p \leq +100 \text{ v} \end{aligned}$$

This can be done easily using one series-limited and two threshold-biased amplifiers as shown in Fig. 1.

Channel sensitivity can be increased by a factor n since now the range V volts can be accommodated in a paper width $A_n = An$. The only drawback is slicing the recording into three separate graphs. Figure 2 represents an actual recording of a random wave blown up threefold.

► Accuracy—In the meter-movement type assumed here there exists a pen-motor-accuracy figure ϵ (say ± 2 percent of full travel) which is generally different at dif-

This is the
.....
30 to 115 ampere*
silicon power diode

that operates cooler-
has a greater surge current capacity-
and mechanical stability
needed to last in
industrial use!

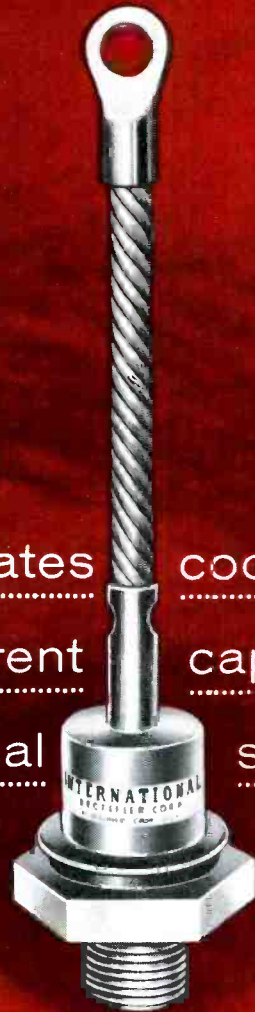

NOW IN FULL PRODUCTION AT

International



Rectifier Corp.

*Half wave circuit

If you are a discerning engineer with an eye for reliability, you have probably guessed that these are the silicon power diodes that stand up...where others fail! Cooler operation stems from the conservative rating and a shorter thermal path in the package, which provides a higher rate of heat transfer...and it comes about without extraneous hardware!

Conservative rating also means a lower current density in the crystal, and thus a greater surge current or pulse overload capacity, proved in tests to be considerably greater than that of other available types. Add all-welded, hermetically sealed construction for mechanical stability, and you have the ingredients for your most important design consideration...*reliability!*

For complete technical data, write for Bulletin SR-143D.

EXECUTIVE OFFICES: EL SEGUNDO, CALIFORNIA • PHONE OREGON 8-6281 • CABLE RECTUSA • NEW YORK AREA OFFICE: 132 EAST 70TH ST., PHONE TRAFALGAR 9-3330
CHICAGO AREA OFFICE: 205 W. WACKER DR., PHONE FRANKLIN 2-3888 • NEW ENGLAND AREA OFFICE: 17 DUNSTER ST., CAMBRIDGE, MASS., PHONE UNIVERSITY 4-6520
WORLD'S LARGEST SUPPLIER OF INDUSTRIAL METALLIC RECTIFIERS • SELENIUM • GERMANIUM • SILICON

Circle 94 Readers Service Card

the

A. W. HAYDON COMPANY'S ELAPSED TIME INDICATORS

measure a  of time... for

INDUSTRIAL, AIRCRAFT and MILITARY applications

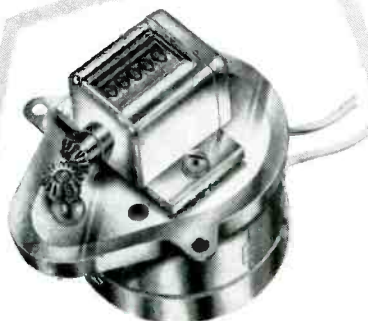

**7500 SERIES DC
ELAPSED TIME
INDICATOR**

Send for Bulletins: AWH ET600
Basic Elapsed Time Indicators.
7500, 12500, 24200 Series.

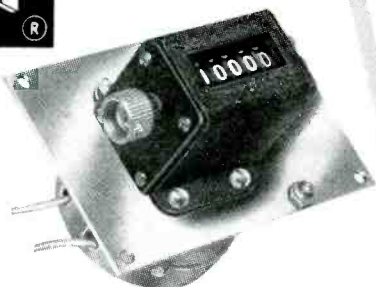

**7500 SERIES RESET TYPE
ELAPSED TIME INDICATOR**

Send for Bulletins: AWH ET601
Reset Type Elapsed Time Indicators
7500, 12500, 24200 Series.

Now the Company offers a complete line of timing motors and devices to record the operating time of any electrical or electronic equipment. Compact, minimum weight, each unit has five digits. They can be used to provide daily running time plus a total running record, eliminating estimating or manual totalizing. They increase efficiency and reduce costs, since they provide the quickest way to know when to lubricate, overhaul or replace equipment. They give on-the-spot pictures of idle and waiting periods for machinery. Used with electronic equipment, they tell when to replace tubes, preventing costly failures during essential operating periods.

In both AC and DC, continuous or manual reset for 50 or 60 up to 400 cycle line frequency. Will measure hours or on down to 10ths of seconds. All models can be supplied with Radio Interference Filtering to meet MIL-1-6181B.

Preferred Where Performance
is Paramount.



Shown at the left is the new A. W. Haydon Co. catalog describing the complete line of timing motors and devices; if you haven't received your copy write for it on your company letterhead.

The
A.W. HAYDON Company

235 NORTH ELM STREET, WATERBURY 20, CONNECTICUT

Design and Manufacture of Electro-Mechanical Timing Devices

ferent portions of the range. This pen-motor accuracy effect is reduced to ϵ/n .

Reading-accuracy, which is at the most ± 0.25 mm and which therefore represents ± 0.25 V/A volt is also improved to ± 0.25 V/An volt. Influence of the limitors remains to be examined.

For the threshold condition point A is at zero voltage, which means that $e_i/R_1 = +B/R_2$ and since $e_s = V/n$ it follows that $R_2/R_1 = nB/V$.

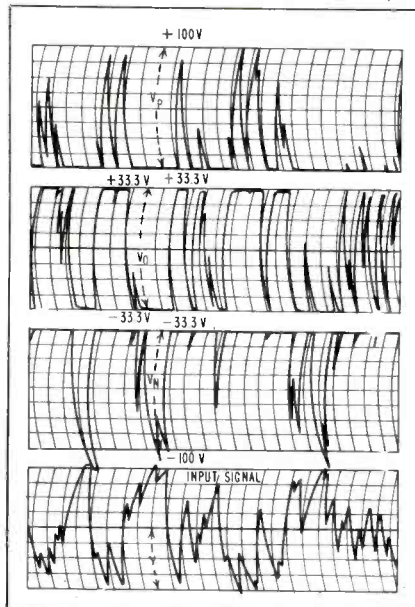

FIG. 2—Recording of random wave is split into various range values

Thus $R_1 = 0.05$ meg, $R_2 = 0.3$ meg.

Beyond the threshold condition the effective zero on the resistor MN (Fig. 3) moves to a distance β so that the loading effect of the resistor $R + r$ has to be taken into account. For a 6AL5 diode the effective plate resistance is 300 ohms $< r < 700$ ohms, which becomes negligible if R is chosen large, for instance $R = 10$ meg. Then

$$\frac{e_i}{R_1 + \frac{\beta R_2 R}{\beta R_2 + R}} = \frac{B}{R_2 (1 - \beta)}$$

Substitution of the parameter values mentioned previously and assuming $B = 200$ volts will result in $\beta = 0.222$ and $e_s = 56.98$. Since the output e_o has to be 66.66 volts the feedback resistor becomes

$$R_f = R \frac{e_o}{e_s} = 10 \frac{66.66}{56.98} = 11.7 \text{ meg}$$

The above resistance values re-

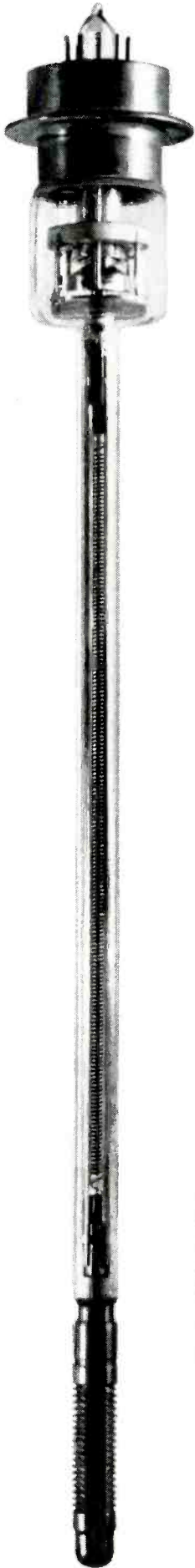

A GREAT AMPLIFIER TUBE IS PERFECTED FOR TELEPHONY

A new transcontinental microwave system capable of carrying four times as much information as any previous microwave system is under development at Bell Laboratories. A master key to this development is a new traveling-wave tube of large frequency bandwidth.

The traveling-wave amplifying principle was discovered in England by Dr. Rudolf Kompfner, who is now at Bell Laboratories; the fundamental theory was largely developed by Labs scientist Dr. John Pierce. Subsequently the tube has been utilized in various ways both here and abroad. At the Laboratories it has been perfected to meet the exacting performance standards of long distance telephony. And now for the first time a traveling-wave tube will go into large-scale production for use in our nation's telephone systems.

The new amplifier's tremendous bandwidth greatly simplifies the practical problem of operating and maintaining microwave communications. For example, in the proposed transcontinental system, as many as 16 different one-way radio channels will be used to transmit a capacity load of more than 11,000 conversations or 12 television programs and 2500 conversations. Formerly it would have been necessary to tune several amplifier tubes to match each channel. In contrast, a single traveling-wave tube can supply all the amplification needed for a channel. Tubes can be interchanged with only very minor adjustments.

The new amplifier is another example of how Bell Laboratories research creates new devices and new systems for telephony.

Left: A traveling-wave tube. *Right:* Tube being placed in position between the permanent magnets which focus the electron beam. The tube supplies uniform and distortionless amplification of FM signals over a 500 Mc band. It will be used to deliver an output of five watts.

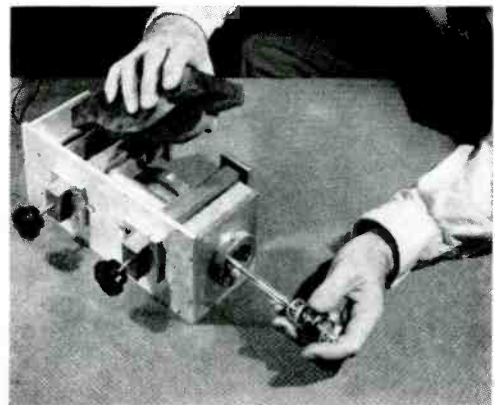

BELL TELEPHONE LABORATORIES

WORLD CENTER OF COMMUNICATIONS RESEARCH AND DEVELOPMENT



It's just part of the Victoreen story . . .

HIGH STABILITY RESISTORS

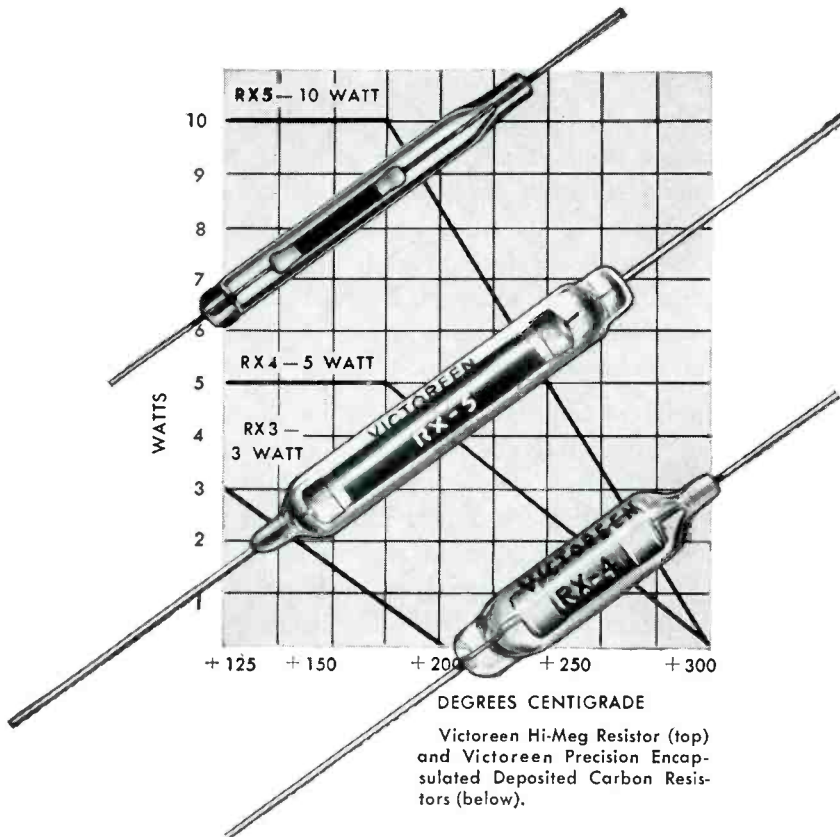

High stability, exceptional accuracy and performance that easily exceeds the normal electrical specifications of MIL 10509C—even in high ambients to 300°C where more than normal life expectancy is required. That's the story, in brief, of Victoreen deposited carbon resistors.

Hi-Meg resistors have a carbon-coated glass rod element, the ends of which are banded with silver for best electrical contact.

Hi-Meg resistors are vacuum-sealed in a glass envelope treated with special silicone varnish to keep envelope moisture-free.

For the ultimate in accuracy, stability and long-time performance, specify *Victoreen precision resistors*.

AA-5423

For the full story on Victoreen deposited carbon or Hi-Meg resistors, write for your free copy of Form 3025A.



The Victoreen Instrument Company
Components Division
5806 Hough Avenue, Cleveland 3, Ohio

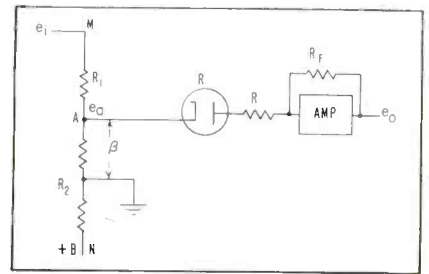

FIG. 3—Threshold circuit

sult in an error of -4 percent at the low end of range V_n , where $e_i = 33.33$ volts. Increase of the feedback resistance to $R_f = 11.95$ meg results in a +2.1-percent error at the high end ($e_i = -100 n$) and -2.1 percent at the low end ($e_i = -33.33 n$) of range V_n .

► **Limiter Circuit**—The inaccuracy introduced by the limiter circuit is of less importance than that of the threshold. Once the limit value is reached the part of the recording beyond it is of no significance. At the limiting condition and for the shunt input-limiter employed, the nodal equations at the amplifier input (Fig. 4) and at both sides of the diode are

$$\frac{e_B - e_A}{R_1} + \frac{e_B - e_o}{R} = 0$$

$$\frac{e_A - e_i}{R_1} + \frac{e_A - e_B}{R_1} + \frac{e_A - e_C}{r} = 0$$

$$\frac{e_C - B}{(1-\beta)R_o} + \frac{e_C - 0}{\beta R_o} + \frac{e_C - e_A}{r} = 0$$

Simplifying this system and taking into account that $e_B \cong 0$ it is found

$$e_o = \frac{R e_i}{1 + \frac{2\beta(1-\beta)R_o}{R_1}} - \frac{\beta R B}{R_1}$$

$$\frac{B}{1 + \frac{2\beta(1-\beta)R_o}{R_1}}$$

If $R_o \ll R_1$ this equation gives

$$e_o = -\frac{R}{R_1} B$$

Since the maximum value of the factor $2\beta(1-\beta) = 1/2$ occurs at

$\beta = \frac{1}{2}$ the maximum error introduced by the first term in the expression for e_o will be

$$\Delta e_o = -\frac{R}{2R_1} \frac{\theta}{1 + \frac{2R_1}{R_o}} e_i$$

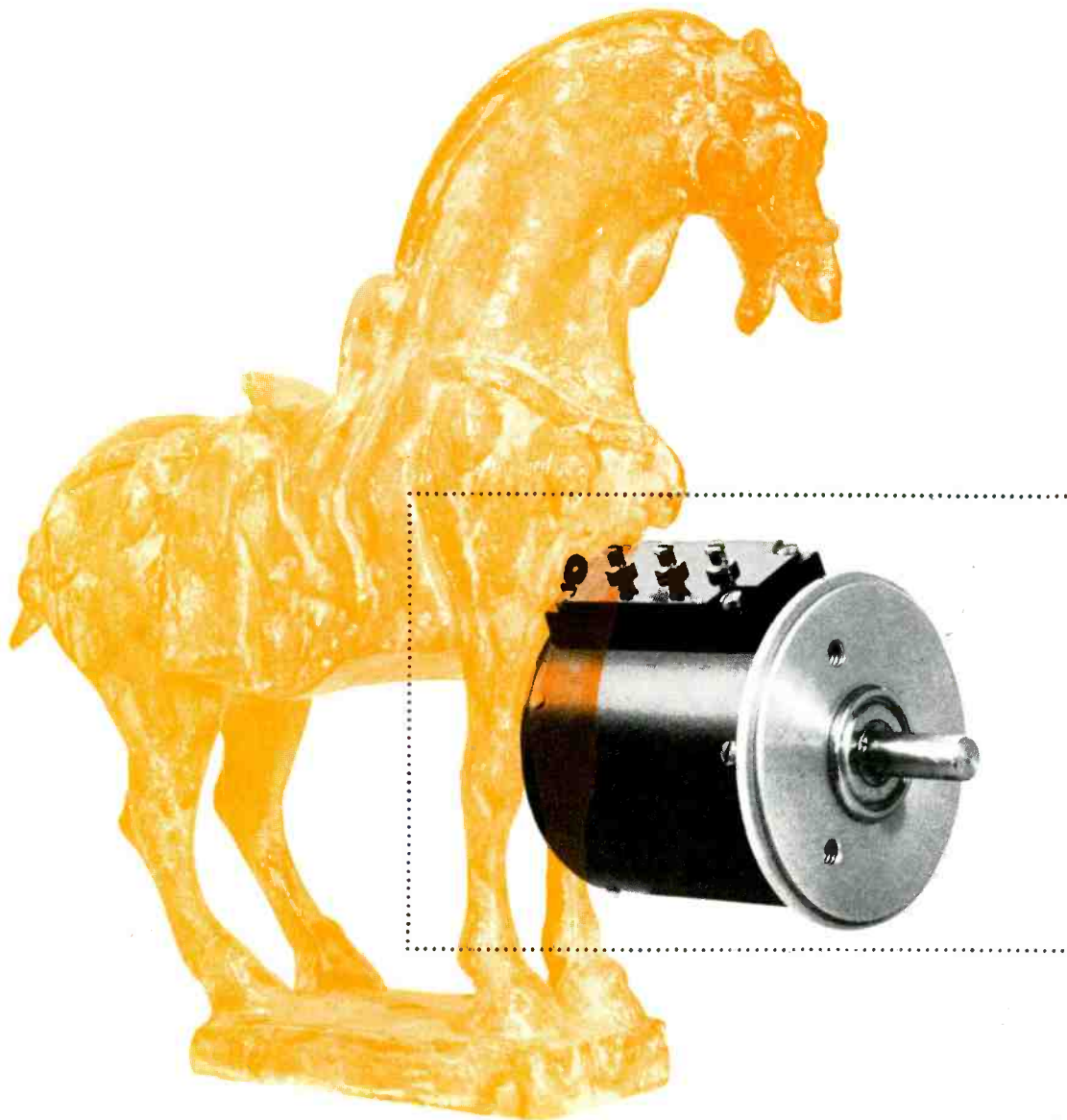

Ceramic thoroughbred . . . with 0.01% linearity

POTENTIOMETER SPECIFICATIONS

*.05% to .01% independent linearity
1K to 100K standard resistances
.02% to .005% resolution
depending upon resistance value
3600° +1°/-0° electrical angle
5 watts power dissipation at 40° C
Taps are welded and can be supplied
in any location on special request
90° nominal overtravel
1.0 oz. in. starting torque
0.75 oz. in. running torque
500 oz. in. static stop torque
Servo mounting standard*

In our new potentiometer we took our cue from a fundamental fact: the simpler the better. We eliminated a number of individually machined and mounted parts and returned to a material that has handsomely served some of the world's oldest civilizations. Namely, ceramic.

The MD 20 potentiometer can function consistently at 0.01% linearity under severe conditions. The ceramic core is dimensionally stable. Its coefficient of thermal expansion closely matches the resistance element mandrel for high temperature operation. A simple, one-piece aluminum hub provides an accuracy reference that is extremely rugged.

Applications of the MD 20 are more varied than those of other potentiometers available today. We invite you to see it and discover how it may provide the breakthrough you've been looking for.

LITTON INDUSTRIES COMPONENTS DIVISION
Department B, 215 South Fulton Avenue, Mount Vernon, New York

"Just Doing a Little Exploring!"

If you're the man
whose product needs
this Tung-Sol Relay—
then it's you I'm
exploring for



Tung-Sol produces a line of thermal relays in the general operating range characterized by the Type 609. Snap action contacts and extremely sensitive actuating heater elements provide uniform cycling. Operating principle permits manufacture of time delay relays and relays which function on small differential of voltage and current. Compact and lightweight, Tung-Sol relays are ideal for instruments and electrical equipment application.

NOMINAL DESIGN CONSIDERATIONS

Contact capacity.....1 amp 30 volt resistive
Contact arrangement.....SPST (NC) or SPDT
Operating power.....As low as 1/2 watt
Time delays.....Up to 5 seconds
Operate on current differential as small as .05 amps
Operate on voltage differential as small as .3 volts

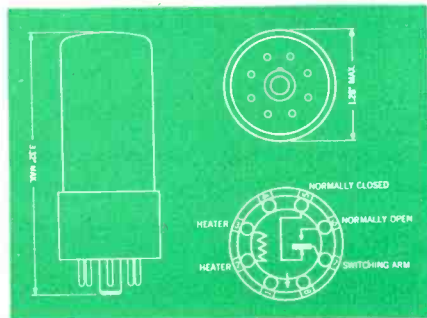

NOMINAL CHARACTERISTICS OF 609

Operating voltage.....6.4 volts
Operating time.....1. plus or minus .5 seconds
Release time.....1. plus or minus .5 seconds
Contact capacity.....1 amp at 30 volts
Contact arrangement.....SPDT

For additional data write:

Electroswitch Division, Tung-Sol Electric Inc., Newark 4, N. J.

Sales Offices: Atlanta, Ga.; Columbus, Ohio; Culver City, Calif.; Dallas, Tex.; Denver, Colo.; Detroit, Mich.; Irvington, N. J.; Melrose Park, Ill.; Newark, N. J.; Philadelphia, Pa.; Seattle, Wash. Canada: Montreal, P. Q.

TUNG-SOL THERMAL RELAYS

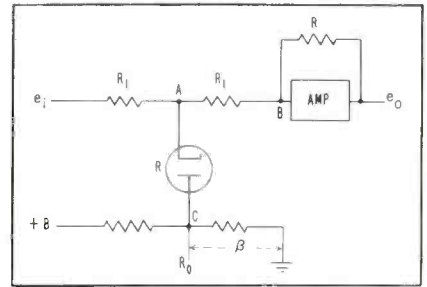

FIG. 4—Nodal equations are based on this circuit

which for $e_i = 100$ volts and $R_o/R_i = 0.01$, $R/R_i = 2$, $\Delta e_o = 0.5$ volts or 0.5 percent.

Ordinary analog computer applications do not tax the frequency response capabilities of recorders heavily. For recordings with higher frequency content the extended resolution will be bought at the expense of definite attenuation. Since the pen tip is forced into displacement n times larger than under ordinary recorder operation, reactive forces owing to friction increase by a constant proportional to n while forces resulting from acceleration increase by a factor proportional to n^2 . This is equivalent to saying that the dynamic range of the recorder is reduced accordingly.

Avoiding Blown Fuses With Capacitive Loads

By SERGIO BERNSTEIN
General Precision Laboratory Inc.
Pleasantville, N. Y.

FUSE BLOW-OUTS that occur in regulated power supplies when switching large capacitive loads are annoying to laboratory engineers but intolerable to the broadcast engineer.

The most economical way of operating a large installation of electronic equipment, as in a broadcast studio, is to have the equipment necessary left on stand-by operation. Only filament power is applied continuously and the equipment is instantly operative when B+ power is switched on.

In such large installations it is also economical to have a single large rectifier supplying unregu-

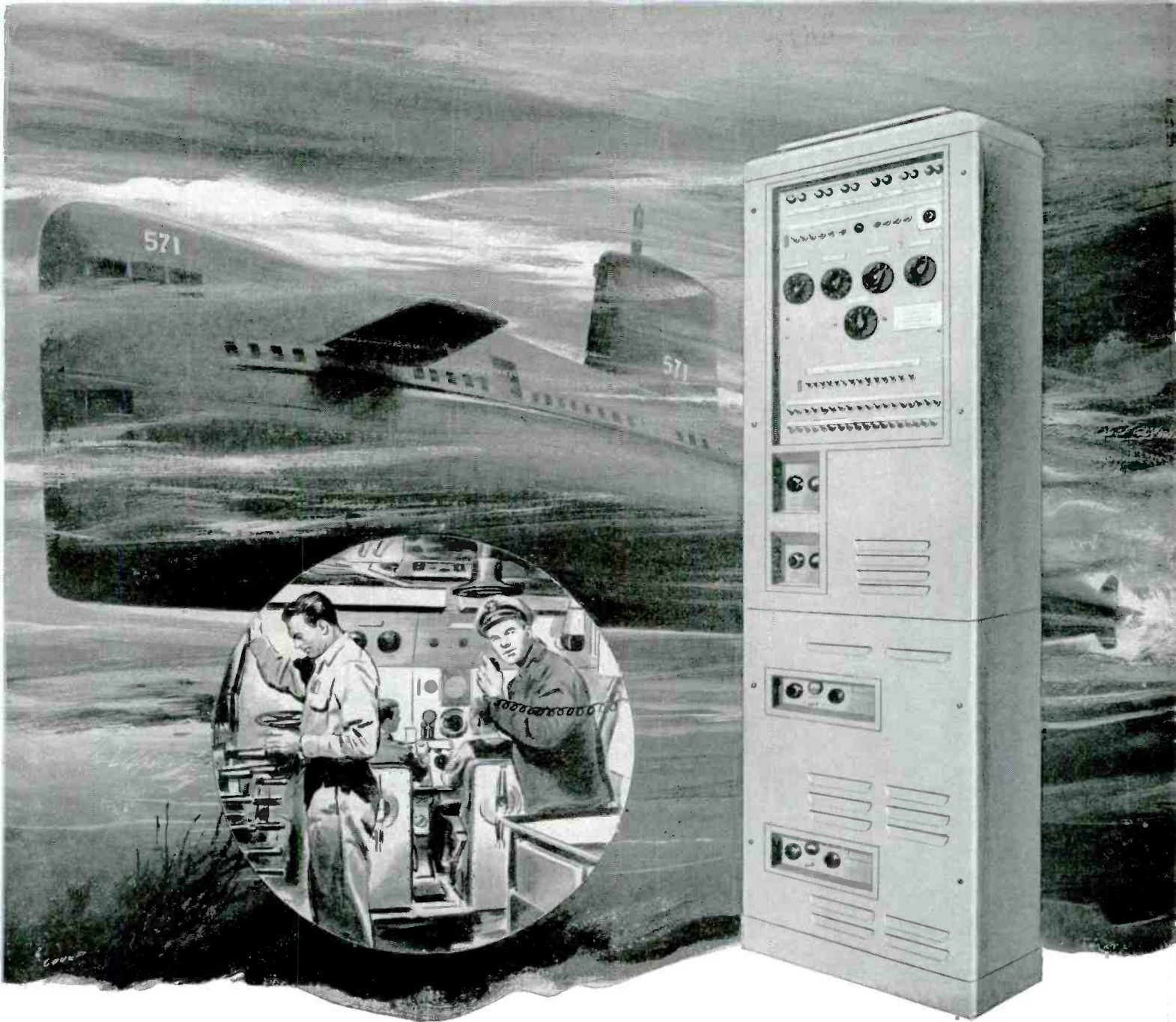

To voice the world's newest submersibles

The shipboard and battle-announcing needs of a submarine pose problems that just "standard" equipment can't meet.

Exceptional ruggedness is required, both to withstand shock and to resist heat, humidity, and salt moisture.

Power must be adequate, yet compressed into the smallest possible space.

Dependability is relative to such factors as cruise distances never before attempted by underwater craft.

An example of products meeting such prob-

lems is found in the announcing equipment aboard the atomic-powered *Nautilus* and *Sea-wolf*, built by our associate division, Electric Boat, and "voiced" by Stromberg-Carlson. Here standard components were re-designed to the special conditions involved. On the *Nautilus*, to date, our equipment has logged more than 60,000 nautical miles without difficulty of any sort.

Similar equipments also serve the land and air arms of our country's military forces and give evidence of equal dependability under the special conditions for which they were designed.



STROMBERG-CARLSON

A DIVISION OF GENERAL DYNAMICS CORPORATION

General Offices and Factorias at Rochester, N. Y.—West Coast plants at San Diego and Los Angeles, Calif.



Circle 99 Readers Service Card

Shallcross BRIDGES

Types
6100
and
6101Type
6320Type
638-R617
SeriesType
6350

ACCURATE dc RESISTANCE MEASUREMENTS

... 1 micro-ohm to 10⁶ megohms

Among the many bridges manufactured by Shallcross, these six have become virtually "standards" for general-purpose resistance measurements. Each is easy to operate and ruggedly constructed to maintain accuracy and stability in every kind of field and laboratory service. Switch decks are inside the case for minimum maintenance.

Of special interest are the 617 Series Limit Bridges. These provide direct "GO-NO GO" production line resistor testing for any percent tolerance spread from $\pm 0.1\%$ to $\pm 20\%$.

NEW BULLETIN L-19B contains full specifications for each instrument. For your copy write to: SHALLCROSS MANUFACTURING COMPANY, 522 Pusey Avenue, Collingdale, Pa.

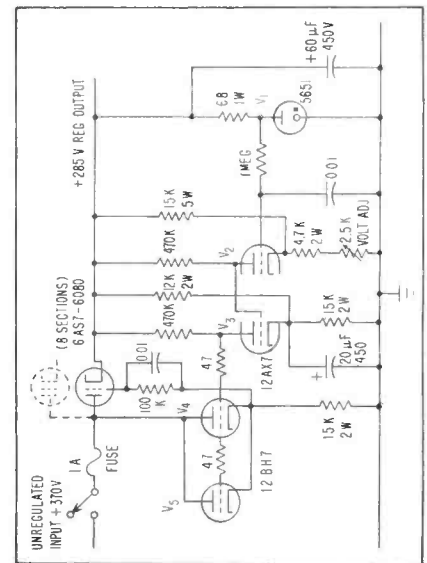

FIG 1—Circuit of typical electronic regulator

lated d-c power. Electronic equipment is then used to supply regulated B+ power to individual equipments.

A typical regulator such as that in Fig. 1 is designed for 1-ampere capacity. The input voltage is 370 volts and the output voltage is 285 volts. Each regulator includes a high-gain d-c amplifier and four type 6AS7 (6080) series regulator tubes.

Depending on the B+ power requirements of the equipment, one or more such regulators is used to furnish plate power.

With either input or output switching, the regulators are forced to deliver not only the normal steady-state B+ current, but also a very high momentary peak current required to charge all the bypass capacitors in the equipment. In large equipments, it is not inconceivable that the total capacitance appearing on the B+ bus is in the order of 200 μ f.

Thus, if the steady-state current for a particular equipment is 1 ampere at 285 volts, the transient load as seen by the regulator will be a resistor of 285 ohms shunted by a capacitor of 200 μ f.

Immediately after switching, because voltage is prevented from rising abruptly, the cathodes and grids of the series regulator tubes are at ground potential and the plates are at 370 volts.

Extrapolation of tube characteristics for a 6AS7, shows a surge

Model Number	Measurement Accuracy	Maximum Setting	Minimum Setting	Circuit	Special Features
6100	$\pm 0.1\%$ $\pm 0.01\Omega$ (1Ω to 1.011 Meg Ω)	1.011 Meg Ω	0.001 Ω	Fault Location—Wheatstone	Fault Location by Murray, Varley, Hilborn & Fisher Loop Tests.
6101	$\pm 0.1\%$ $\pm 0.01\Omega$ (1Ω to 11.11 Meg Ω)	11.11 Meg Ω	0.001 Ω	Wheatstone	Four dial rheostat usable as decade box.
6320	$\pm 0.02\%$ $\pm 0.01\Omega$ (1Ω to 11.11 Meg Ω)	111.11 Meg Ω	0.00001 Ω	Wheatstone	Most accurate five dial Shallcross bridge for direct resistance measurement.
	$\pm 0.05\%$ to $\pm 20\%$ on separate "+" and "-" percent selectors. (1Ω to 10 Meg Ω)	11.1111 Meg Ω	0.0001 Ω	Percent Limit	Rapid "GO-NO GO" percent limit testing. Built-in adjustable comparison standard.
638-R	$\pm 0.75\%$ or better (0.001Ω to 1Ω)	11.11 Ω	0.000001 Ω	Kelvin	Overlapping Kelvin and Wheatstone ranges selected with single ratio dial.
	$\pm 0.2\%$ $\pm 0.01\Omega$ (1Ω to 11.11 Meg Ω)	11.11 Meg Ω	.001 Ω	Wheatstone	
6350	$\pm 1\%$, (10 Ω to 10 Meg Ω) $\pm 2\%$, (10 Meg Ω to 10,000 Meg Ω) $\pm 5\%$, (above 10,000 Meg Ω)	1.111 x 10 ⁶ Meg Ω	0.01 Ω	Wheatstone with d-c Amplifier	Modular construction dual range power supply, null indicator-amplifier, for 115V. 60 cycle operation.
617 Series	$\pm 0.1\%$ to $\pm 20\%$ on separate "+" and "-" selectors from a minimum resistance consistent with number of dials in use to the maximum settings.	111,111 Ω 1,111,110 Ω 11,111,100 Ω	0.1 Ω *1 Ω 10 Ω	Percent Limit	For rapid "GO-NO GO" percent limit testing. Hand or foot operated for production testing. All models also usable for direct resistance measurements. Binding post for external d-c power supply.
	$\pm 0.2\%$ $\pm 0.01\Omega$ from a minimum consistent with number of dials in use to the maximum setting.	111,111 Ω 1,111,110 Ω 11,111,100 Ω	0.1 Ω *1 Ω 10 Ω	Wheatstone	

† Except 617B and 617J $\pm 0.1\%$ $\pm 0.01\Omega$.

* Except 617G, 0.01 Ω .

For quick bonding, turn to turn, with a single application of heat or solvent . . .

Specify

**PHELPS
DODGE
BONDEZE®**

MAGNET WIRE



These successful uses of Bondeze suggest unlimited new redesign possibilities, often at overall savings.



COILS

Random-wound, layer, paper-section and solenoid coils for brakes and clutches, instruments, television, radio and other applications.

TRANSFORMERS

Paper-section, random-wound, oil-filled, air-cooled and high voltage for distribution, current, X-ray, television, radio and other applications.

MOTORS

Windings for shaded pole, series fields, instruments, induction and others.

Any time magnet wire is your problem, consult Phelps Dodge for the quickest, easiest answer!

FIRST FOR
LASTING QUALITY—
FROM MINE
TO MARKET!

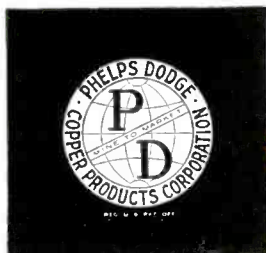

**PHELPS DODGE COPPER PRODUCTS
CORPORATION**

INCA MANUFACTURING DIVISION
FORT WAYNE, INDIANA

From
 "figures of
 speech"
 to
 "conversation"
 piece

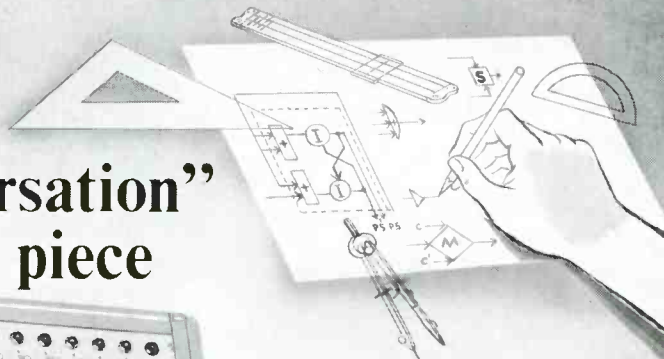

in 53 days
 with RDA*

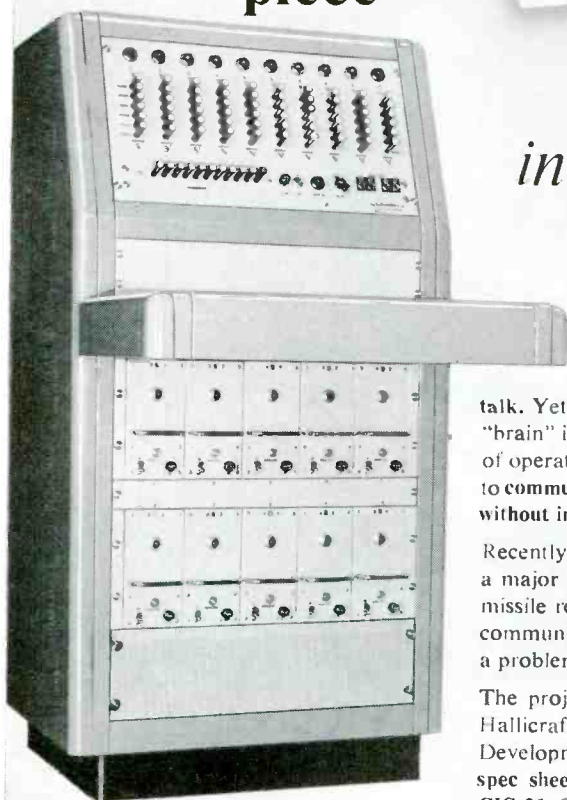

One of the few things today's large electronic computer cannot do is talk. Yet the product of its fantastic "brain" is useful only when hundreds of operators and researchers are able to communicate with perfect teamwork, without interruption or interference.

Recently Hallicrafters was asked by a major firm engaged in guided missile research to devise a superior communications system to solve such a problem. The need was urgent.

The project was assigned to Hallicrafters *RDA Division (Rapid Development Assistance). From spec sheet to finished product, the CIS-21 Computer Intercom System was designed, built and delivered in exactly 53 days.

Through more than 1,000 practical combinations of ten amplifiers, the CIS-21 provides instantaneous and perfect communication between 250 remotely stationed individuals or groups. An outstanding feature is a matrix switch that guarantees constant output regardless of the number of amplifiers in use.

Whatever your problem may be in electronics production, development or research, Hallicrafters RDA is a talking point worth considering. For information, contact us today.

The
hallicrafters
 Company

4401 West Fifth Avenue
 Chicago 24, Illinois

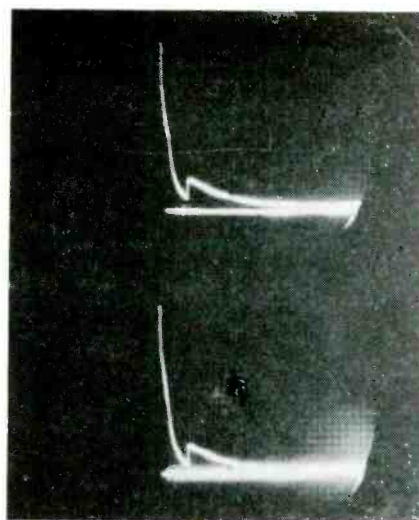

FIG. 2—Input switching transient (above) with 285-ohm and 200 μ f load. Output switching transient (below) under same conditions

current of approximately 1,400 ma. a section; for a 1-ampere regulator, which uses a total of 8 sections, a total surge current of 11 amperes is to be expected. By actual measurements the peak current was found to be 18 amperes or approximately 2.25 amperes a section.

Figure 2 (above) delineates the actual switching current transient. It takes about 70 milliseconds for the regulator to recover from the switching transient and deliver only its normal current of 1 ampere.

When the load is applied to the output side of the regulator, the output is momentarily short-circuited by the capacitive component of the load and the regulator circuit decreases the grid bias on the series regulator tubes to deliver the large current demanded. (Figure 2 (below) is a photograph of the output-switching current transient. It is similar to the input-switching transient shown in Fig. 2 (above).

Several possible remedies for preventing fuse blowouts are unsatisfactory. Fuses of the slow-blow variety have been tried and have also failed, although less frequently than regular fuses. An inductor in the unregulated supply lead capable of carrying a current of 1 ampere continuously and having the inductance required, would be large in size, weight and cost. A series current-limiting resistor and shorting switch is not a practical

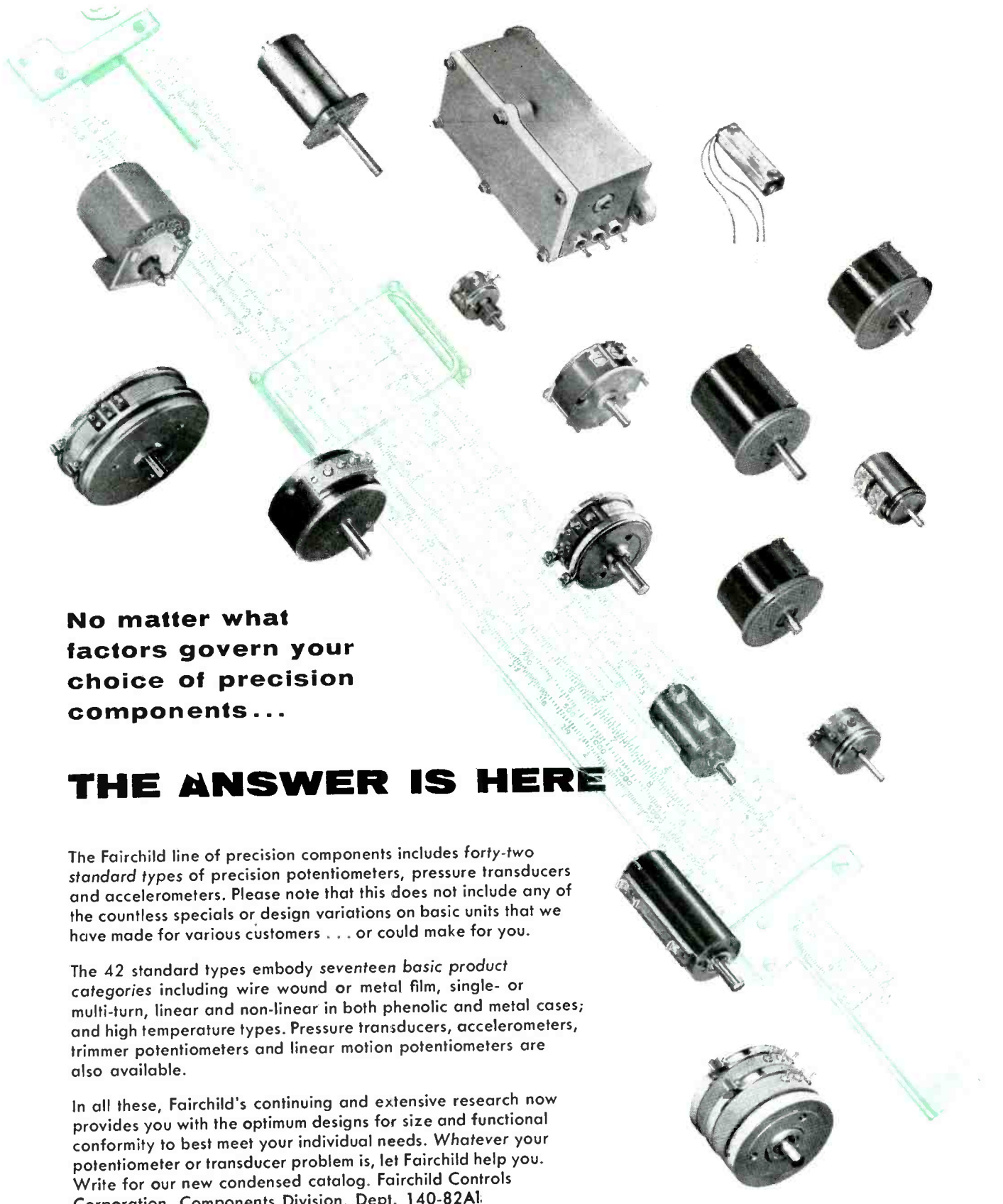

No matter what factors govern your choice of precision components...

THE ANSWER IS HERE

The Fairchild line of precision components includes *forty-two standard types* of precision potentiometers, pressure transducers and accelerometers. Please note that this does not include any of the countless specials or design variations on basic units that we have made for various customers . . . or could make for you.

The 42 standard types embody *seventeen basic product categories* including wire wound or metal film, single- or multi-turn, linear and non-linear in both phenolic and metal cases; and high temperature types. Pressure transducers, accelerometers, trimmer potentiometers and linear motion potentiometers are also available.

In all these, Fairchild's continuing and extensive research now provides you with the optimum designs for size and functional conformity to best meet your individual needs. Whatever your potentiometer or transducer problem is, let Fairchild help you. Write for our new condensed catalog. Fairchild Controls Corporation, Components Division, Dept. 140-82A1.

EAST COAST
225 Park Avenue
Hicksville, L. I., N. Y.

WEST COAST
6111 E. Washington Blvd.
Los Angeles, Calif.

FAIRCHILD
PRECISION POTENTIOMETERS
and COMPONENTS

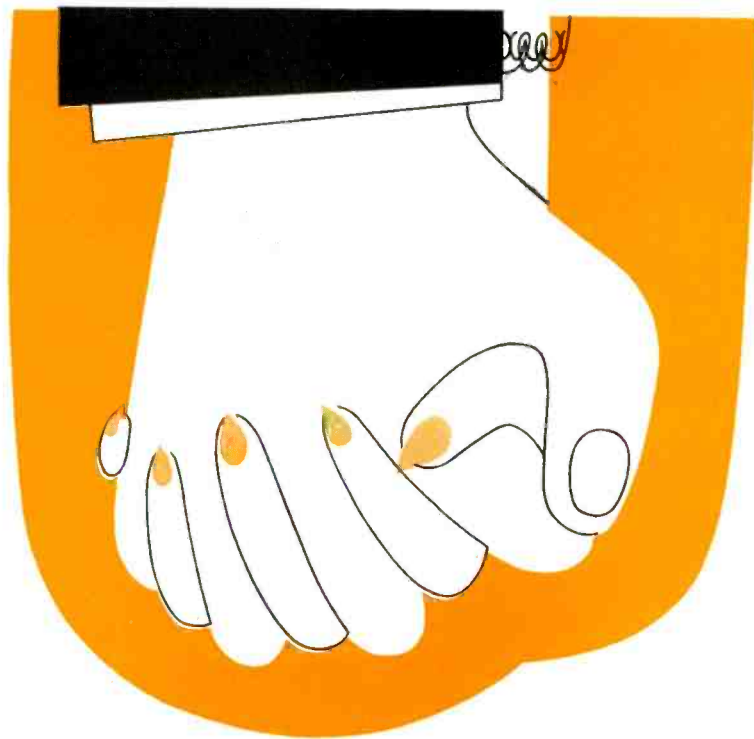

Deutsch Rack-and-Panel Connectors



MAKE PERFECT MARRIAGES



Engagements can be blind, inaccessible and frustrating in rack-and-panel installations. Yet, plugs and receptacles must join accurately for a perfect marriage.

You'll find such wedded bliss only with Deutsch Rack-and-Panel Connectors. They self-align and mate automatically...without urging or anger...without guide pins or match plates!

The mated connector is environmentally-sealed, vibration-dampened, unaffected by pressure variations. And, multiple connectors—in 7, 19, 37 or 61-pin arrangements—can be married at once, without ceremony.

Here's a wedding of parts designed for a long successful life together!

For complete information on this, or any Deutsch miniature connector, write for Catalog 1111.

The Deutsch Company

7000 Avalon Blvd., Los Angeles 3, California

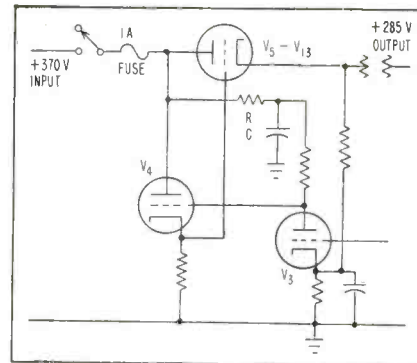

FIG. 3—Addition of R-C network to reduce input-switching transient

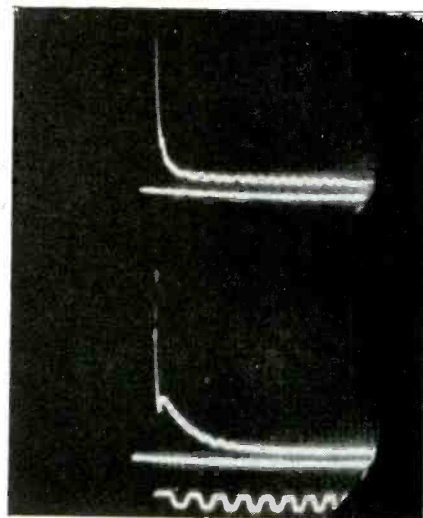

FIG. 4—Output transient using diode circuit (above) and without diode (below)

solution.

If the grids of the series regulator tubes are kept at ground potential when the unregulated voltage is turned on, any voltage appearing on the output side of the regulator will produce a negative bias on the series regulator tubes. The current in the load, therefore, will be limited by the bias voltage that is developed.

If the grid voltage on the series regulator tubes is allowed to rise slowly, the current in the load cannot increase faster than this rise in grid voltage. The capacitors loading the regulator will be charged slowly.

A transient occurs because initially the cathodes as well as the grids of the series regulator tubes are at ground potential. Until some bias is developed across the load, the 6AS7's conduct at zero bias. This transient lasts only about 15 milliseconds and a 1 ampere fuse can carry this short overload.

Figure 3 shows how the circuit

the first really new paper tubular capacitor... **AEROVOX "WHITECAP"** **"WAX-FREE"**

TYPE V84 TUBULAR CAPACITOR!

Aerovox announces the development of a WAX-FREE paper tubular capacitor with electrical characteristics surpassing all others . . . even the best molded units.

Aerovox "WHITECAP" capacitors offer a distinctive white case, completely free of wax. The absence of any wax facilitates handling and assembly procedures. No dripping and no gummed-up machines. Light in weight and clearly marked, these units will enhance the appearance of any assembly.

Aerovox "WHITECAP" capacitors are superior electrically over ALL other conventional paper tubulars including molded units. Outstanding humidity resistance . . . far greater than ever known before in units designed for radio-TV applications. Highest Insulation Resistance ever offered before in a paper tubular. Wide temperature range . . . low-power-factor. New standards of reliability backed by millions of hours of life and service tests.

Operating Temperatures — -40°C to 85°C at full voltage rating and to 100°C with voltage rating of 75%.

Power-Factor — at room temperature will not exceed 1%

Humidity — will withstand 95% relative humidity at 40°C in accordance with RETMA Specification RS164 except that exposure will be increased to 500 hours instead of 100.

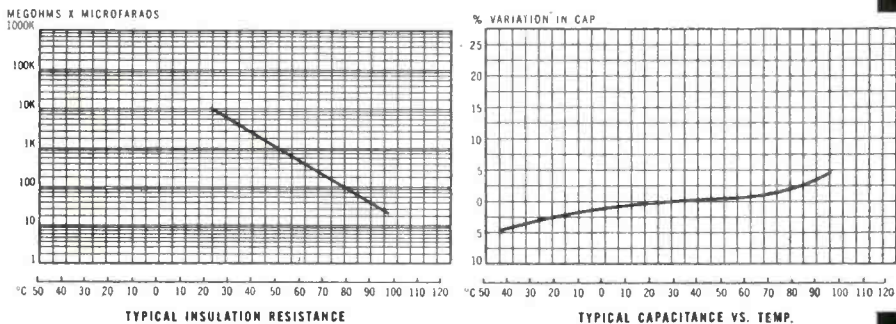

Immediate delivery on all production quantities. For full details contact your local Aerovox Sales Representative or write immediately to...

AEROVOX CORPORATION

NEW BEDFORD, MASSACHUSETTS

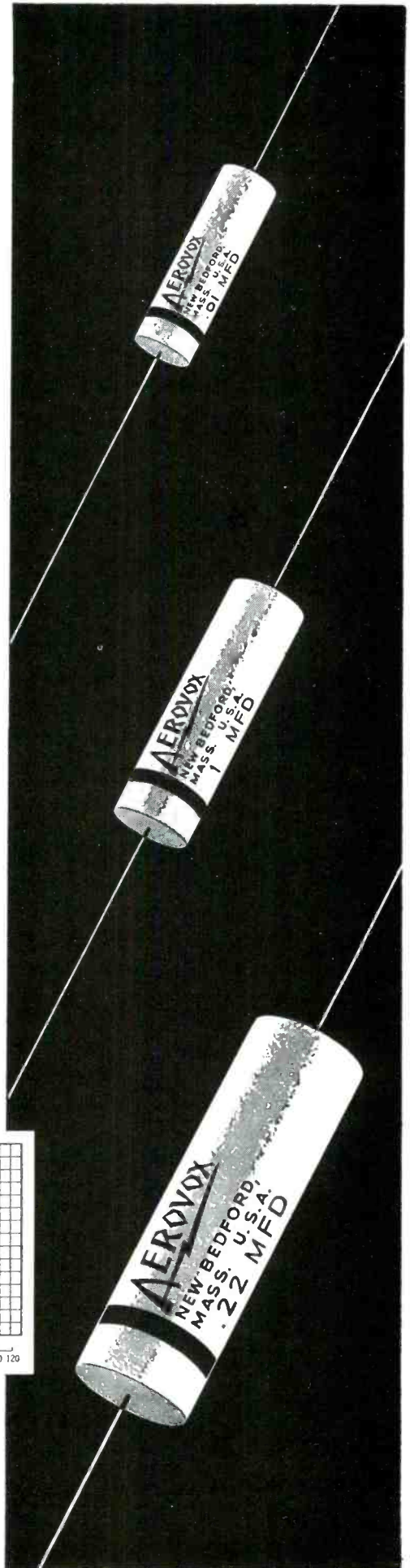

P&B PROGRESS

IMPROVED! SEALED COIL, TELEPHONE-TYPE RELAY.

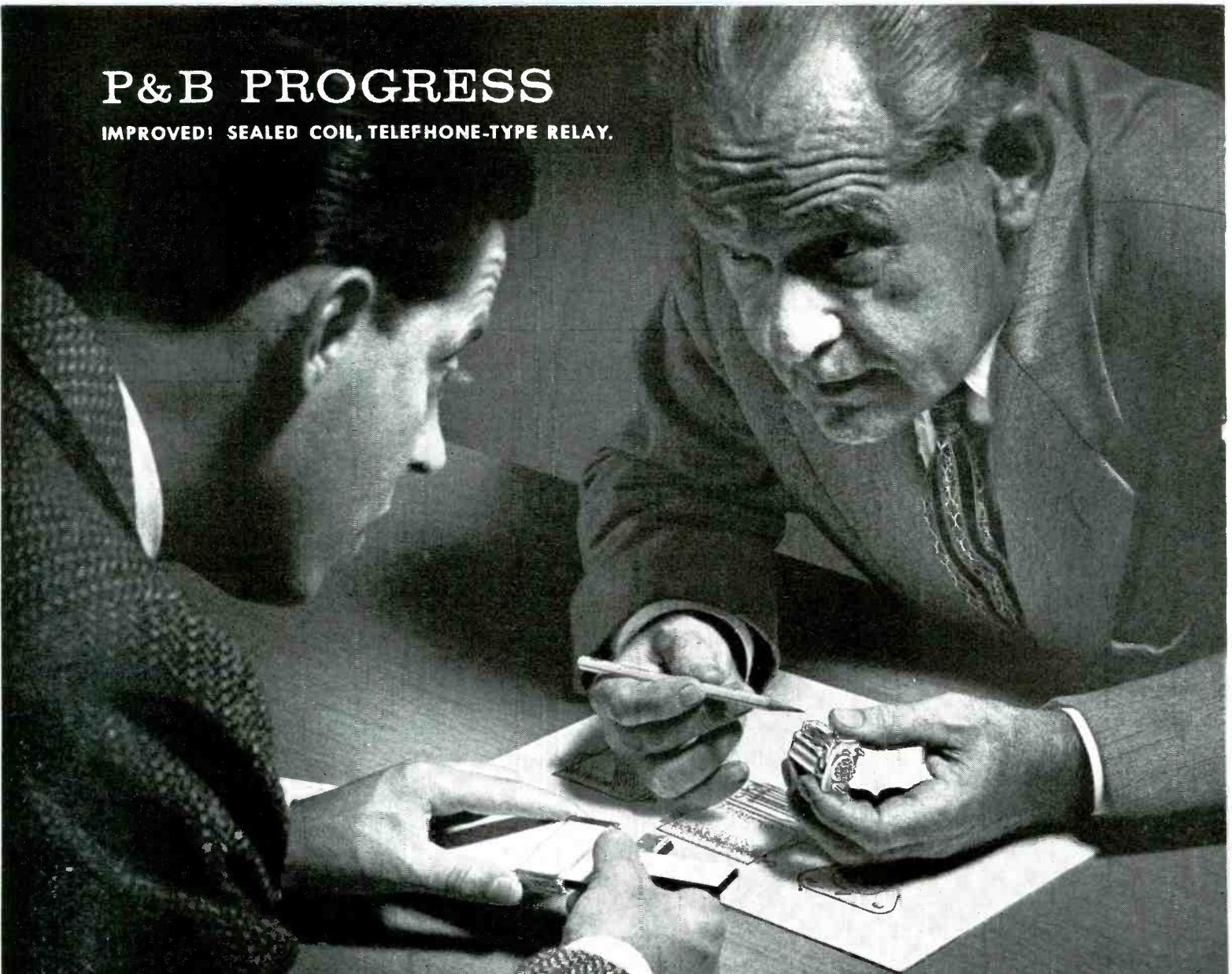

NEW! DUAL HERMETIC SEAL INCREASES RELAY RELIABILITY AND TEMPERATURE RANGE

LOOK AT THESE GREAT NEW FEATURES

New bobbinless coil saves space, permits use of more ampere turns of Teflon coated wire with no increase in coil diameter.

Hermetically sealed coil prevents gases from contaminating contacts.

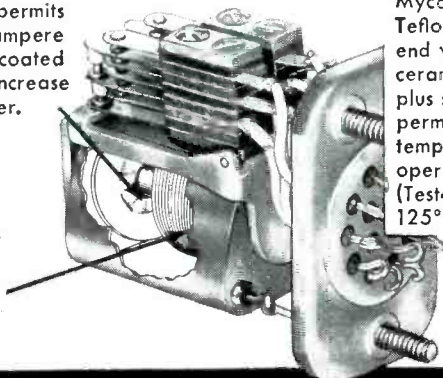

Mycalex stack, Teflon wire and end washers and ceramic pushers, plus sealed coil, permit high temperature operations. (Tested up to 125° C.)

Hermetically sealing the coil of the MH "Seal-Temp" substantially increases the reliability and life of this popular telephone-type relay. Considered a major reason for relay failure, contact contamination due to outgassing of the coil has been eliminated by this sealing process.

The "Seal-Temp" has a temperature range considerably broader than ordinary relays... from -65°C to $+125^{\circ}\text{C}$. This is achieved by constructing the stack of Mycalex, employing ceramic pushers, and by using Teflon coated wire throughout.

For applications where reliability, long life and broad temperature ranges are required, the MH "Seal-Temp" relay could well be the answer. Write, wire or call today for complete information.

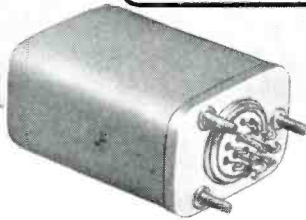
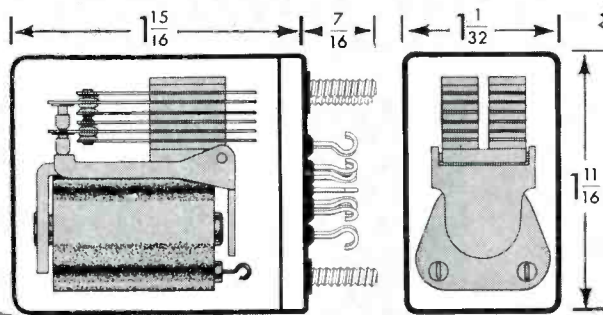

MH "SEAL-TEMP" RELAY

GENERAL: Insulating Material: Ceramic, Mycalex and Teflon.
Insulation Resistance: 1,000 meg ohms min.
Breakdown Voltage: 500 V. RMS.
Shock: 30g's.
Vibration: 5g's 55 to 500 cps.; .032" max.
excursions 5-55 cps.

Temperature Range: -65°C to $+125^{\circ}\text{C}$.
Pull-In: Approximately 75% of nominal voltage
at 25°C .

Terminals: Miniature plug in; hook end solder.
Enclosure: Short "M" Can, hermetically sealed.

CONTACTS: Arrangements: Up to 6 springs per stack. (4PDT)
Material: $\frac{1}{8}$ " Silver (others available).
Load: 5 amp. 115V. AC resistive.

COILS: Resistance: Up to 22,000 ohms.
Power: 100 mw per movable arm min.; 4 watts max.
DC at 25°C . (200 mw min. to meet shock or
vibration requirement at 25°C .)

Duty: Continuous.
Insulation: Teflon.
Coil Chamber: Hermetically sealed.

P&B STANDARD RELAYS ARE AVAILABLE AT YOUR LOCAL
ELECTRONIC, ELECTRICAL AND REFRIGERATION DISTRIBUTORS

Potter & Brumfield, inc.

PRINCETON, INDIANA

SUBSIDIARY OF AMERICAN MACHINE & FOUNDRY COMPANY

Manufacturing Divisions also in Franklin, Ky. and Laconia, N.H.

Mail the coupon
for complete engineering
data on the new
MH Series, plus new
compact catalog of
standard type relays.
If you need answers
to a specific application
problem write in detail.



Potter & Brumfield, Inc., Princeton, Indiana
Attn: T. B. White, Brig. Gen. USMC (Ret.)
Special Projects Engineer

Please send me complete engineering data on the new MH
Series Relay plus the new compact catalog of P&B standard
relays.

Name _____

Company _____

Address _____

City _____ Zone _____ State _____

of Fig. 1 was modified by the addition of resistor R and capacitor C to obtain the desired slow rise of grid voltage. The value of R is chosen such that the available plate supply voltage for V_3 is equal to or larger than it was previously. If R is made too large, the plate supply voltage for V_3 is lowered and the grid bias on the series regulator tubes will not be reduced enough

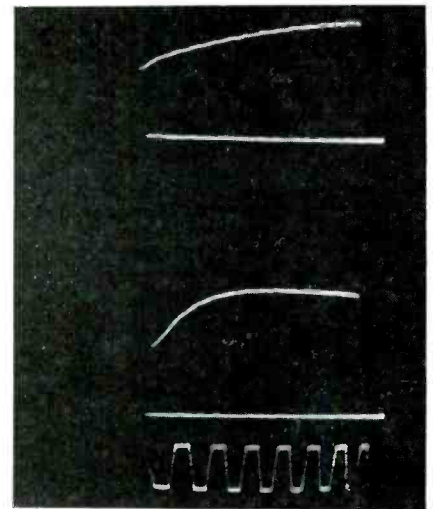

FIG. 5—Output voltage transient due to output switching with R-C network and diode (above). Transient without network or diode (below)

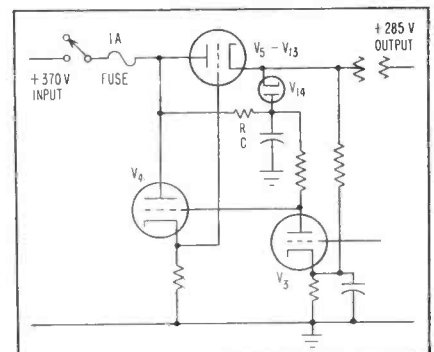

FIG. 6—Addition of diode V_{14} to reduce output switching transients

when the regulator is required to deliver large currents.

Any value between 220,000 and 560,000 ohms was found to be adequate. The value of C is chosen such that the product of RC is greater than the duration of the switching transient. It was found that by using a capacitor of $0.25\ \mu\text{f}$ and a resistor of 390,000 ohms the transient due to input switching was reduced as shown in Fig. 4. After the initial high surge, the

For Small Spaces, High Temperatures

current drops gradually to its steady-state current of 1 ampere, instead of rising again to about 4 amperes as in Fig. 2. A regular 1-ampere fuse withstands the reduced transient repeatedly without blowing-out.

Output voltage rises rapidly after the switching transient in Fig. 5. If a diode is connected as shown in Fig. 6 it will not affect operation of the regulator circuit. If R is chosen such that the plate supply voltage of V_s is equal to or greater than the voltage output of the regulator and the voltage on C tends to rise above the output volt-

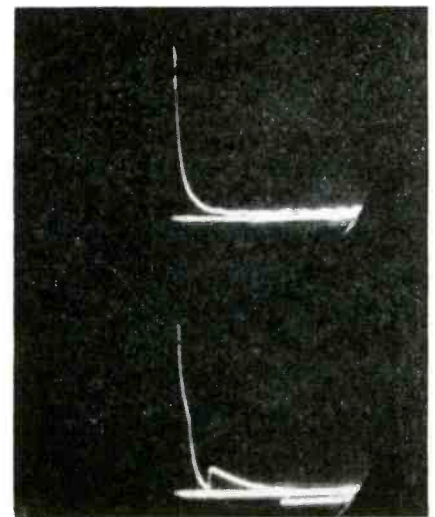

FIG. 7—Input switching transient using R-C circuit (above) and without (below)

age of the regulator, the diode will conduct. This effectively restores the circuit to that of Fig. 1.

When load is suddenly applied to the output of the regulator, the diode is automatically disconnected from the circuit while C recharges through R . The diode cathode voltage is higher than its plate voltage by an amount equal to the bias on the 6AS7 regulator tubes.

A delayed rise in output voltage is thus automatically obtained as shown in Fig. 5 and the current transient is reduced as shown in Fig. 7. A regular 1 ampere fuse can now be used when either method of switching is used.

A neon lamp such as a type NE-2 can be used in place of the diode. However the C will not be discharged as much with the neon lamp circuit as with the diode circuit, because the neon lamp has a voltage drop in the neighborhood

GAMEWELL RVG SERIES Miniature **PRECISION** **POTENTIOMETERS**

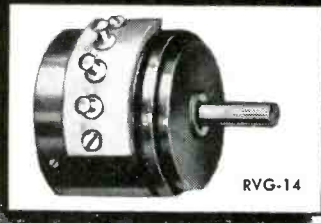

RVG-14

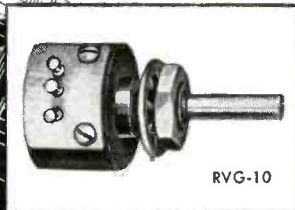

RVG-10



RVG-17XS

These Gamewell pots — $\frac{5}{8}$ " , $\frac{7}{8}$ " and $1\frac{1}{16}$ " — provide superior characteristics in miniature size . . . ideal for high temperatures and other environmental extremes. All have anodized aluminum bodies, stainless steel shafts, excellent linearity and meet MIL-E-5272A specs as they apply. RVG-17XS has a specialized arrangement which produces sine-cosine functions with unique precision and smoothness.

For dependable performance under rugged environmental conditions and severe space restrictions, specify one of these RVG Precision Potentiometers. Many special features and modifications are also available to meet your specific need. Write or call for details.

THE GAMEWELL COMPANY
NEWTON UPPER FALLS 64, MASS.



PRECISION POTENTIOMETERS

GA6-18

Check these dimensions
for reducing
"package" size

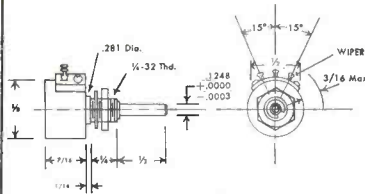

RVG-10

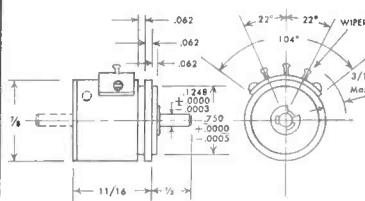

RVG-14

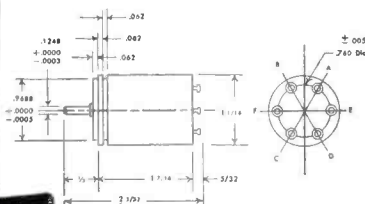

RVG-17XS

SPECIAL!

Send for New catalog with data on complete line.

ALSiMAG[®] ALUMINA CERAMICS

*have more to
offer!*

WIDEST VARIETY of Alumina materials available from any source. Vitrified or porous compositions . . . 85% and higher. Industry approved . . . accurately controlled. Greater freedom for designers who can usually find in our special purpose ALSiMag Alumina materials the exact combination of characteristics desired. Custom formulations for unusual requirements.

SUPER PROPERTIES: High strength—tensile, flexural, compressive. Superior electrical characteristics at high temperatures and frequencies. Rugged resistance to thermal shock, mechanical shock, vibration, abrasion. Hardness up to 9 on Mohs' scale. Chemically inert. Permanently rigid. Withstand radiation bombardment without producing contaminants.

OTHER PLUS FACTORS: Precision tolerances. Wide range of physical sizes and shapes, standard and custom designs. Fast delivery in any quantity. Prototype service if desired . . . enables designer to test performance under actual operating conditions before investing in tooling. Continuing research to satisfy customers' current and future requirements.

Blueprint or sketch, with details of operation, will bring you complete information on the ALSiMag Alumina best suited for your application. NEW Bulletin 575 covering several of the most popular ALSiMag Aluminas sent on request.

A Subsidiary of
Minnesota Mining and
Manufacturing Company



**AMERICAN LAVA
CORPORATION**

CHATTANOOGA 5, TENN.

56TH YEAR OF CERAMIC LEADERSHIP

For service, contact Minnesota Mining & Manufacturing Co. Offices in these cities (see your local telephone directory): Atlanta, Ga. • Boston, Newton Center, Mass. • Buffalo, N. Y. • Chicago, Ill. • Cincinnati, O. • Cleveland, O. • Dallas, Texas • Detroit, Mich. • High Point, N. C. • Los Angeles, Calif. • New York, Ridgefield, N. J. • Philadelphia, Pa. • Pittsburgh, Pa. • St. Louis, Mo. • St. Paul, Minn. • So. San Francisco, Calif. • Seattle, Wash. Canada: Minnesota Mining & Manufacturing of Canada, Ltd., P. O. Box 757, London, Ont. All other exports: Minnesota Mining & Manufacturing Co., International Division, 99 Park Ave., New York, N. Y.

A New Concept of TIME . . .



... this Complete NEW Line of HAYDON* TIMING MOTORS

Here is a complete line of timing motors that includes the right choice for every APPLICATION . . . entirely re-designed for finer performance. Features include: slower basic rotor speed (450 rpm), controlled lubrication, total enclosure, smaller size, superior accuracy, quieter operation and longer life.

HYSTERESIS . . . the ideal general-purpose motor.

INDUCTOR . . . extra torque (30 ounce inches) for display and other heavy-duty jobs.

CLUTCH . . . allows automatic re-setting without external clutches.

REVERSIBLE . . . a hysteresis type with 2 coils, each producing opposite rotation.

DIRECT CURRENT . . . a permanent magnet type for 6 to 32 volts.

400 CPS . . . miniature and heavy-duty models for airborne instrumentation.

FOR COMPLETE INFORMATION, write today for new catalog . . . or contact the HAYDON Field Engineer nearest you.

*Trademark Reg. U.S. Patent Office

HAYDON
AT TORRINGTON
HEADQUARTERS FOR
TIMING

A SUBSIDIARY OF GENERAL TIME CORPORATION

HAYDON Manufacturing Company, Inc.
2435 ELM STREET, TORRINGTON, CONN.

of 50 volts and a higher internal resistance than the diode. The transient due to output switching when using a neon lamp is greater than the transient obtained when using a diode. Although ordinary fuses blow when a neon lamp is used, slow-blowing fuses withstand repeated switching transients.

The work described was done while the author was with Tel Instrument Co., Inc., Carlstadt, N. J.

Magic Tee Techniques Refine Load Matching

ALAN C. MACPHERSON
Solid State Electronics Branch
U. S. Naval Research Laboratory
Washington, D. C.

AN ideal magic tee, as shown in Fig. 1, will give no output power from arm 3 when arms 1 and 2 are loaded equally and power is fed into arm 4. This characteristic is usually used to match a variable load *A* to an arbitrary fixed load *B*. It is apparent that unsymmetrical tees used in the same manner will not give the desired results. This difficulty can be eliminated by utilizing another variable load *C* and performing a two-step matching procedure.

Initially, loads *C* and *B* are placed on arms 1 and 2 respectively and load *C* adjusted until minimum power output is measured at arm 3. When this is accomplished, load *B* is replaced by load *A* and the latter adjusted until the output is nulled once again.

Since power input and detector sensitivity are finite, the reflection coefficients of the loads may not be identical. The limits of this error can be evaluated by various methods (ELECTRONICS, Sept. 1950, p 190). Although small defects in the tee cause a slight decrease in sensitivity while adjusting load *A*, the output is not significantly affected.

► **Sliding Loads**—Adjustable terminations have been developed which slide into waveguides and permit adjustment of the phase of the reflection coefficient independent of the amplitude. For matched termination, adjustments are made on

**STOCK
DELIVERY**

PROVEN...

RELIABILITY ✓

ECONOMY ✓

VERSATILITY ✓



**FXR Universal
KLYSTRON
POWER SUPPLY**

Whether meter or millimeter measurements are contemplated, no microwave laboratory is complete without the FXR 'Z815B' Universal Klystron Power Supply. Unsurpassed for proven dependability and versatility, this supply incorporates the many qualities that have made FXR craftsmanship and 'know how' ... the standard in the industry.

Price \$1350
FOB Woodside, N. Y.

FXR TYPE Z815B - SPECIFICATIONS

OUTPUT				MODULATION						
TYPE	VOLTAGE (volts)	CURRENT (milliamperes)	INTERNAL IMPEDENCE (ohms)	ADDITIONAL SPECIFICATIONS	TYPE	FREQUENCY RANGE (cps)	NOMINAL VOLTAGE (volts)	RISE TIME (microseconds, max.)	FALL TIME (microseconds, max.)	
Beam	200 to 2030 1800 to 3630	0 to 125 0 to 100 to 2500V 250 W to 3600V	0.5 max. from 0 to 10,000 cps	Voltage Dial Accuracy: ± 1% Resolution: 0.5 volts Regulation: 0.03% from 105 to 125 volts Ripple: 3 mv rms, max.	Square Wave	250 to 2500	0 to 200	1.0	1.0	
Reflector	Negative 0 to 100V		1,000,000 min.		Pulsed Wave	1 to 10 microseconds pulse width	0 to 200	1.0	1.0	
Control Grid	Positive 0 to 15V Negative 0 to 30V	0 to 5	0 to 30,000	Regulation: 0.03% from 105 to 125 volts Ripple: 3 mv rms, max.	Sine Wave	line frequency	0 to 200			
Filament	6.3	3 amperes		Unregulated	Saw Tooth Wave	40 to 120	0 to 200	Variable	30	
DIMENSIONS (inches)	Width: 21 3/4 Height: 15 3/4 Depth: 18	OVERLOAD PROTECTION	AC Line Fuse, 8 amperes, (both sides of line) HV Line Fuse, 4 amperes DC HV Line: Variable overload relay 25, 65, & 125 ma or as desired by user			POWER	105 to 125 volts, 50-60 cps, 300 to 800 watts			

Data subject to change without notice.



Electronics & X-Ray Division

FR MACHINE WORKS, INC.

26-12 Borough Place, Woodside 77, New York



Write Today...
for your new catalog of
Precision Microwave
Test Equipment.

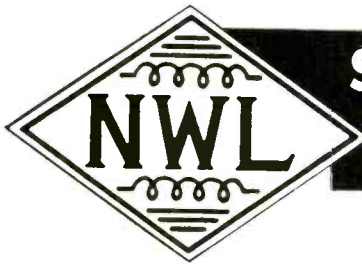

SPECIALISTS in TRANSFORMERS

Here is Another
NOTHELFER Special

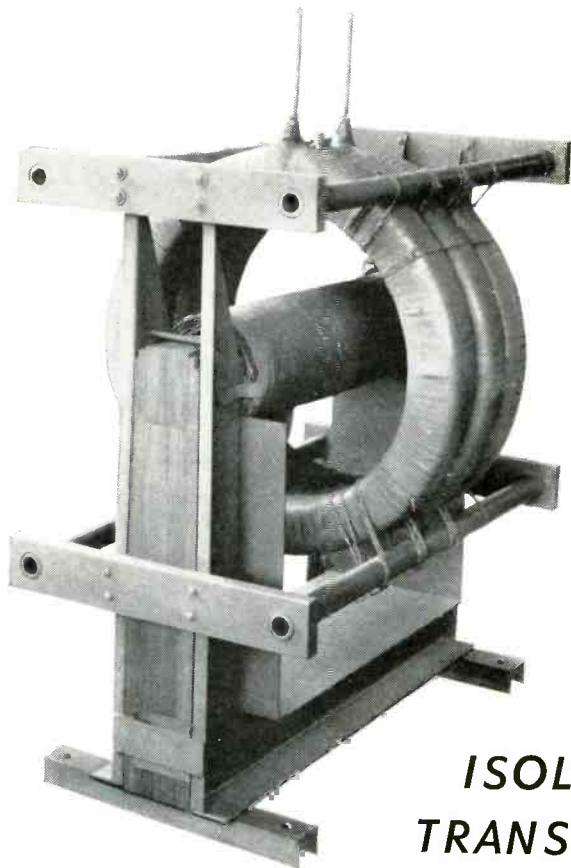

ISOLATION TRANSFORMER

for 110 KV DC Test, Air Insulation for circuit isolation at 70 KV DC Working. The unit illustrated is a 3 KVA Capacity, and is 30" overall height. Designed for full time, continuous duty.

Notthelfer

WINDING LABORATORIES, INC.

P. O. Box 455, Dept. 101, TRENTON, N. J.

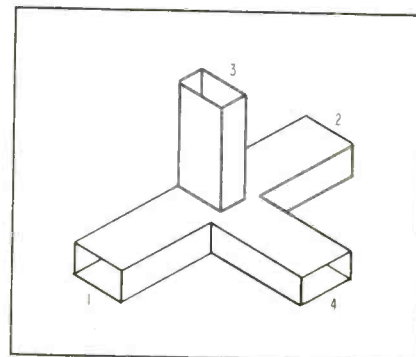

FIG. 1—Magic-tee network used to match variable load to an arbitrary fixed load

the load permitting it to slide back and forth without producing a discernible indication at the detector. When set up in this manner, the termination is reflectionless within the sensitivity range of the detector.

The ideal magic tee provides a sensitive means for making adjustments simultaneously on two sliding loads. The preliminary setup consists of placing sliding loads X and Y in arms 1 and 2 respectively, mounting a sensitive matched detector in arm 3 and applying power to arm 4. When this is accomplished load X is slid back and forth changing the phase angle of the reflection coefficient which, in turn, varies the power output at arm 3 as indicated by

$$P_3 = \frac{P_4}{4}$$

$$\left[|S_x|^2 + |S_y|^2 - 2|S_x||S_y|\cos(\theta_x - \theta_y) \right]$$

where P_3 is the power output at arm 3, P_4 is the net input power at arm 4, S_x is the reflected coefficient of sliding load $X = S_x \exp(j\theta_x)$, S_y is the reflected coefficient of sliding load $Y = S_y \exp(j\theta_y)$, θ_x is the phase angle of S_x and θ_y is the phase angle of S_y .

Maintaining zero power output at arm 3 while positioning X and Y terminators requires careful adjustment of the loads. However, since tees have defects, it is practical to adjust the loads until some power is delivered to the detector. This power remains constant while loads X and Y are positioned. Although S_x and S_y are small, this adjustment is sensitive because a small variation of θ_x or θ_y produces a large change in P_3 .



Model DOS

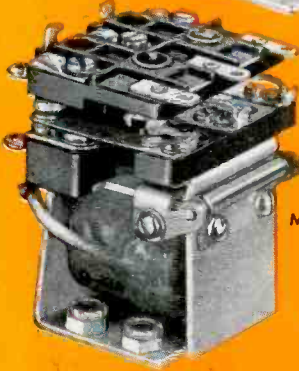

Model DO

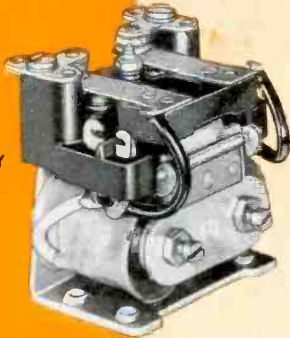

Model DOSY

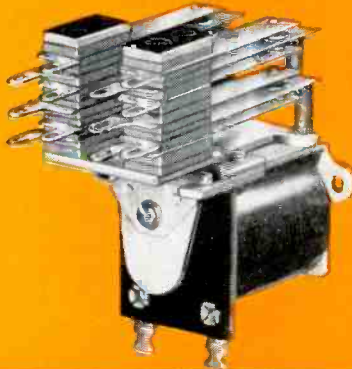

Model CRU

specify **OHMITE®** relays where dependability is a must!

65 types in four stock models . . .

OHMITE RELAYS provide the same traditional dependability that electronic engineers in industry have come to expect of Ohmite components. Ohmite all-purpose relays have proved their exceptional ruggedness and long life in years of service. Four popular stock models—DOS, DOSY, DO, and CRU, in 65 different types, are available. Models DO and DOS fill many industrial needs for a compact, lightweight relay that handles power loads usually requiring much larger, heavier units. They are particularly adaptable to aircraft and mobile equipment where severe shock and vibration are encountered. The increased operating sensitivity of Model DOSY relay, equipped with twin coils, makes the DOSY adaptable to a wide range of electronic control circuits, such as plate circuit controls. At 115 VAC or 32 VDC, noninductive load, Models DOS and DOSY have contact ratings of 15 amp; Model DO, 10 amp; and Model CRU, 5 amp. Available in a wide range of coil operating voltages and contact combinations.

countless variations in made-to-order

models In addition to the four stock models in 65 types mentioned above, Ohmite has seven standard types of relays available promptly made to order. These units are available in many contact combinations and coil voltages. They are also available in hermetically sealed or dust-protective enclosures. Ohmite engineers will be happy to make a recommendation designed to meet your needs.

SEND FOR CATALOG R-11

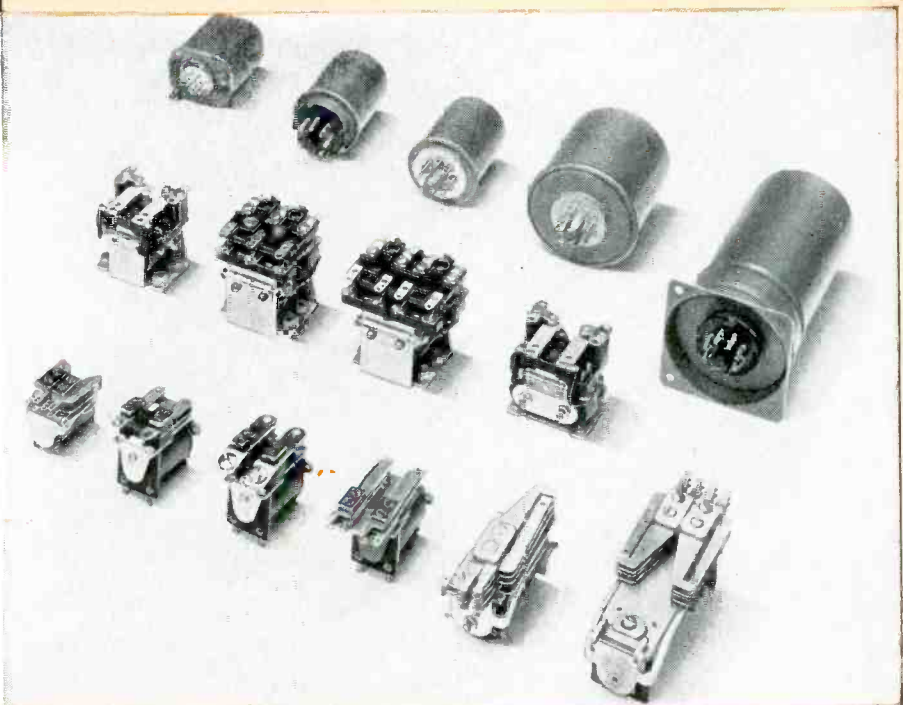

BE RIGHT WITH

OHMITE®

RHEOSTATS • RESISTORS • RELAYS • TAP SWITCHES
TANTALUM CAPACITORS • VARIABLE TRANSFORMERS

OHMITE MANUFACTURING COMPANY
3610 Howard Street, Skokie, Illinois

Blank Cards Serve as Printed Circuit Breadboards

By L. LINDGREN and A. OSBORN
*Aeronautical Division
Minneapolis-Honeywell Regulator Co.
Minneapolis, Minn.*

PRINTED-CIRCUIT breadboards with connector tabs expedite transition from breadboard to etched wiring.

Simulation of the layout configuration of printed circuits on cards allows for the flexibility of changing and modifying circuits still in the breadboard stage and provides models for the fabrication of finished etched wiring cards.

A blank card with printed connector tabs was made from an etched card originally intended for an altogether different circuit. After this card was cut to the exact size desired, a circuit layout was executed simulating a printed circuit. This card could then be inserted in a standard printed circuit connector mounted in the system model, enabling tests to be made.

Simulated cards may be used as models by a layout draftsman who

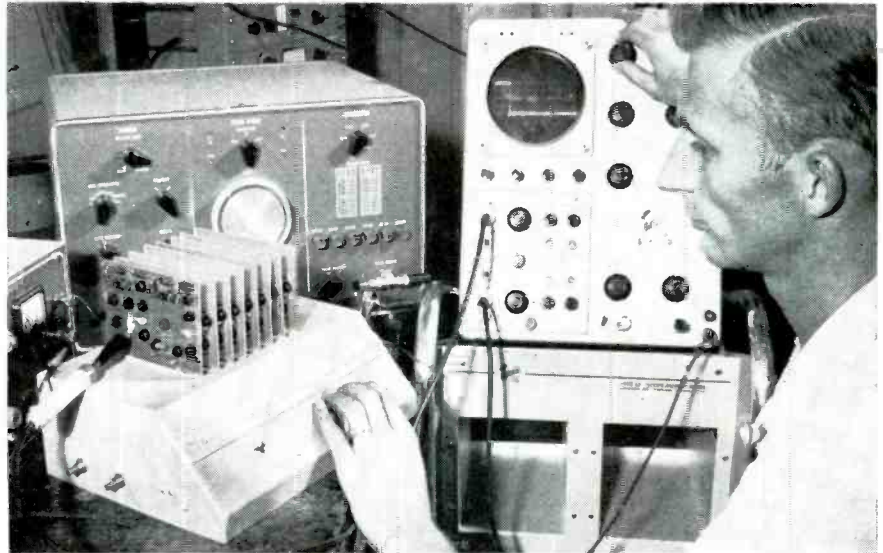

Testing breadboards put together on cards having same printed connector tabs as will go on final printed circuits for digital computer

is inexperienced in layout and unfamiliar with components used, since all parts and wires are already essentially in final positions.

The model provides a fast check reference for detecting errors in drafting layout.

For small quantities, the bread-

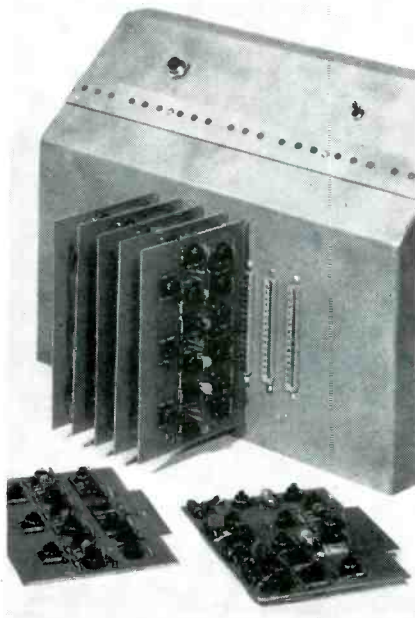

Simulated printed circuit cards can be plugged directly into standard printed circuit connectors to make up prototype model of output display register for digital computer

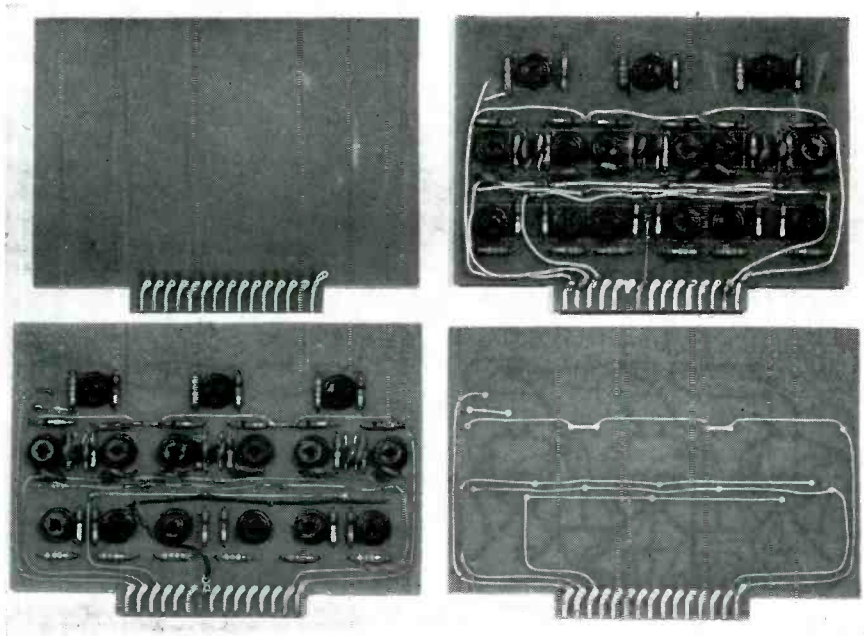

Four steps in designing and producing printed circuit card. Upper left—blank card with etched connector tabs. Upper right—simulated printed circuit card, on which parts have been mounted by hand in final positions and insulated wires run along routes of final etched wiring. Lower right—final card with etched wiring on both sides. Lower left—final card with components installed, ready for use



"We are sold on Kester '44' Resin-Core Solder, Jim. It's the fastest acting solder we have ever seen."

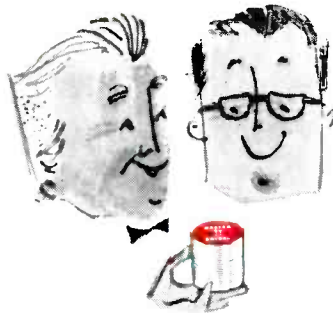

"Been using Kester Flux-Core Solder for almost half a century, Tom; nothing like it."



"Kester Solder spools are always marked with the exact alloy, Joe; no code markings."

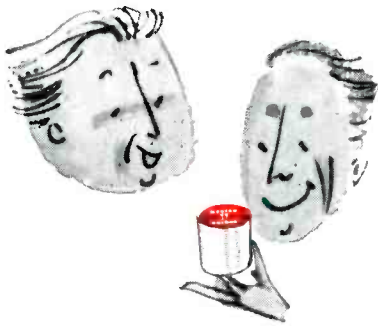

"Nothing like Kester Solder, Fred, for keeping costs in line."

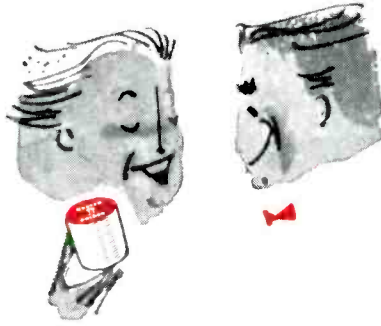

"Our girls swear by Kester, Bert; they claim soldering is much easier."

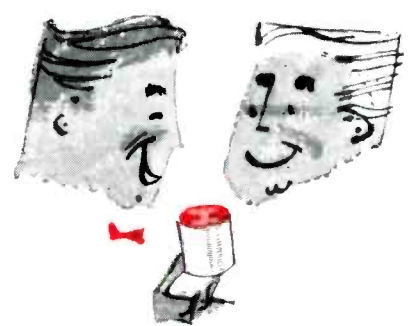

"Kester 'Resin-Five' Core Solder is the choice for our production, Paul."

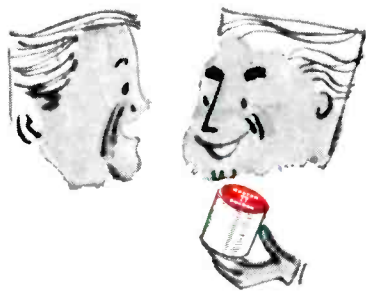

"Our work goes much faster now, Bill, since we switched to Kester Solder."

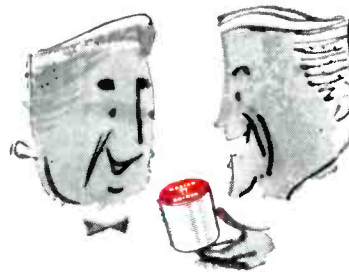

"We had a tough soldering job, Harry, but Kester engineers licked it in a hurry."



SEND TODAY for your free copy of the Kester book, "Solder . . . Its Fundamentals and Usage" . . . 78 pages of technical information.



HOW THE WORD GETS AROUND

You hear comments like these everywhere informed people in the electronics industry get together to "talk shop." It's a fact . . . there is nothing quite like Kester Solder. And that's why it's so universally popular.

KESTER SOLDER

Company

4204 Wrightwood Avenue • Chicago 39, Illinois
Newark 5, New Jersey • Brantford, Canada

boards may be used in lieu of printed circuits. A complete simulated board model of average complexity

can be turned out in 2 days and converted to printed circuitry in about 2 weeks, whereas conventional trans-

sition from diagram to printed circuitry required almost twice that time and much greater expense.

Molding Pressure Seals for Wire Bundles at Bulkheads

SEALS FOR ELECTRICAL wiring passing through bulkheads that must withstand critical pressure and

temperature differentials are now molded in place at Douglas Aircraft Co. by a new method based

on Thiokol liquid polymers.

This method has been adopted for the Douglas F4D Skyray be-

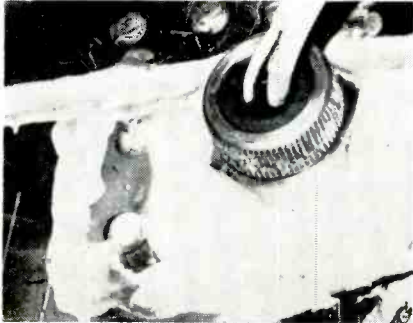

Former method of using connectors

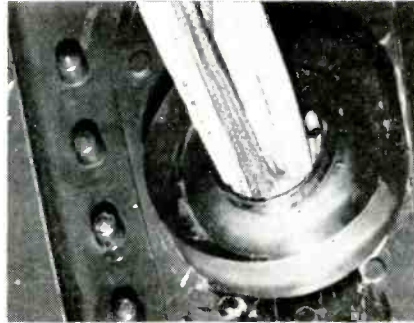

Plastic mold in place, ready for pouring

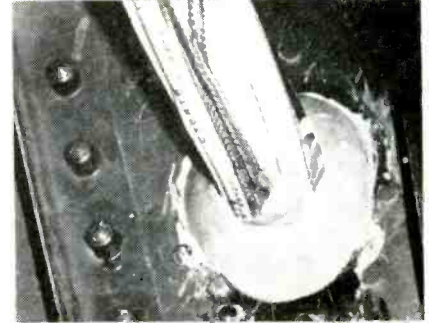

Completed hemispherical rubber seal

Design of the Month: RARE-EARTH STRAIN CELLS

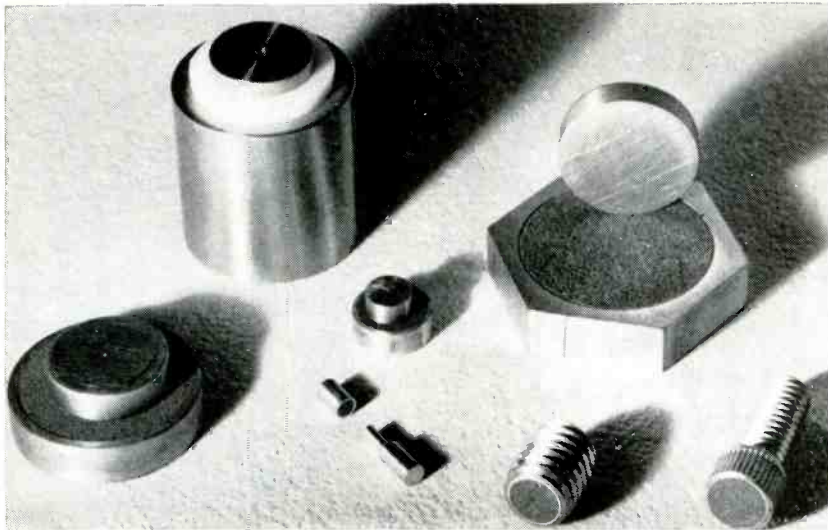

New chemical material sensitive enough to detect footsteps of a fly, made by processing intermetallic resins and rare earths with zirconium tetrachloride, is basis of Celab line of pressure transducers announced by Clark Electronic Laboratories, Palm Springs, Calif. Over 30 different compositions already available give no-load resistance values ranging from a few ohms to hundreds of megohms, each dropping almost linearly as pressure is applied

PRESSURE CELLS—Brass cup holding powder-like crystalline material serves as one electrode, while brass disk centered over material serves as other electrode and as means of applying pressure. In typical small unit, force of 1 lb gives resistance change of 500,000 ohms; for largest unit in stock, 15,000 psi gives 25-ohm change. Resistance is independent of temperature up to 300 F. Stock cells may be operated continuously at 500 F, specials up to 1,100 F. Metal shell will melt before cell material is damaged; upon cooling from red heat, original rating of cell is restored

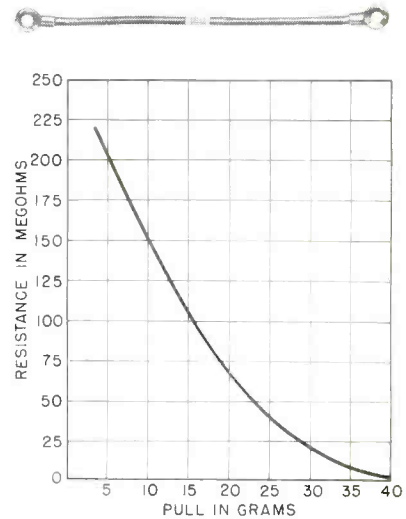

IDEAS FOR USE—For explosion gaging, cells have been made with shock rating of 250,000 psi. Smallest versions have been used as cardiac catheter for measuring blood pressure inside heart. High-sensitivity cells, changing from practically zero ohms on no load to near infinity at full pressure, can serve as nonmechanical relays. All sizes can be adapted for measuring gas and liquid pressures. Standard units respond up to 60 cps, specials up to 400 cps, for vibration pickups. Pressure-sensitive powder is also available in bulk

STRAIN CELLS—Sensitivities up to 1 megohm per gram of tension are achieved with same basic composition. Construction is ultimate in simplicity; powdered material with binder is used like tape to separate stripped ends of stranded insulated hookup wire, positioned as for lap splice so that pull on wire is transmitted to material between ends to cause change in resistance. One model, shown above, drops from 220 megohms to about 3 megohms for only 40-gram pull. Applications include wrapping around wrist for sensing pulse action

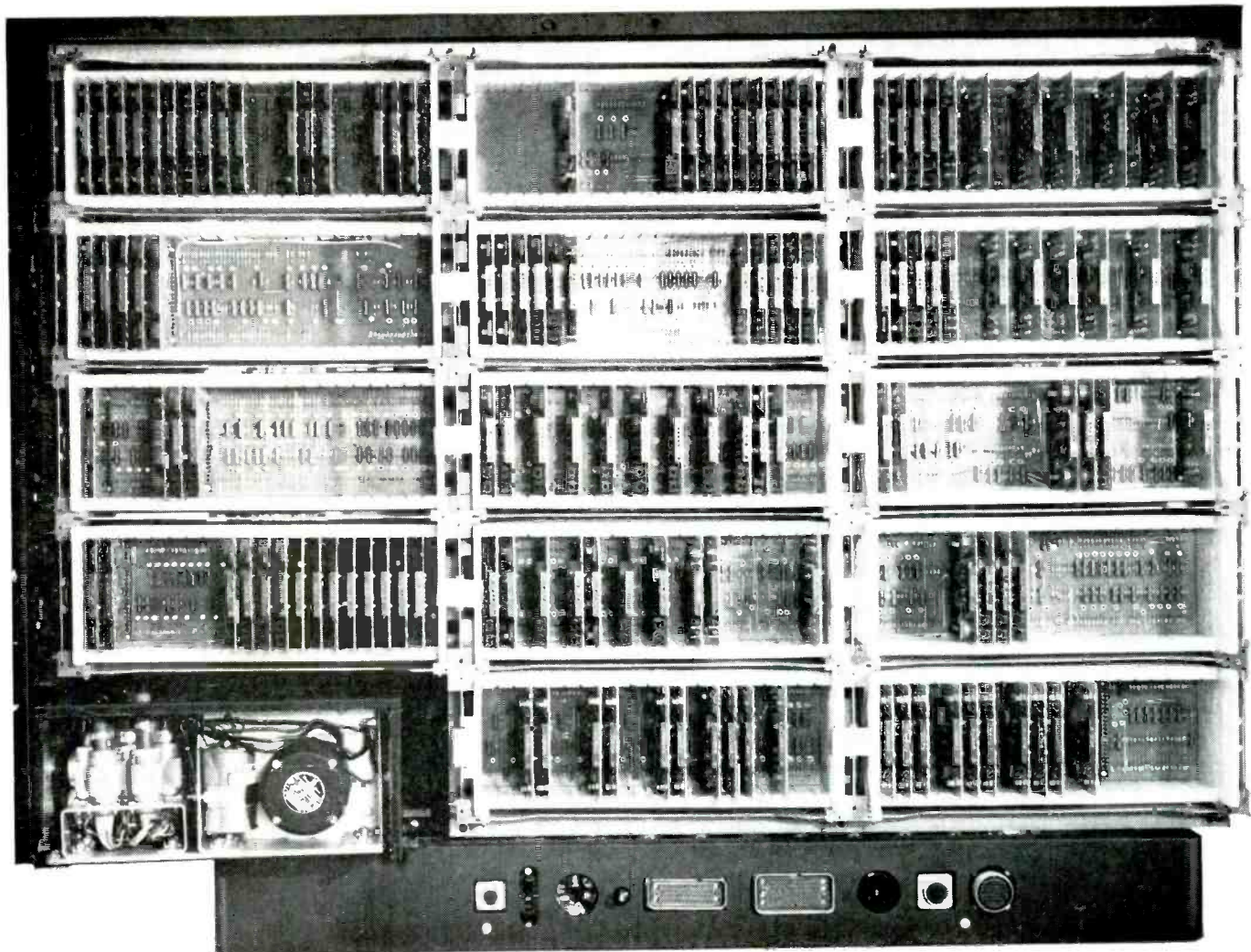

The Role of **PRODUCT ENGINEERING** in Systems Work

It has become characteristic of modern weapons systems that they are required to operate under severe environmental conditions, as well as to meet stringent weight and space limitations. Moreover, the complexity of many of these systems poses additional difficult reliability problems, while at the same time the increasingly critical consequences that depend on the proper functioning of the typical system logically call for a *higher* degree of reliability than previously achieved. The same is true of certain electronic systems for industrial applications, such as the Ramo-Wooldridge digital control computer, some of whose design features are shown above.

Meeting all of these requirements is in large part the responsibility of product engineering. Generally speak-

ing, product engineering starts with a system or subsystem at the breadboard stage and transforms it into the final product, which in addition to meeting all of the requirements previously stated, must be practical to manufacture and to maintain. Such creative productizing requires the development of ingenious mechanical design features, a thorough knowledge of circuit design and component reliability, and a broad familiarity with materials and manufacturing processes.

At Ramo-Wooldridge, the product engineer is an essential member of the research and development team which has the full responsibility for creating new systems, from the initial theoretical studies on into the manufacturing stage. Engineers experienced in product engineering are invited to explore the variety of openings which exist at Ramo-Wooldridge in such fields as airborne electronic and control systems, communications and navigation systems, digital computers and control systems, and electronic instrumentation and test equipment.

The Ramo-Wooldridge Corporation

5730 ARBOR VITAE STREET • LOS ANGELES 45, CALIFORNIA

cause of difficulties involved in using standard aluminum plug-in receptacles. The technique consists of passing wires through the opening of the bulkhead and then injecting the Thiokol liquid polymer-based compound into hemispherical plastic molds around the wires to form the seals. This compound converts entirely to a rubber at room temperature without shrinkage,

and has excellent adhesion to glass, metals and plastics. It will withstand temperature cycling from - 65 F to approximately 300 F.

Hermetic sealing of wire through bulkheads can be applied at any time during plane assembly or in the field. Weight per seal is reduced from 18 ounces to 1½ ounces, and cost is only 1/70th of that with previous methods.

Machine Inserts Components In Boards

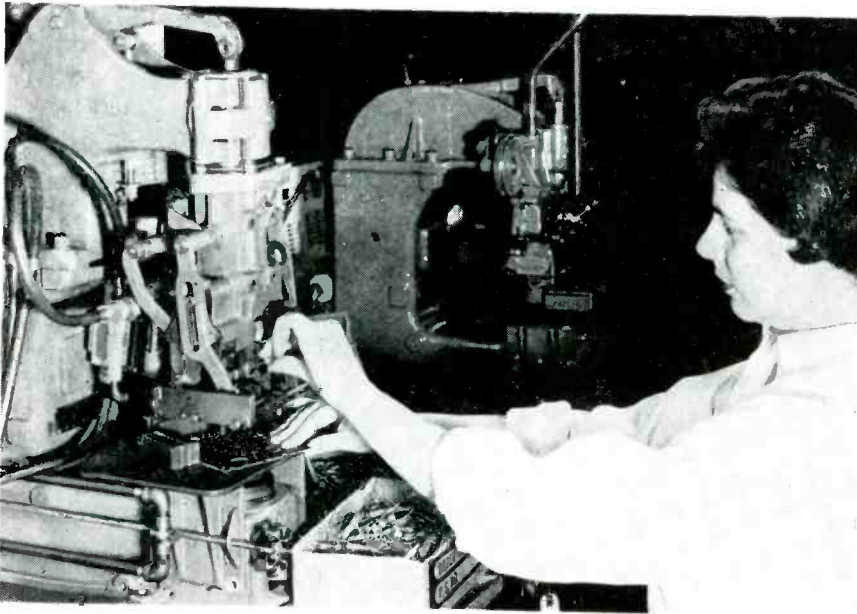

Operator drops in component with left hand while positioning board against magnetic stops on table of semiautomatic machine with right hand

ABILITY TO HANDLE axial-lead components ranging from small diodes to large tubular capacitors without precutting of leads is one feature of a new single-station component inserter developed by United Shoe Machinery Corp. of Boston. The operator simply moves a printed wiring board up to stops with her right hand, drops in a component with her left hand and presses the treadle switch with her foot. Under pneumatic power, the component is transferred from the loading station to a mechanism which straightens and corrects

them for eccentricity. The leads are then automatically cut to the proper length, bent into a shape of a staple, inserted into the correct prepunched hole in the wiring board, then clinched underneath.

This new approach to semiautomatic component assembly for short-run production eliminates the need for special packaging or preliminary preparation of components. Rectangular components or irregularly shaped small coils can be handled without difficulty. With hand feed, an operator can insert up to 700 components per hour.

Wrappable Magnetic Foil Shields Relays

NEW DEAD-SOFT magnetic shielding foils can be cut to any required size or shape with ordinary scissors

and wrapped tightly around a relay, vacuum tube or other component, to provide low-level shielding

ENGINEERS

... cross new frontiers in system electronics at THE GARRETT CORPORATION

Increased activity in the design and production of system electronics has created openings for engineers in the following areas:

ELECTRONIC AND AIR DATA SYSTEMS Required are men of project engineering capabilities. Also required are development and design engineers with specialized experience in servo-mechanisms, circuit and analog computer design utilizing vacuum tubes, transistors, and magnetic amplifiers.

SERVO-MECHANISMS AND ELECTRO-MAGNETICS Complete working knowledge of electro-magnetic theory and familiarity with materials and methods employed in the design of magnetic amplifiers is required.

FLIGHT INSTRUMENTS AND TRANSDUCER DEVELOPMENT Requires engineers capable of analyzing performance during preliminary design and able to prepare proposals and reports.

FLIGHT INSTRUMENTS DESIGN Requires engineers skilled with the drafting and design of light mechanisms for production in which low friction, freedom from vibration effects and compensation of thermo expansion are important.

HIGH FREQUENCY MOTORS, GENERATORS, CONTROLS Requires electrical design engineers with BSEE or equivalent interested in high frequency motors, generators and associated controls.

Send resume of education and experience today to:
Mr. G. D. Bradley

THE GARRETT CORPORATION

9851 S. Sepulveda Blvd.
Los Angeles 45, Calif.

DIVISIONS:

AiResearch Manufacturing
Los Angeles
AiResearch Manufacturing
Phoenix
AiResearch Industrial
Rex - Aero Engineering
Airsupply - Air Cruisers
AiResearch Aviation
Service

Electronic Cooling Package... by AiResearch



SPECIFICATIONS OF TYPICAL AIRESEARCH COOLING PACKAGE

Air Flow	60 CFM
Fan Air Inlet Pressure	18 PSIA
Fan Pressure Rise	1.2 inches water
Heat Exchanger Pressure Drop	1.0 inches water
Liquid	Water
	Methanol
	(70% Methanol)
Liquid Flow	0.4 GPM
Heat Rejection*	300 Watts
Fan Power	30 Watts, 110 V., single phase, 400 cycle
Package envelope dimensions	7 x 6 x 3 inches
Package wet weight	2.5 lbs.

*Assumes Class A (85°C.) electronic components, liquid inlet temperature to heat exchanger, 55°C. Includes heat from fan motor.

This high performance AiResearch package cools sealed and pressurized electronic equipment. The fan circulates air through the liquid cooled heat exchanger and over electronic components in a hermetically sealed module. Air cooled units are also available. Fan and heat exchanger are designed, built and packaged by AiResearch for matched performance. Package size is tailored to your individual cooling requirements.

The Garrett Corporation, through its AiResearch Manufacturing divisions, is an industry leader in components and cooling systems for aircraft, missiles and nuclear applications. This wide experience is now being offered to the electronics industry to provide a cooling package to meet any cooling requirement. Send us details of your problem or contact the nearest Airsupply or Aero Engineering office for further information.

THE GARRETT CORPORATION

AiResearch Manufacturing Divisions

Los Angeles 45, California • Phoenix, Arizona

AERO ENGINEERING OFFICES:

MINEOLA • ATLANTA • BALTIMORE • BOSTON • CHICAGO • CINCINNATI • COLUMBUS
DETROIT • INDIANAPOLIS • PHILADELPHIA • ST. LOUIS • SYRACUSE • WINTER PARK

AIRSUPPLY OFFICES:

BEVERLY HILLS • DENVER • FT. WORTH • KANSAS CITY • SAN DIEGO • SAN FRANCISCO
SEATTLE • TULSA • WICHITA

Precision



Deflection **YOKES** and Systems

We now supply yokes to the largest laboratories and defence projects in the U. S. A. Available to customers specs. in Nickel Iron, Ferrite, Class A or H insulation. Moulded-in slip rings can be supplied.

Linearity - standard $\pm 1\%$, custom build to $\pm .1\%$.

Orthogonality $\pm 1/4^\circ$.

Half-axis colinearity $\pm 1/2^\circ$.

Mutual interaxis coupling .0025 or as specified by customer.

Differential capacity unbalance - 3.5 uuf max.

High Altitude Performance is limited only by flashover point of the terminals, which can be specified by customer.

Temperature Range -

Standard deflection yokes will operate as specified from -10°C to $+60^\circ\text{C}$.

Class H insulated deflection yokes will operate from -50°C to $+160^\circ\text{C}$.

Humidity: The yoke is unaffected by humidity.

Meet JAN and MIL Specs.

For further information write:

COSSOR

(CANADA) LIMITED
301 Windsor Street
Halifax, Nova Scotia
Phone 4-6487

Circle 116 Readers Service Card

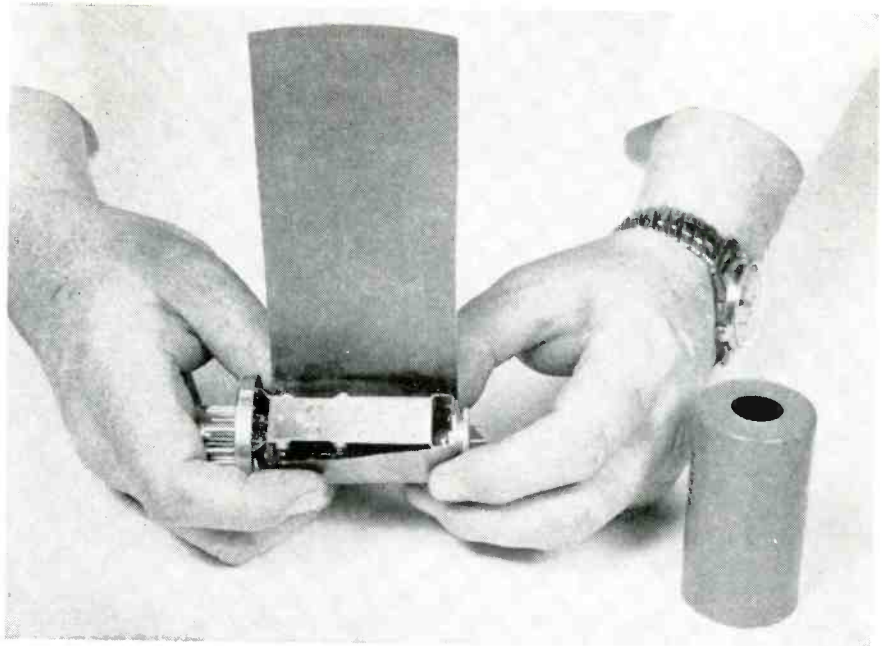

Wrapping relay with flexible magnetic shielding foil, thin enough to fit inside regular housing of relay

over a wide frequency range. Two wrappings provide ample shielding without leakage at joints.

Miniaturization is facilitated because the thin foil does not appreciably increase the bulk of the component. A tube wrapped in the foil will still fit in its standard shield even with the 0.007-in. foil, which is the thickest now made. The other standard thickness is 0.004 in. The material is available from the Magnetic Shield Division of Perfection Mica Co. as Netic and Co-Netic foils in rolls of various widths and lengths. It wraps tightly like a tape and does not spring back because annealing leaves it soft. Attenuation ranges

from 8 to 1 at 60 cps to 1,200 to 1 at 250 mc.

► **Applications**—The foils can be advantageously used in a host of laboratory, electronic, electrical, airborne and shielded room applications. These include all types of experimental shielding for laboratory testing, transformer chokes, cable wrapping, lining the inside of vibrator and relay cans, vacuum-tube shielding, and lining the inside of wood or aluminum cabinets for ham or hi-fi uses.

An unusual application is using the foil as wallpaper to shield an entire room. The material can be applied by any carpenter, paper

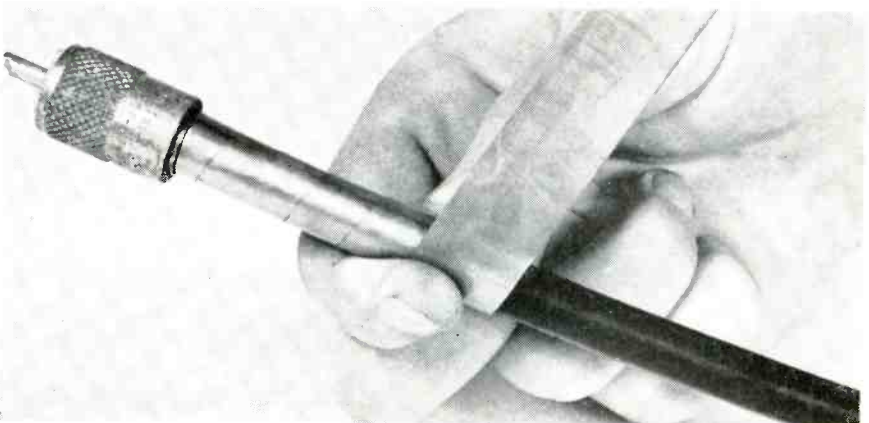

Wrapping cable spirally with foil. Sufficient overlap to give two layers of foil is recommended to prevent hum pickup

PROVE IT YOURSELF!

ULTRA-HIGH POLYSTYRENE PRECISION CAPACITORS

as low as 0.1% tolerances in most values!

Leading engineers know that S. E. C. pioneered the current polystyrene capacitors in Guided Missiles and Analog Computers. S. E. C. test data and engineering experience is based on years of research and constant improvement of product.

S. E. C. products have proved the answer to many tough engineering problems by such leading *analog computer manufacturers* as; Electronic Associates, Reeves Instrument, Beckman Instrument, Mid-Century Instrument, Goodyear Aircraft, Donner Scientific, Boeing Airplane Company and such *military contractors* as Northrop Aircraft, Gilfillan Brothers, North American Aviation, Convair, Motorola, Farnsworth Electronics, Bendix Aviation, Federal Tele-Communications and many others.

R. & D. establishments as M.I.T., Jet Propulsion Labs, Cornell Aeronautical Labs, Battelle Memorial Inst., Sandia Corp., and many others have chosen S. E. C. engineered components for their prototypes.

Check these outstanding features for yourself:

- Tolerances as close as 0.1%
- Insulation Resistance as HIGH as 1×10^{12}
- Dielectric Absorption as LOW as .0001
- Dissipation Factor as LOW as .0002
- Temperature Coefficient...100PPM per °C.
- Stability as close as .05% drift in 1 yr.
- Voltage derating . . . none to 170° F.
- *Hermetically sealed for enduring accuracy!*

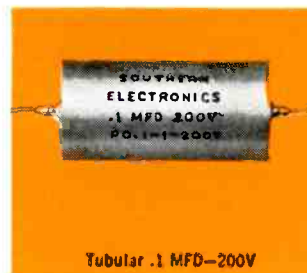

For your most exacting requirements—always specify S. E. C.

**SOUTHERN
ELECTRONICS**
Corporation



150 West Cypress Ave.
Burbank, California

PIONEERS IN CUSTOM PRECISION CAPACITOR ENGINEERING

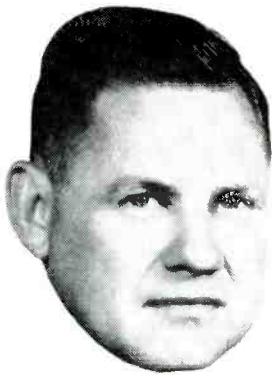

J. A. RYDER, President
Ryder System, Inc.

"We of Great Southern Trucking Company are constantly aware of Jacksonville's importance as a distribution and financial center," says Mr. Ryder. "In 24 years Great Southern has grown into the Southeast's largest motor common carrier. Our faith in the city's future is reflected in our new half-million dollar general office and modern new terminal through which pass 11 million pounds of freight each week."

Jacksonville FLORIDA

Strategic Transportation and Distribution Center Gets Great New Truck Terminal

GREAT SOUTHERN TRUCKING COMPANY, the Southeast's largest motor carrier and part of the Ryder System, Inc., serving 24 states, has erected a \$500,000 truck terminal and general office in Jacksonville, because a Jacksonville location best serves the Southeast's rapidly expanding business and industry.

GREAT SOUTHERN'S new terminal is indicative of Jacksonville's importance as an industrial and distribution center serving a radius of 400 miles overnight.

Jacksonville has much to offer you, too, whether your need is for industrial, warehouse, branch plant or southeastern office locations.

Jacksonville has excellent year-round climate, air, rail, highway and water transportation, ample electricity and industrial water, plenty of manpower, good schools and cultural facilities. Complete plant site files available.

Look into Jacksonville today. Send for "THE JACKSONVILLE STORY", a condensed, factual outline of Jacksonville's advantages. Or ask for a confidential survey tailored to your problems.

Ideal Every Day for Work and Play

The CITY OF JACKSONVILLE, Florida
Electric and Water Utilities

THE COMMITTEE OF ONE HUNDRED,
Jacksonville Area Chamber of Commerce
604-E Hogan Street Phone: ELgin 3-6161
Circle 117 Readers Service Card

PRODUCTION TECHNIQUES

(continued)

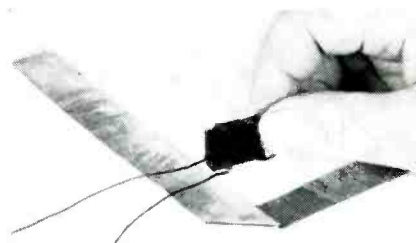

First step in shielding miniature audio transformer. Strip of foil is cut from sheet with ordinary scissors and folded at angle as shown

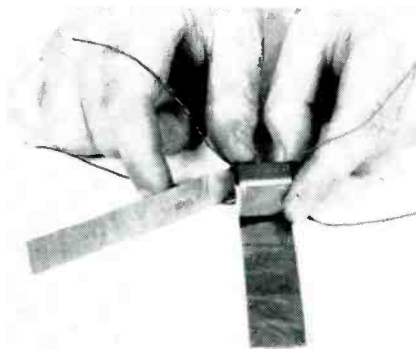

Wrapping with single strip of foil in manner shown, to get two layers on each side, leaves no gaps for flux leakage

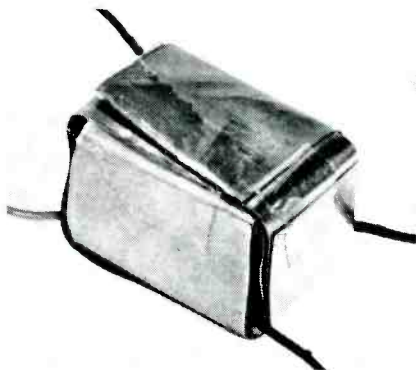

End of wrapping can be anchored with small piece of Scotch tape. Shield can be grounded conventionally, but this is usually not necessary

hanger or electronic technician in a matter of hours, using only scissors, hammer and small nails. With wide overlap construction, no welding, soldering or brazing is required. If desired, a pleasing finish may be added by painting. The foil wallpaper eliminates the expense and problems of bringing an unwieldy conventional shielded room into a hospital, laboratory or other location where space and access are limited.

► **Medical Uses**—Hospital bed enclosure shields as well as electro-

encephalographic rooms may be constructed by first placing foil layers between flooring materials or directly beneath the entire bed. The rest of the shield should be fabricated with a hinged end or side so it can be slid around the bed when needed. Shielding is not affected by the outer or inner materials. The inner material should then be padded for soundproofing or patient protection and the outer layer finished in a material that harmonizes with the appearance of other hospital equipment. Air conditioning or air replacement may be provided if the enclosure is to be used for long periods of time.

► **Airborne Uses**—The light weight makes the foils particularly suitable for airborne applications. These include band wrappers for magnetic valves, cable wrapping, power supply shielding, servo motor wraps and insert liners for vibrator and relay cans.

► **Audio Uses**—The flexibility is a

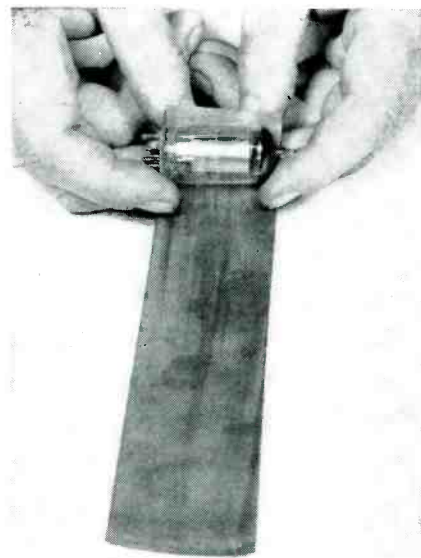

Method of wrapping vacuum tube in Co-Netic foil to prevent hum pickup

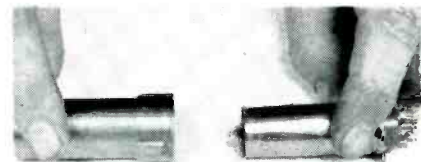

Wrapped tube slips easily into standard aluminum shield can, since foil is thin and dead-soft

these four applications
are improved with

DAPON[®] resin



APPLIANCE HANDLES to match any color décor of the modern kitchen are now possible. The exceptional heat stability of DAPON resin molding compounds (producible in a wide range of colors) permits the finished article to withstand high temperature exposure for prolonged periods of time with substantially no loss or change in color. Moldability of DAPON resin compounds is excellent. Added advantages of good impact strength, high detergent resistance, unmatched resistance to food and beverage staining make DAPON the number one resin for appliance handles.

DAPON resin is a solid prepolymer of diallyl phthalate; making available the outstanding properties of this material in a form readily usable in all types of thermosetting resin operations.

In selected applications these properties are unmatched by existing resins. DAPON resin should be evaluated for use as the base resin in any thermosetting application requiring chemical resistance, heat and humidity resistance, superior electrical properties, good moldability, or dimensional stability.

Extensive testing programs have been completed to point up those uses and applications in which DAPON resin has distinct merit and produces decidedly better properties.

Molding compounds with various fillers, reinforcing fibers and colors are now available. Government approval under a number of military specifications has been obtained.

Let us know the application you have in mind for DAPON resin . . . write now for literature and technical data.

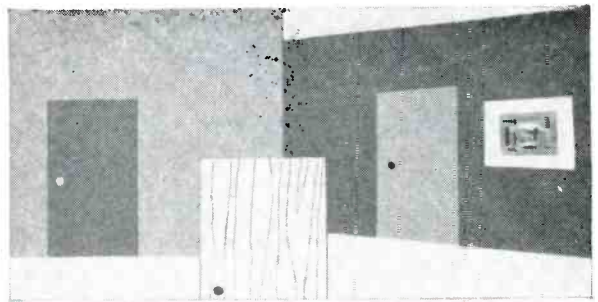

DECORATIVE LAMINATES made with DAPON resin do not require the usual "facing" steps. The printed paper can be laminated directly to the backing material in a single operation. For applications requiring soft backing materials excellent flows can be effected at pressures as low as 50 psi. With either high or low pressures, laminates of DAPON resin exhibit exceptional resistance to abrasion, chemicals and heat.

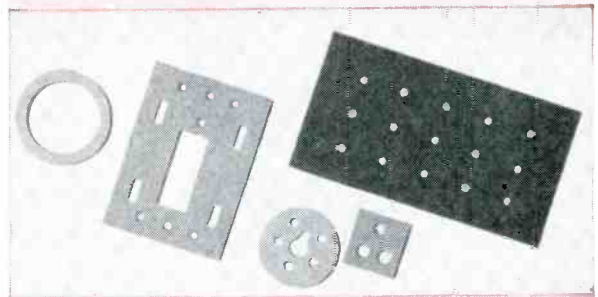

INDUSTRIAL LAMINATES made with DAPON resin have a number of outstanding properties: Superior electrical properties e.g., high insulation resistance retained under conditions of high humidity; heat resistance without degradation even under sustained vibrational stress. Other advantages exist in end uses requiring a high degree of chemical and moisture resistance, good dimensional stability, mechanical strength and ease of machinability. Formulated with or without volatile solvents DAPON resin is suitable for use in the full range of pressure curing conditions.

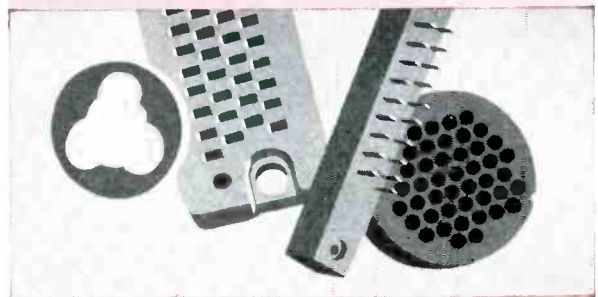

MOLDED ELECTRICAL PARTS containing DAPON resin exhibit highest resistance to humidity changes. Maximum retention and rapid recovery of electrical properties are insured by the unmatched stability of DAPON resin and the absence of deleterious products of degradation under long term use conditions. Properties of dielectric strength, dielectric loss, volume resistivity and arc resistance are particularly outstanding. Very low molding and post molding shrinkage allow close tolerances and the use of closely spaced inserts. Moldability and resistance to heat and chemicals are excellent.

fmc[®]

FMC Organic Chemicals Division

Food Machinery and Chemical Corporation

O H I O — A P E X

161 East 42nd Street • New York 17, N. Y.

fmc
FOOD MACHINERY
AND CHEMICAL
CORPORATION



chemicals

OTHER FMC CHEMICAL DIVISIONS: WESTVACO CHLOR-ALKALI Alkalis, Chlorinated Chemicals, Carbon Bisulfide
WESTVACO MINERAL PRODUCTS Phosphates, Barium and Magnesium Chemicals • BCCO CHEMICAL Peroxygen
Chemicals • NIAGARA CHEMICAL Insecticides, Fungicides and Industrial Sulphur • FAIRFIELD CHEMICAL Pesticide Compounds

TEFLON*

SHEET....ROD....

TUBING....MOLDED OR MACHINED PARTS?

YOU CAN GET JUST WHAT YOU WANT



from
JOHN CRANE



"Made of Teflon by JOHN CRANE" has become practically a standard specification for parts and components subject to severe electrical, corrosive, thermal, mechanical or atmospheric abuse. Whatever your requirements in Teflon . . . sheet, rod, tubing, packings, gaskets, bellows, insulators, sealing discs or non-stick parts . . . "John Crane" can supply them!

In addition, you get these important *plus* factors: complete uniformity throughout, high density control, freedom from flaws and rigid adherence to your specifications.

"John Crane's" complete fabrication facilities assure you prompt delivery on *exactly* what you want — no compromise. If you have an entirely new requirement, no standard design or procedure — "John Crane's" laboratory facilities, know how, research and engineering experience go to work on *your particular need*.

Now is a good time to put "John Crane" to test. Contact Crane Packing Company today.

* **TEFLON** DuPont trademark

Advantages:

- CHEMICAL**— Completely inert
- ELECTRICAL**—Extremely low power factor
Very high dielectric strength
- THERMAL**—Temperature range
—300°F. to +500°F.
- MECHANICAL**— Strong, flexible
Weather resistant
- LOWEST COEFFICIENT OF FRICTION**
- ABSOLUTELY NON-STICK**

CRANE PACKING CO.
6402 Oakton St.,
Morton Grove, Ill.
(Chicago Suburb)

In Canada:
Crane Packing Co., Ltd.,
Hamilton, Ontario.



valuable factor in providing greater hi-fi fidelity. Applications here include lining high impedance input transformer cans, spiral wrapping around input lead from pickup head to preamplifier, wrapping pickup arm and head liner, use as disk between friction plate and turntable, use as subpanel under turntable between amplifier and pickup head, use as tube wrappers inside normal tube shields at input stages, and separating tuners, amplifiers and pre-amplifiers when these units are placed on top of each other.

3-D Packaging for Transistorized Circuits

By JOHN A. WEREB, JR.
Staff Member, Lincoln Laboratory
Massachusetts Institute of Technology
Lexington, Mass.

PARALLEL MOUNTING of axial-lead components in a three-dimensional package has been applied to transistorized logic circuitry to reduce size and weight, improve ventilation potentialities, insure adequate mechanical strength and speed construction.

One method of using this construction employs discardable solder-in modules, while the other permits replacement of any part. Conventional axial-lead components which meet military specifications are used throughout both methods.

The solder-in module is constructed so it can be discarded in case of failure of resistors or capacitors. Semiconductors, which are more costly, are mounted near the perimeter of the module for easy replacement or salvage. This method avoids plug and connector failure; however, the modules are more difficult to remove and require a modified element in the soldering iron.

The second method makes use of

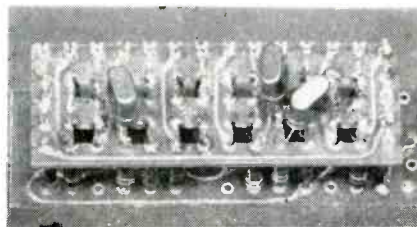

Cross-shaped holes in etched wiring boards permit replacing any of four components through each large hole

JOHN CRANE **CRANE PACKING COMPANY** 30 YEARS INDUSTRIAL PROGRESS
OFFICES IN ALL PRINCIPAL CITIES

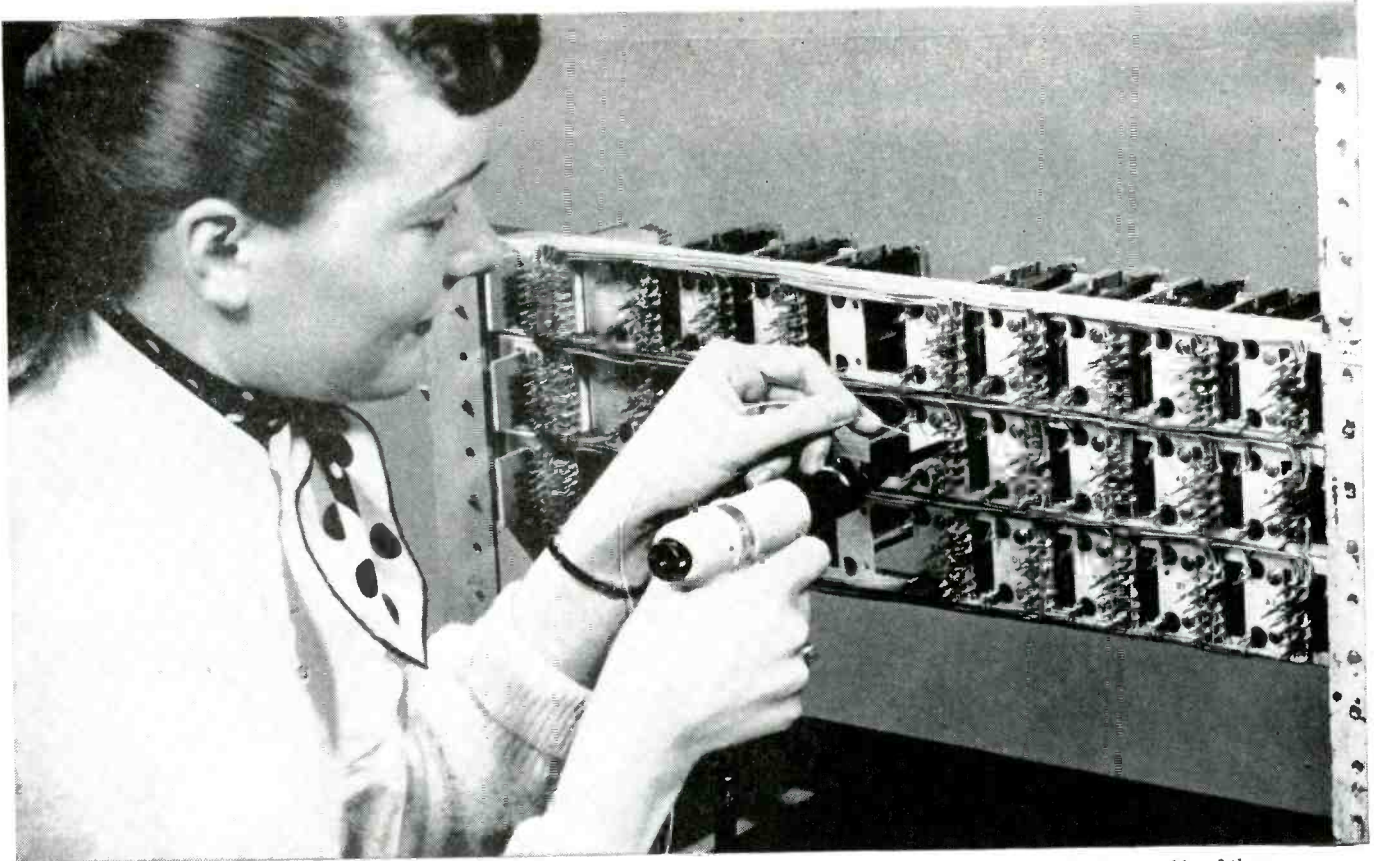

Keller "Wire-Wrap" tools play an important part in assembly of these well-known products: TV sets, computers, electric motors, radios.

Why solderless connections with Keller *Wire-Wrap*® Tools are fast . . . reliable

Keller "Wire-Wrap" tool is fast operating—only seconds per connection. It automatically wraps wire around terminals to make solderless, permanent connections. No additional operations required. Tool weighs just one pound . . . no operator fatigue to slow down production schedules.

There are no faulty connections requiring expensive hand repair work. To date, well

over 700 million connections have been made with "Wire-Wrap" tools without a reject. The exclusive controlled-tension compresses wire into terminal to assure permanent metal-to-metal contact. Either air or electric models.

Possibly you can step up production with "Wire-Wrap" tools while reducing assembly costs. Consult with your Gardner-Denver Industrial Specialist.

2.7 to 3 seconds to make a connection

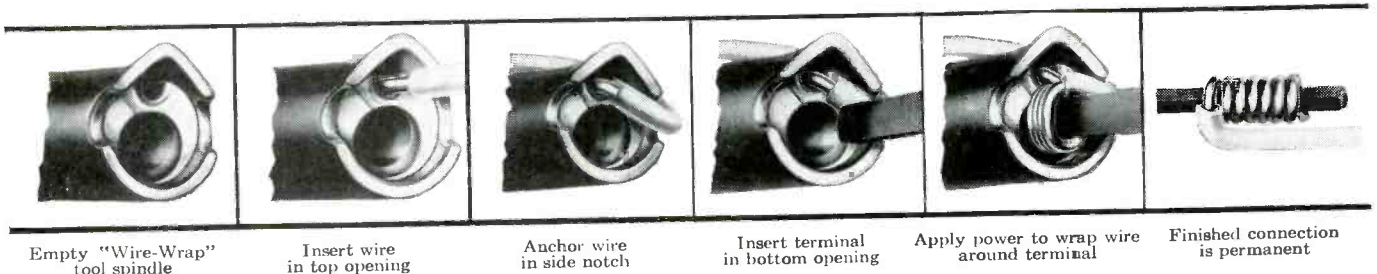

Empty "Wire-Wrap" tool spindle

Insert wire in top opening

Anchor wire in side notch

Insert terminal in bottom opening

Apply power to wrap wire around terminal

Finished connection is permanent



ENGINEERING FORESIGHT—PROVED ON THE JOB
IN GENERAL INDUSTRY, CONSTRUCTION, PETROLEUM AND MINING

GARDNER - DENVER

Gardner-Denver Company, Quincy, Illinois

Capable Transistor Transformer design is simple as

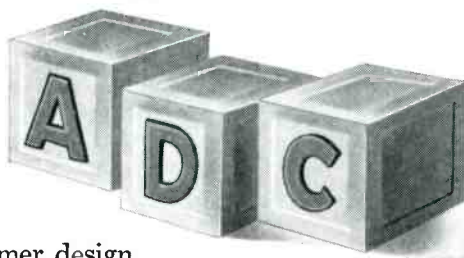

Capable transistor transformer design is simple at ADC. The problems are no different than those for vacuum tube circuits. And ADC has been solving these design problems for 22 years.

The transformer shown below at right, was ADC designed as an experimental output transformer for use by Minneapolis Honeywell with their H200E Power Tetrode. This transformer is capable of delivering up to 20 watts with low distortion through the frequency range of 20 to 20,000 cycles. A typical application is pictured below in the class A amplifier circuit.

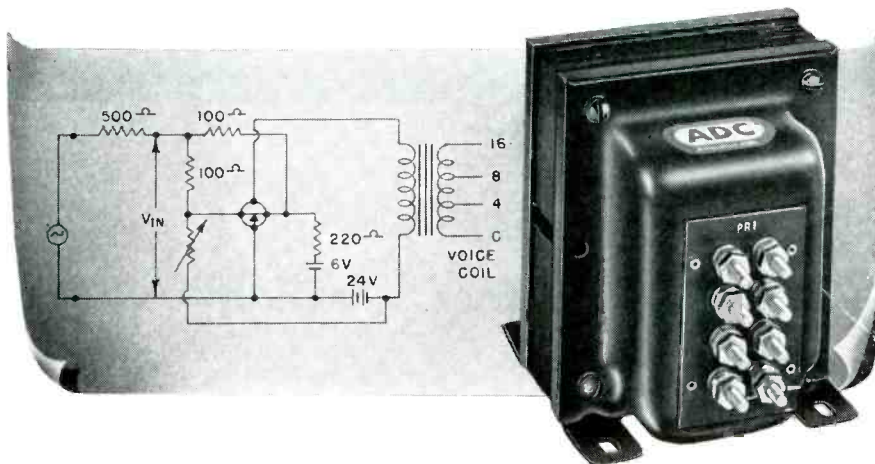

The tiny transistor transformers such as those illustrated at the right are for low power applications. Introduction of new, low distortion, power transistors has required larger transformers, especially for operation at low frequency. While these may be new to transistor circuits, the design problems and solutions are identical with those of vacuum tube circuitry.

Whether you are interested in transformers for use with transistors or vacuum tubes, it will be to your advantage to come to a firm with the design experience of a pioneer like ADC.

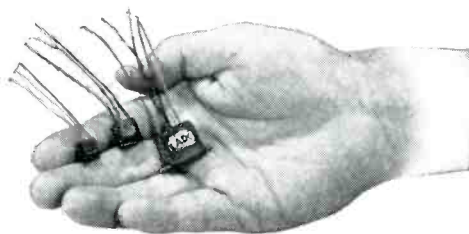

Write for the **NEW** ADC CATALOG

AUDIO DEVELOPMENT COMPANY
 2838 13th AVENUE SOUTH • MINNEAPOLIS 7, MINNESOTA
 TRANSFORMERS • REACTORS • FILTERS • JACKS & PLUGS • JACK PANELS

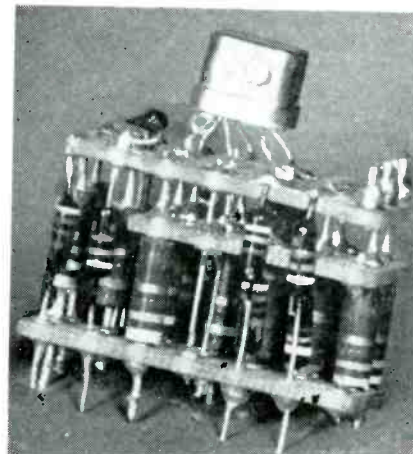

Module built up from three wafers to give three-dimensional packaging

cross-shaped holes in the mounting board to permit removal of small internal components. Any of four components can be replaced through each hole. Both techniques have been employed in the repackaging of a transistorized airborne transducer.

► **Construction** — Printed circuit boards are prepared by standard methods using hand construction for small quantities. Eyelets are used throughout and double-sided wiring is used as necessary.

Individual component leads are precut and cleaned for reliable soldering. No bent leads are used. A printed board is then selected and an aluminum comb is put in place, followed by an aluminum nest. The components are dropped into the nest and soldered in place. The comb adjusts the spacing of components from the board and helps conduct heat from the unit during construction.

After the first soldering operation, the nest and comb are removed and the comb is placed on the other end. The second board is then soldered and the comb is removed.

For those units with a third board the last operation is repeated. Little trouble has been encountered with remelting of the connections when the third board is being soldered since the soldering time is short and the comb removes some heat.

The modules are soldered into an interconnecting base board which contains power and interconnecting leads. In this particular experi-



**new AMP wire splice team
cuts costs in
aircraft and
electronic industries.**

One-piece construction and precision tooling cuts application time to absolute minimum while guaranteeing perfect, permanent mechanical and electrical connections.

Three and one-half years of engineering research have developed the following features:

Color Coding of both connector and tooling

... assures correct matched selection of wire, splice and tooling

Rectangular center window

... assures positive wire depth in barrel

Inspection ports on ends

... assures definite braid enclosure



AMP

AMP INCORPORATED
General Offices:
3310 Eisenhower Blvd.
Harrisburg, Pa.

*A-MP of Canada, Ltd., Toronto, Canada • A-MP-Holland N.V., 's-Herlogenbosch, Holland
Aircraft-Marine Products (G.B.) Ltd., London, England • Societe A-MP de France, Courbevoie, Seine, France
Oriental Terminal Products Co., Ltd., Tokyo, Japan*

BOURNS

TRIMPOT®

and related sub-miniature potentiometers
-thousands of variations
available from stock

SELECT from the many combinations shown below. Any choice is available in a wide selection of standard resistance values... for military or commercial applications.

these TERMINALS:



WIRE LEADS

SOLDER LUGS

PRINTED
CIRCUIT PINS

in these TYPES:

(select one or any combination)

HIGH OR MEDIUM TEMPERATURE	HUMIDITY PROOF	HIGH RESISTANCE	DUAL OUTPUT	VARIABLE RESISTOR
----------------------------------	-------------------	--------------------	----------------	----------------------

with these RESISTANCE ELEMENTS:

WIREWOUND



CARBON



ALL UNITS FEATURE sub-miniature size... space-saving configuration... self-locking shaft with 25-turn screwdriver adjustment... excellent acceleration, vibration and shock characteristics... mounting individually or in stacked assemblies, with standard 2-56 screws.

Over 50,000 units in stock. Send for complete catalog on the TRIMPOT and related potentiometers.

PLUS THE NEW TRIMPOT JR.



Micro-miniature size $\frac{3}{16}$ "x $\frac{3}{16}$ "x1"
 2.0-watt power rating. Humidity proof.
 175°C. max. operating temperature.

CORP. BL. PATENTS ISSUED AND PENDING



BOURNS LABORATORIES, INC.

General Offices: 6135 Magnolia Ave., Riverside, Calif.
 Plants: Riverside, California—Ames, Iowa

TRIMPOT • LINEAR MOTION POTENTIOMETERS • PRESSURE TRANSDUCERS AND ACCELEROMETERS

PRODUCTION TECHNIQUES

(continued)

mental unit some coupling capacitors were not of the axial type and were conveniently mounted on the outside of the modules.

► **Troubleshooting**—Sufficient voltage points are externally accessible to instrument probes so that a defective component can be located. The module is then removed from the baseboard with the modified iron and a new one inserted. The defective module can either be repaired or discarded. If a transistor fails it can be replaced without re-

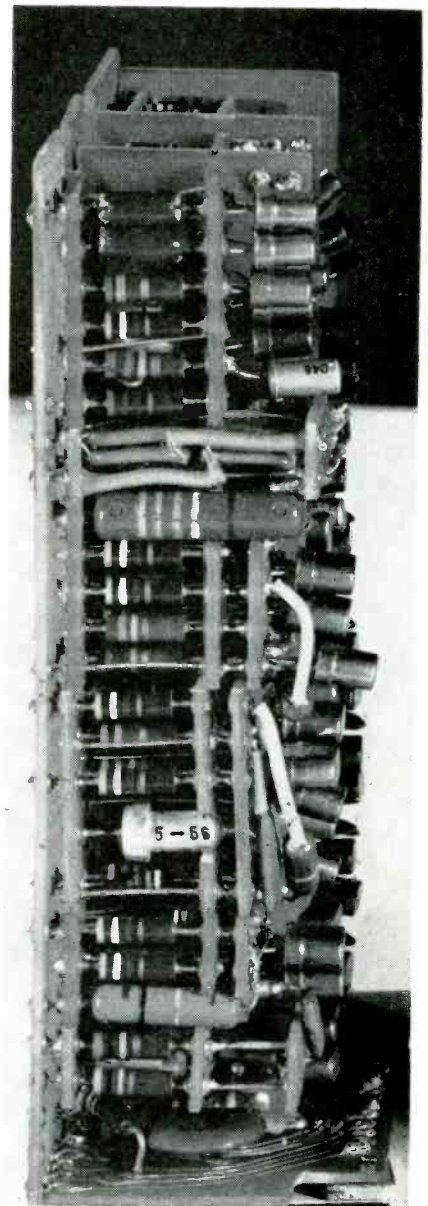

New computer logic package occupies one-fourth the volume of former conventional design yet contains practically all the parts that were in old unit

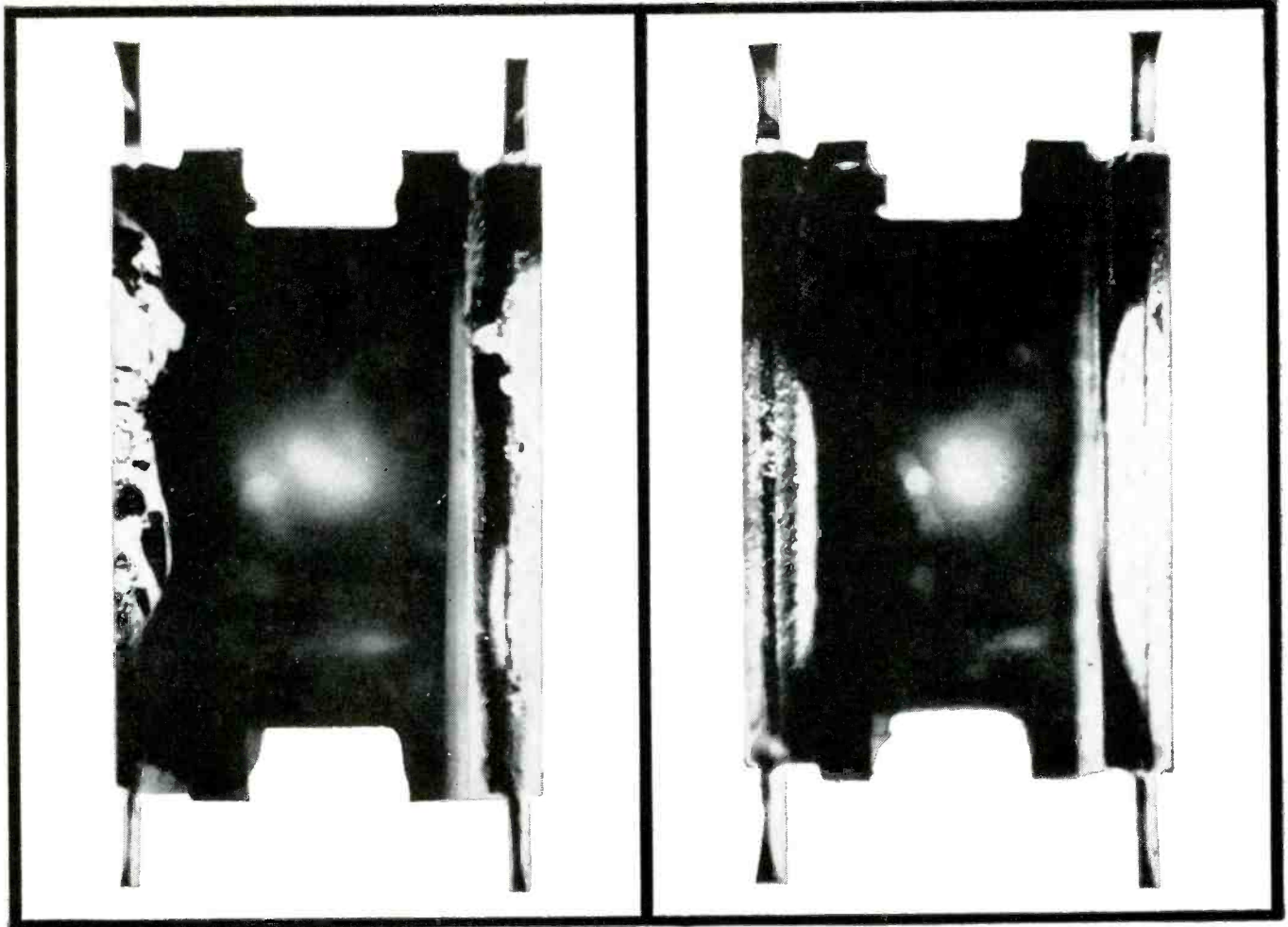

Now you can make perfect welds in coated, greasy, carbonized, oxidized or highly conductive metals!

Surface-contaminated metals do *not* have to be cleaned before welding! Raytheon's Heat Program Timer gives you strong, consistent, high-quality welds regardless of the surface condition of the metals to be joined. Highly conductive metals can also be perfectly welded with ease.

A typical application is the carbonized tube anode shown above. The left-hand photo illustrates how conventional welding causes splashes and a weak joint. The strong, clean weld (right) is produced with the Heat Program Timer. Because perfect welds such as this can be made without pre-cleaning of parts, savings in time and money result.

Greater freedom of design, material selection, coating and structure, and high-speed, low-cost production welding are assured with this unit.

Raytheon manufactures a complete line of precision welding systems. To learn how this equipment can solve your small parts metal-joining problems, or to have your samples processed in Raytheon's Welding Application Laboratory, please write Dept. 6120.

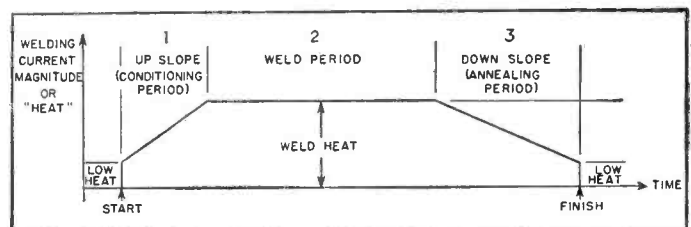

PROGRAMMED WELDING CYCLE

1. Heat build-up "conditions" the metal surfaces by burning through the coating—eliminates splatter.
2. Precisely controlled constant heat welds the metals.
3. Decreasing heat anneals the weld—reduces brittleness. Each period is independently adjustable from 2 to 10 cycles. Weld heat can be varied from 20%-100% of maximum; low heat, 0-80% of weld heat.



Heat Program
Timer

Excellence in
Electronics



RAYTHEON MANUFACTURING COMPANY

Commercial Equipment Division, Waltham 54, Massachusetts

A-2200

MICRO-BEARING ABSTRACTS

by A. N. DANIELS, President
New Hampshire Ball Bearings, Inc.

MEASUREMENT OF RADIAL RUNOUT

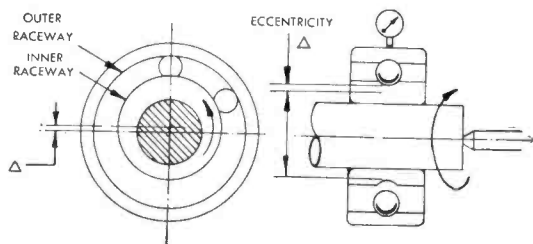

Fig. 1 — Measuring eccentricity of bore with respect to inner raceway.

Occasionally questions are raised about the methods of measuring "radial runout" and "out-of-round". In order to define "radial runout" properly, a discussion of "eccentricity" and "out-of-round" is necessary.

The amount of out-of-round, or lack of roundness of a given part (inner or outer ring or ball) is the difference between the maximum and the minimum diameter of the part in question.

Eccentricity refers to the distance between the centers of two circles. Concentricity refers to the exact coincidence of the centers of two or more circles. In high grade instrument bearings there is a very small tolerance on the permissible eccentricity between the bore and the inner ring raceway, and likewise between the outside diameter and the outer ring raceway.

Inner raceway out-of-round is measured by forcing the ring between the rounded edges of two discs, one of which is fixed and the other of which is mounted on the indicating mechanism. The difference between the maximum and minimum readings reveals the amount of out-of-round. Out-of-round of the outer ring raceway is measured by placing the ring over two rounded points which engage the raceway. One point is fixed and the other actuates an indicating mechanism. As the ring is rotated, the difference between the maximum and minimum readings indicates the degree of out-of-round.

The true amount of eccentricity between the bore and the inner ring raceway can be measured, providing these circles are not out-of-round, by mounting the assembled bearing on a slightly tapered arbor, applying a calibrated indicator on the center of the stationary outer ring, and then slowly rotating the arbor. The eccentricity is the difference between the minimum and maximum gage reading as the arbor is

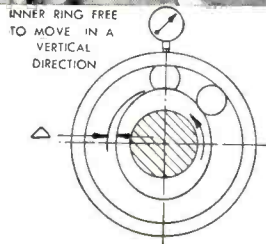

Fig. 2 — Inner raceway is out-of-round, although concentric with bore.

rotated through one revolution. Similarly, the eccentricity of the outer ring is measured by the difference in the dial readings with the arbor and inner ring held stationary while the outer ring is rotated one revolution. Fig. 1 shows the set-up with an inner raceway which is eccentric with respect to the bore.

In the case above it has been stipulated that the bore and inner raceway must not be out-of-round, for only under these conditions is the true eccentricity measured.

If the raceway is out-of-round, while being either eccentric or concentric with respect to the bore, the out-of-round will be transmitted to the indicator, thereby influencing the reading. A condition in which the inner raceway is out-of-round although concentric is shown in Fig. 2.

In view of the fact that the majority of bearing rings will unavoidably be somewhat out-of-round and eccentric, however slightly, it is obvious that the measurement described above indicates neither true eccentricity nor true out-of-round but a summation of the two quantities. Hence, the measurement is more correctly termed radial runout.

DESIGN HANDBOOK OFFERED FREE

If you work with miniature bearings, you'll find this new, 70-page authoritative publication contains a further discussion of radial runout and is a great help in solving problems in designing instruments or small electro-mechanical assemblies.

It will be sent free to engineers, draftsmen and purchasing agents. Write to: New Hampshire Ball Bearings, Inc., Peterborough 1, N.H.



moving the module since it is mounted externally.

► **Applications**—This technique has been used in an experimental unit in which the ability to replace components was important. The model

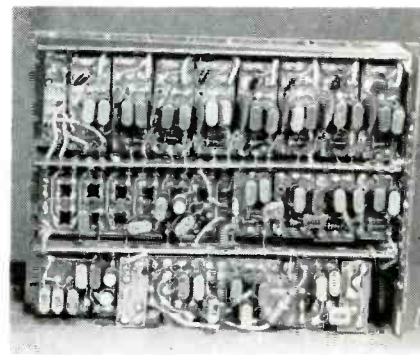

Top view of new three-dimensional package, showing how wiring boards at right angles provide interconnections for modules

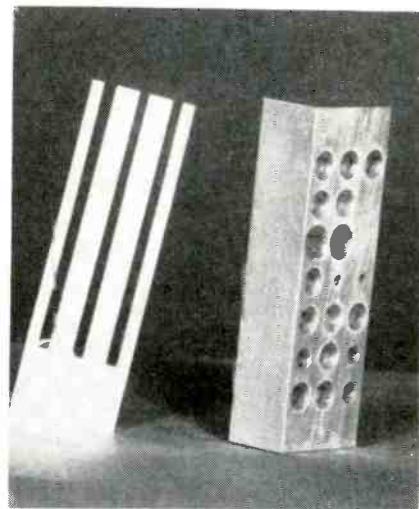

Aluminum comb and nest used in assembling modules

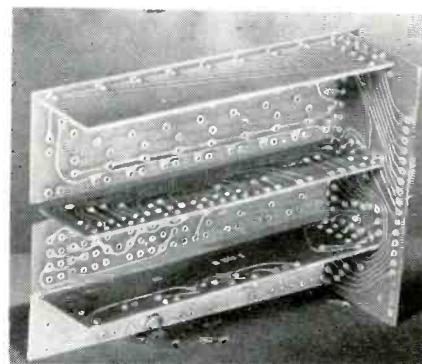

Method of providing interconnections between boards and modules. Power and logic inputs are on vertical row of eyelets at right



HSD

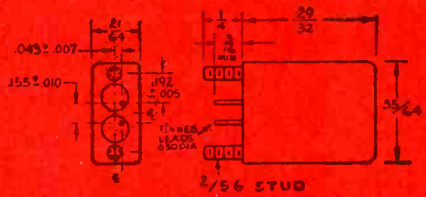

HSB

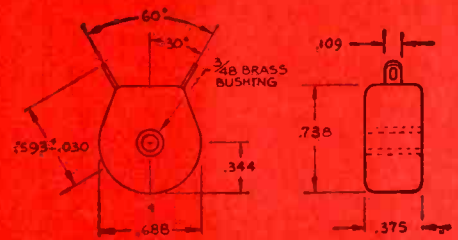

MPF

THREE STANDARD PACKAGES AVAILABLE IN THREE CORE TYPES

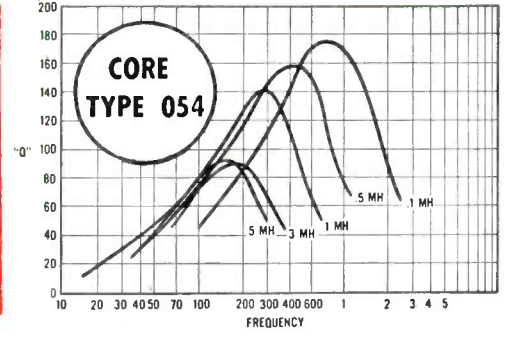
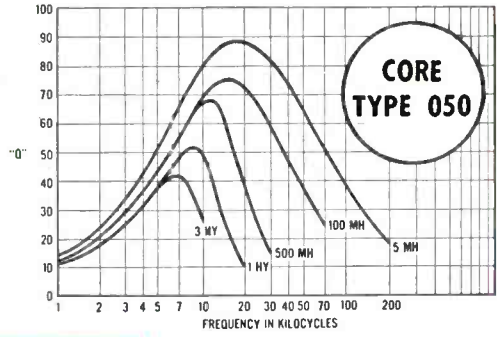
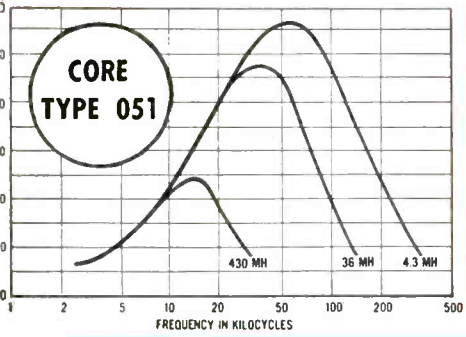

MOLDED and CASED TOROIDS

STANDARD INDUCTANCE VALUES:			
Dash No.	050	051	054
-1	5.0 MH	1.0 MH	.05 MH
-2	6.0	1.2	.06
-3	7.2	1.5	.072
-4	8.6	1.75	.086
-5	10.0	2.0	.100
-6	12.0	2.4	.120
-7	15.0	3.0	.150
-8	17.5	3.6	.175
-9	20.0	4.3	.200
-10	24.0	5.0	.240
-11	30.	6.0	.300
-12	36	7.2	.360
-13	43	8.6	.430
-14	50	10.0	.500
-15	60	12.0	.600
-16	72	15.0	.720
-17	86	17.5	.860
-18	100	20.0	1.0
-19	120	24.0	1.2
-20	150	30.0	1.5
-21	175	36.0	1.75
-22	200	43.0	2.0
-23	240	50.0	2.4
-24	300	60.0	3.0
-25	360	72.0	3.6
-26	430	86.0	4.3
-27	500	100	5.0
-28	600	120	6.0
-29	720	150	7.20
-30	860	175	8.6
-31	1.0 HY	200	10.0
-32	1.2	240	
-33	1.5	300	
-34	1.75	360	
-35	2.0	430	
-36	2.4	500	
-37	3.0		

IN ORDERING: Please designate type, core, dash number, and inductance value. For example: "MPF 050 -10 24 MH."

SUBMINIATURE TOROIDS

unlimited!

HSD-HSB and MPF SERIES NOW STOCKED FOR SAME DAY SHIPMENT

The country's largest facilities for the production of toroidal components now makes possible the maintaining of warehouse stocks and immediate delivery of CAC's popular subminiature toroids—in a wide range of inductances.

This is CAC's answer to heavy industry-wide demand. Elaborate testing and inspection procedures assure both quality and required performance.

Our "Heart of America" location minimizes transit time to all parts of the U. S.



World's Largest Exclusive Producer of Toroidal Windings

COMMUNICATION ACCESSORIES COMPANY
 Lee's Summit, Missouri • Phone Kansas City BRoadway 1-1700
 A Subsidiary of Collins Radio Company

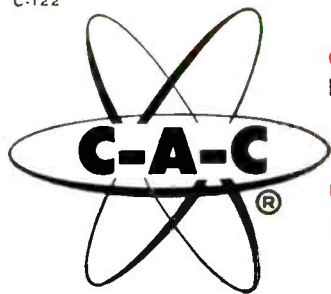

- AUTOTUNES
- FERRITE CORES
- HEAT DISSIPATING TUBE SHIELDS
- MAGNETIC AMPLIFIERS
- MISSILE POWER TRANSFORMERS
- MECHANICAL FILTERS

- UNCASED TOROIDS
- PLASTIC CASED TOROIDS
- HERMETICALLY SEALED CASED TOROIDS
- SUBMINIATURE TOROIDS
- PERMEABILITY-TUNED VFO'S

- SEALED MISSILE POWER SUPPLIES
- LAMINATED TRANSFORMERS AND INDUCTORS
- PRECISION RATIO COMPUTER TRANSFORMERS
- L-C FILTERS

New twist in testing ...a torsional exciter

TORSIONAL testing has been done with rectilinear motion shakers by applying ingenuity in linking table to specimen. But here's a new MB exciter that produces torque *directly*. Its performance characteristics permit you to use it as a *calibrator* for torsional pickups and accelerometers . . . as well as for testing gyros and relays (as examples), or checking torsional vibrations of armatures, or determining torsional modes in various rotating parts.

OPERATING FACTS

At free-table, no load, this MB Model CA 1050 Exciter oscillates at up to 1600 cps without resonance in moving elements. It develops 110 ft. lbs torque, which produces angular accelerations as high as 1570 radians/

sec/sec. Maximum total displacement is 45°.

A MATCHED SYSTEM

Any one of several MB electronic power supplies drives the equipment, depending on the specific frequency range, power, and performance you want. The MB Model T51 Power Supply shown comes with automatic cycling controls if desired.

SEND FOR DETAILS

Technical data available. And for more information on how and where to use this unusual equipment, contact our staff of vibration specialists. You can't come to a better qualified authority on the subject . . . nor to one more willing to help on your specific vibration testing problems.



manufacturing company

A DIVISION OF TEXTRON INC.

1075 State Street, New Haven 11, Conn.

HEADQUARTERS FOR PRODUCTS TO ISOLATE . . . EXCITE . . . AND MEASURE VIBRATION

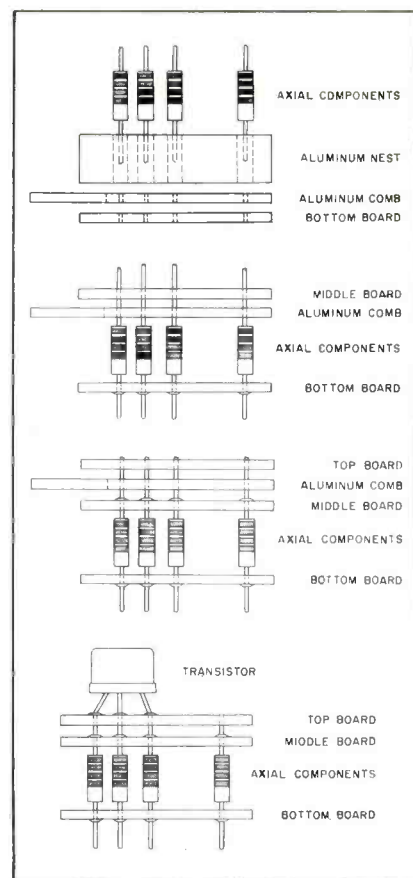
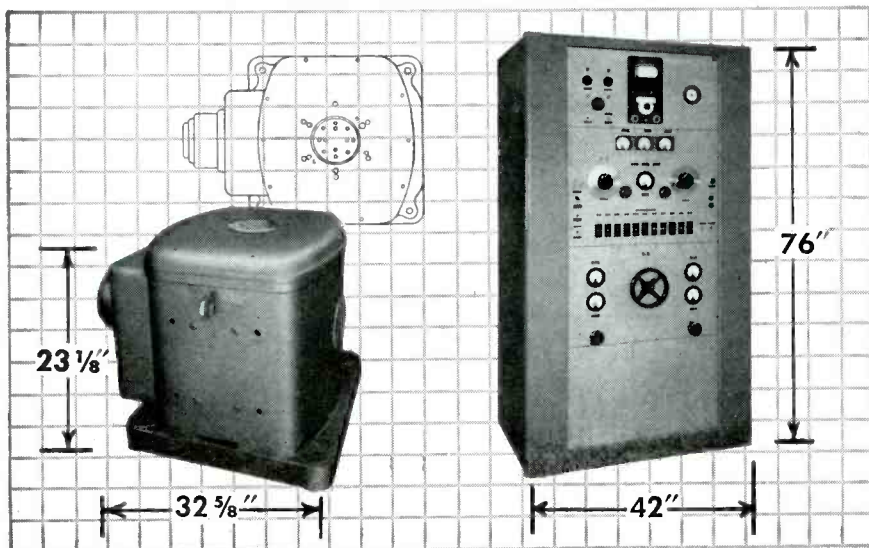

Steps in assembling module

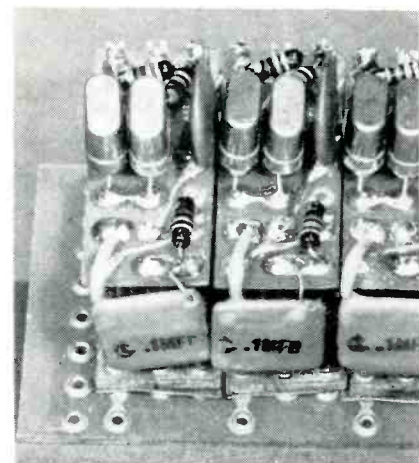

External mounting of capacitors

has been flown in interceptor aircraft for 20 hours without failure, although not subjected to military test specifications. It has also been used successfully in ground mock-ups for better than 20 hours.

The technique should prove useful for units having low power dissipation and therefore permitting high-density packaging, providing there are no periodically replaced

MEASURE MICROVOLTS

without pre-amplification!



\$580.

with
the New
Du Mont
type



FEATURING

AMPLIFIERS: Direct coupled amplifiers with single-ended or balanced input.

EXTREME SENSITIVITY: 5 millivolt to 500 volts full scale, continuously variable. Additional sensitivity for short term measurements, with resolution down to 20 microvolts.

FREQUENCY RANGE: DC to 300 KC.

Y AMPLIFIER CALIBRATION: 5%.

SWEEPS: 19 calibrated linear sweeps, 0.5 sec/cm to 0.5 usec/cm. Calibrating accuracy, 5%.

EXPANDED SWEEP: Any 10 cm portion of 50 cm sweep may be expanded 4 times and positioned on screen.

Price **\$580⁰⁰**
Slightly higher in 50 cycle areas

TYPE 403R Rack mounted version, electrically identical to Type 403 \$595.00

Complete Details On Request...



DU MONT

TECHNICAL SALES DEPARTMENT,
Allen B. Du Mont Laboratories, Inc., Clifton, N. J.

The Type 403 is the most sensitive oscilloscope commercially available. It permits direct measurements from low output transducers such as strain gages, pressure pickups, accelerometers, and others that normally require pre-amplifiers.

When used as a direct reading voltmeter, the Type 403 offers stability of better than 1 millivolt per hour for all ranges from 500 volts all the way down to 1 millivolt full scale. A super sensitive range is available of 1 millivolt full scale (100 microvolts per scale division) for short term measurements.

This outstanding performance is wrapped in the nicest package in the industry. The 403 features "human engineering" resulting in easier operation, complete accessibility and unsurpassed reliability backed by a 5-year guarantee.

Ballantine

SENSITIVE ELECTRONIC VOLTMETER

Battery Operated



MODEL 302C—Price \$245.

VOLTAGE RANGE:

100 microvolts to 1000 volts rms of a sine wave in 7 decade ranges.

INPUT IMPEDANCE:

2 megohms shunted by 10 mmfd on high ranges and 25 mmfd on low ranges.

FREQUENCY RANGE:

2 cps to 150,000 cps.

ACCURACY:

3% except 5% below 5 cps and above 100,000 cps and for any point on meter scale.



- Available accessories increase the voltage range from 20 microvolts to 10,000 volts.
- Available precision shunt resistors permit the measurement of AC currents from 10 amperes down to one-tenth of a microampere.
- Features the well-known Ballantine logarithmic voltage and uniform DB scales.
- Battery life over 100 hours.
- Can also be used as a flat pre-amplifier with a maximum gain of 60 DB. Because of the complete absence of AC hum, the amplifier section will be found extremely useful for improving the sensitivity of oscilloscopes.

For further information on this and other Ballantine instruments write for our new catalog.

BALLANTINE LABORATORIES, INC.

100 Fanny Road, Boonton, New Jersey



PRODUCTION TECHNIQUES

(continued)

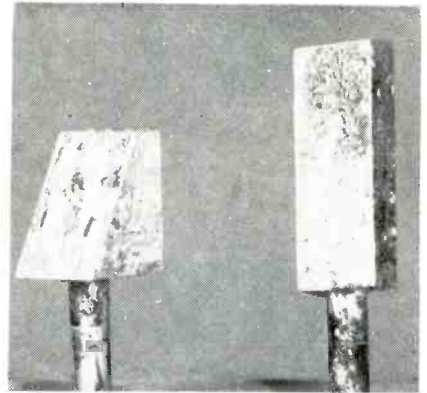

Two types of soldering iron heads used for removing defective module from base-board. Both plug into standard 130-watt iron taking 1/4-inch round shaft

parts such as vacuum tubes, relays or other special short-life components in the circuits.

The research on this packaging technique was supported jointly by the Army, Navy and Air Force under contract with the Massachusetts Institute of Technology.

Nylon-Insert Screws Replace Locking Cement

SWITCHING TO nylon-insert self-locking screws and nuts eliminated a messy job and saved assembly time on mounting bases for airborne electronic equipment at the Hawthorne, N. J. plant of T. R. Finn & Co. The base protects a delicate electronic anti-skid device in the nose-wheel well of jet fighters.

Because flush-mounting pro-

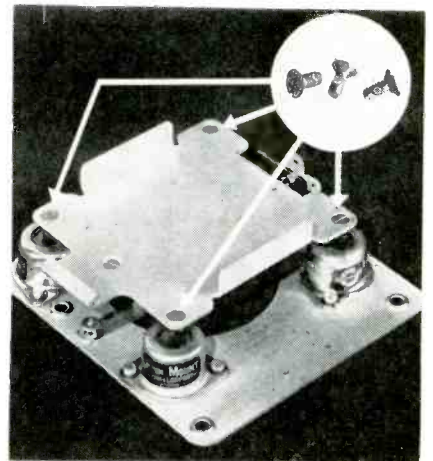

Arrows point to locations of new self-locking screws which fasten platform to studs of vibration mounts. Similar Nylok nuts secure bonding straps

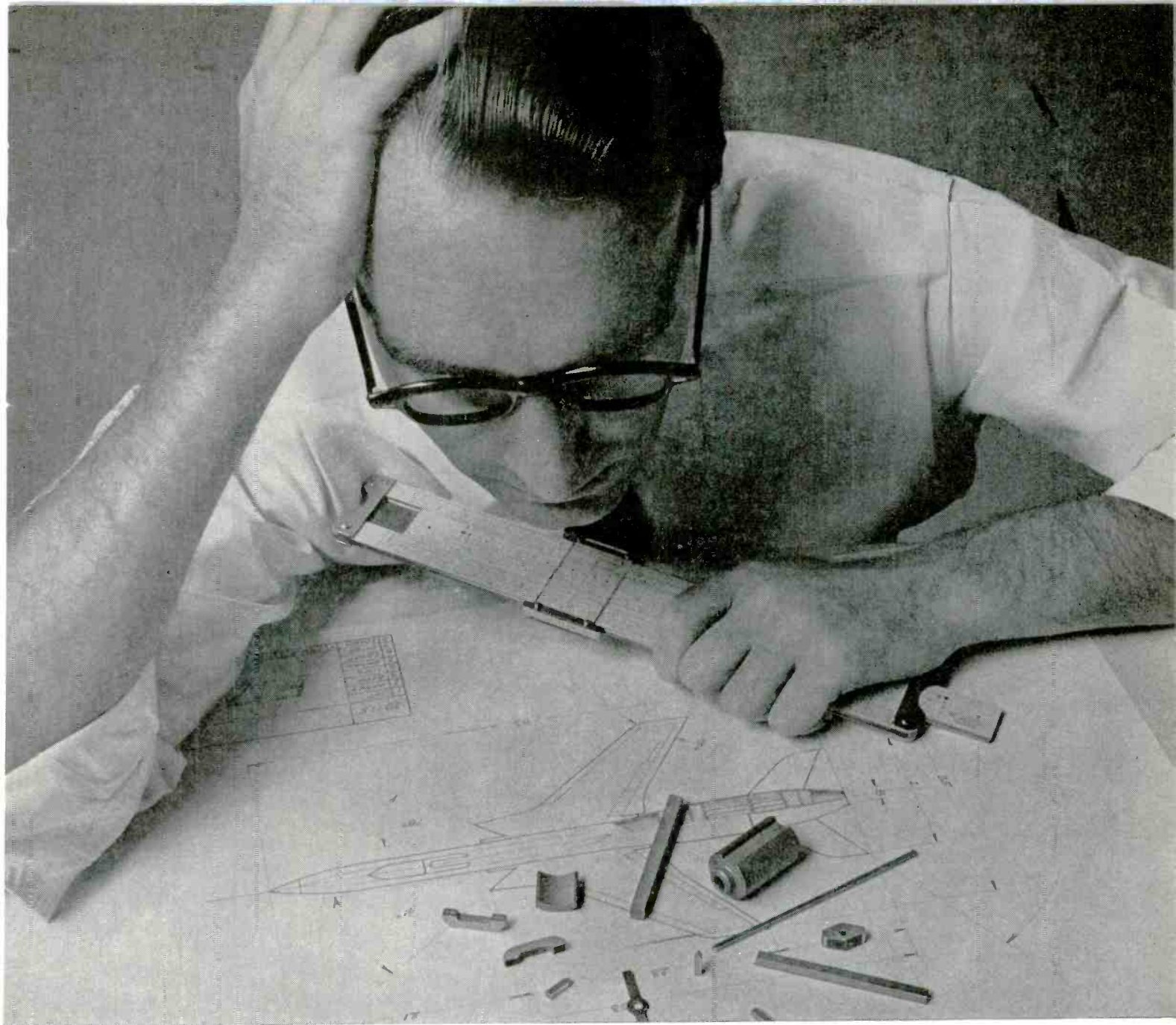

Can a 30% increase in magnet energy simplify your design problem?

It probably can if you're faced with the tight space problems involved in today's control and navigation instrumentation, communication, auxiliary power and radar equipment designs.

Only Crucible investment-cast Alnico permanent magnets offer the higher energy you need — 30% more than sintered magnets, for example, size for size. Crucible increases the energy product even further by adding fractional

amounts of silicon and zirconium to the magnet composition. These additions also help provide a fine surface finish that is free of gas pockets and other discontinuities. This uniform surface makes grinding easier and faster.

Why not take advantage of Crucible's facilities and experience in this specialized field? A Crucible magnet engineer can work on your problem now. Just call the Crucible office nearest you.

Crucible, the only producer of higher energy investment-cast Alnico permanent magnets, also offers you sand-cast and shell-molded magnets in any shape, tolerance and finish needed. Sizes range from a fraction of an ounce to several hundred pounds.

General Sales Offices, The Oliver Building, Mellon Square, Pittsburgh 22, Pa. Branch Offices and Warehouses: Atlanta • Baltimore • Boston • Buffalo • Charlotte • Chicago • Cincinnati • Cleveland • Dallas • Dayton • Denver • Detroit • Grand Rapids • Harrison • Houston • Indianapolis • Los Angeles • Milwaukee • New Haven • New York • Philadelphia • Pittsburgh • Portland, Ore. • Providence • Rockford • San Francisco • Seattle • Springfield, Mass. • St. Louis • St. Paul • Syracuse • Toronto, Ont.

CRUCIBLE

first name in special purpose steels

Crucible Steel Company of America

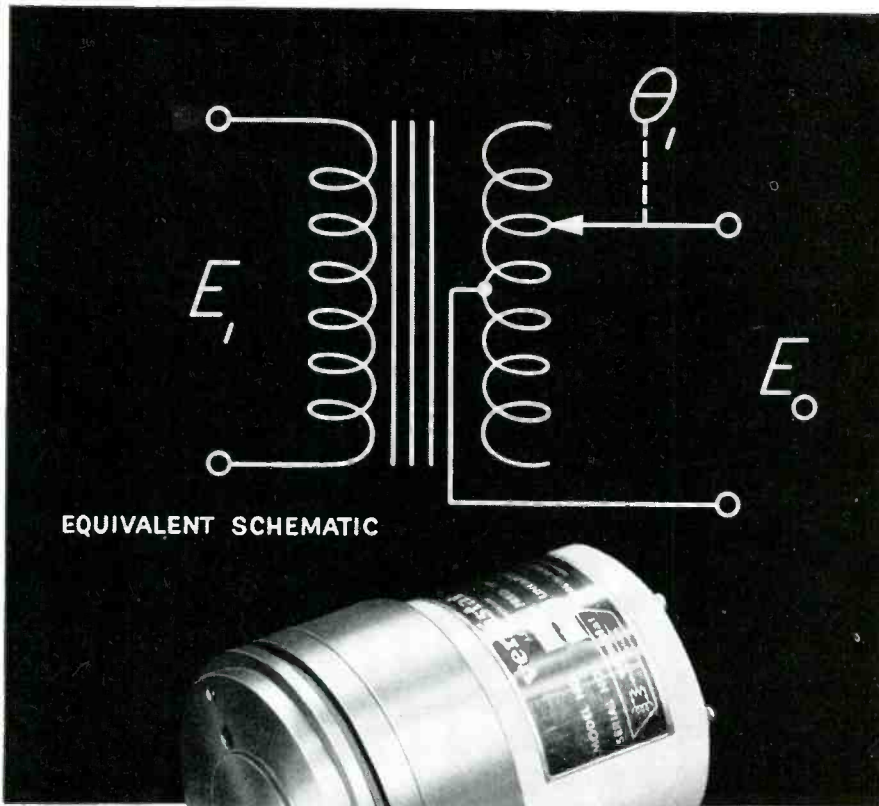

A NEW HIGH RESOLUTION **vernistat**[®] COMPUTING TRANSFORMER

The Vernistat Model 20C is a new type of variable ratio computing transformer that provides unusually high basic resolution and linearity. By means of a unique switching mechanism 800 discrete values of output are obtained. A resistive interpolating brush further subdivides these voltages to provide almost infinite resolution. The Model 20C's high linearity results from the accurate placement of secondary turns on the transformer. Linearity is maintained under full load by the transformer's low output impedance.

A shaft rotation of 3,600 degrees covers the full range of output voltage. The transformer provides several watts of output power which eliminates power amplifiers in many applications. This output is isolated from the primary allowing for the summation of several transformer voltages. Output is with respect to the center tap and provides for phase inversion. Phase shift is kept at a minimum.

Typical applications of the transformer are the direct supply of power to torque motors for gyro erection, operation of servo motors, and in analog computers where the products of voltages and shaft angles are required.

Diameter	2.0"
Length	2.5"
Shaft rotation	3,600 degrees
Linearity, unloaded	±0.1%
Linearity, with 1,000-ohm load connected	±0.35%
Rated output	80 ma
Basic resolution	0.13%
Input voltage	115 volts at 400 cps
Output voltage, isolated	±80 volts at 400 cps
Quadrature	5 mV per unit of input

vernistat[®]

division

PERKIN-ELMER CORPORATION
Norwalk, Connecticut

hibits the use of lockwashers, plain countersunk-head screws previously used had to be hand-dipped in a plastic locking cement to lock them in the mounting stud. The operation was time-consuming and costly, almost always a messy job and often marred the finish. The changeover to self-locking screws and nuts made by The Nylok Corp., 611 Industrial Ave., Paramus, N. J., has resulted in faster and neater assembly with better protection to the mount and the electronic equipment it was designed to hold.

The Nylok self-locking screw holds its exact position and provides a positive lock because a nylon pellet inserted into the threads of the screw shank bears against the threads in the mount stud. This produces a tight metal-to-metal fit between mating threads and prevents the screw from loosening or changing position.

Because nylon is an elastic material it tends to regain its original shape. The screws and nuts can thus be reused many times without losing their self-locking ability.

Choosing Materials for Heat-Resistant Radomes

By HUGH O. PIERSON
*Canopy and Laminate Dept.
Goodyear Aircraft Corp.
Akron, Ohio*

HEAT resistance is a major factor in the choice of materials for both solid-wall and sandwich radomes of supersonic aircraft and missiles. Structurally, solid-wall radomes are more homogeneous and have better strength at high temperatures, but the weight penalty

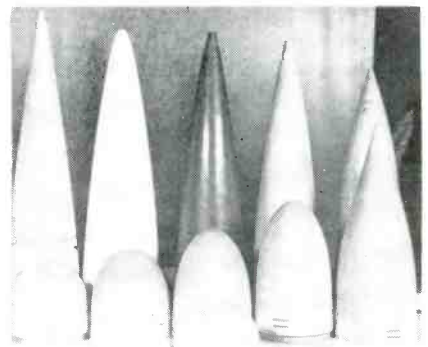

Examples of missile radomes

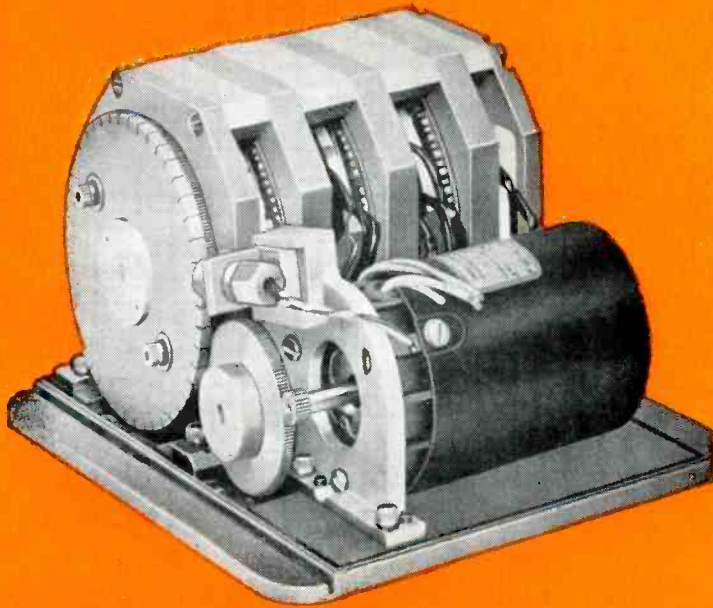

MYCALEX TM Commutation Switch for Telemetry, Using Precision-molded SUPRAMICA* 555 ceramoplastic Commutator Plates. MYCALEX ELECTRONICS CORPORATION Under Exclusive License of MYCALEX CORPORATION OF AMERICA



Precision-molded SUPRAMICA* 555 ceramoplastic Commutator Plate, CP-346, with 360 Contacts and 2 Slip Rings. Other Standard Plates are Available.

RELIABILITY DOES NOT COST EXTRA

MYCALEX* TM commutation switches set new standards of reliability for aircraft and missile telemetry

\$25,000 a minute is costly time — but that is the estimated value of the final "count-down" for a major missile test.

Telemetered information will record the vital history of the flight and point the way to new developments and advancements. To achieve complete control, absolute dependability and long life, precision equipment is essential, both during flight and during the "count-down" when a complete check-out is demanded. Cleaning and adjusting commutators during the final hours or minutes of "count-down" is expensive — and wasteful.

MYCALEX* TM commutation switches with precision molded commutator plates of SUPRAMICA 555 ceramoplastic introduce new standards of reliability to this important operation. Hundreds of hours of completely unserviced life with dependable, low-noise-level signals is definitely attainable. Customer

evaluation tests have shown satisfactory operation of MYCALEX TM switches for over 1000 hours at 1200 RPM with only brush cleaning and routine maintenance.

These exceptional performance standards are possible because of painstaking precision assembly and testing, and the use of SUPRAMICA ceramoplastic commutator plates, which have total, permanent dimensional stability and will withstand temperatures as high as 500 degrees C. without distortion or contact loosening.

MYCALEX TM commutation switches and SUPRAMICA ceramoplastics are making significant contributions to the reliability and durability of electronic equipment for military and civilian applications.

Write for detailed information.

*MYCALEX and SUPRAMICA are registered trade-marks of Mycalex Corporation of America. 555 is a trade-mark of Mycalex Corporation of America.

MYCALEX
CORPORATION OF AMERICA



EXECUTIVE OFFICES:
30 ROCKEFELLER PLAZA
NEW YORK 20, NEW YORK

GENERAL OFFICES AND PLANT:
CLIFTON, NEW JERSEY

CHICAGO - LOS ANGELES - DAYTON
WASHINGTON - MIAMI

Mission Accomplished . . .



with an FM Telemetry Transmitter

There's not much left of a missile or its components after it slams back into the earth with a force of many thousand g's. Since it's vitally important to know what happens during a test flight, inflight data must be remotely collected by telemetry.

The Radiation, Inc. Telemetering Transmitter is designed to ride these missiles and transmit information back to the ground station during the flight. It is built to operate reliably in the extreme environments (100g shock, 2000 cps vibration, -55 to +75°C) encountered by the missile. Its small size, light weight and rugged construction make this transmitter the best available for such applications.



Spurious Rejection	—	60db below carrier
Frequency Stability	—	0.01%
Frequency Range	—	215-235 mc
Power Output	—	2 watts
Weight	—	1.7 pounds

Write P. O. Box 37, Melbourne, Florida for complete specifications.

Personnel
Inquiries
Invited



**RADIATION
INC.**

MELBOURNE AND ORLANDO, FLORIDA
ELECTRONICS • AVIONICS • INSTRUMENTATION

of solid-wall radomes is so great that sandwich structures are considered wherever possible. Sandwich radomes, on the other hand, introduce such problems as different expansion rate and bond between the skins and core.

Solid-wall structures formerly showed better transmission and boresight deflection, but recent developments with loaded-core radomes permit the manufacture of sandwich structures which are elec-

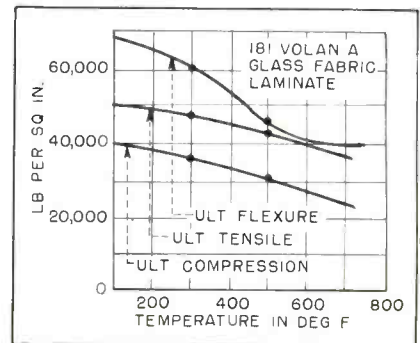

Strength of phenolic laminate

trically uniform at high temperatures while still giving the strength-weight advantages of sandwiches.

Designers of missile radomes may take advantage of the inherent poor heat resistance of organic laminates. Surface decomposition of the radome provides an insulating barrier to slow down the progression of heat through the rest of the laminates. Thus, materials which are far from attaining the heat resistance theoretically needed may still be used if this principle of controlled destruction is followed.

Each radome presents a specific material problem related to its specific function. Choice of the optimum material requires a thorough knowledge of available materials, including their behavior at elevated temperatures and their structural and electrical characteristics. To aid in making this selection, the eligible types of materials are here compared from a standpoint of usefulness for supersonic radome construction.

The thermosetting resins used in laminates, being organic, are built around a carbon element. Such a

How the Queen's picture would keep its charm

Introducing "FAXTAPE"—facsimile on magnetic tape

We were entirely in accord with the British and Canadian points of view. Her Majesty's plans to visit Canada deserved special effort . . . which meant, from us, an earlier-than-planned unveiling of magnetic-tape facsimile recording.

In anticipation of phone-line news photos of the occasion, Ampex delivered FAXTAPE num-

ber one to Canadian Overseas Telecommunication Corporation's Vancouver office. By recording pictures off the wire onto tape, C.O.T.C. can retransmit to overseas with no visible loss of quality—desirable for any subject—most fitting preparation for the Queen.

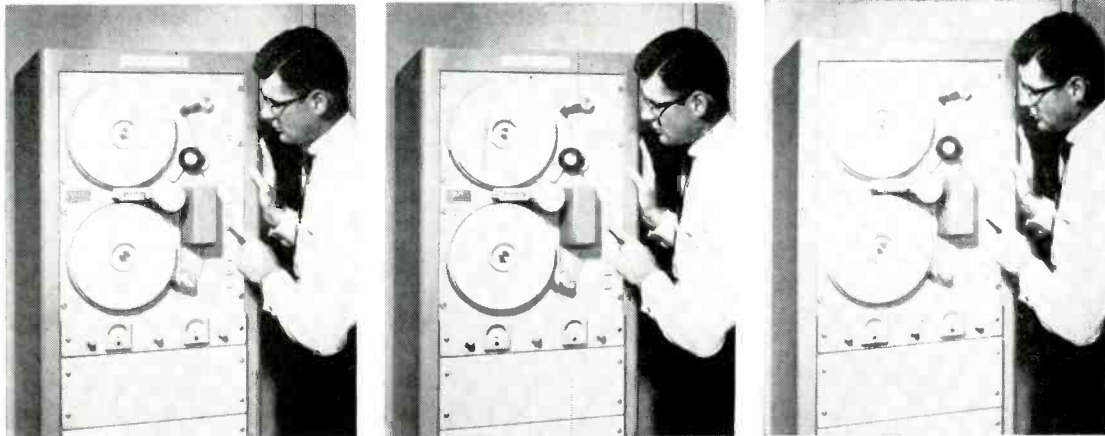

FAXTAPE records its own photograph and provides a revealing comparison. Left photo was printed directly off the facsimile wire. Center is the photo after being received on tape and retransmitted. Right is the same photograph after being retransmitted the conventional way off a facsimile print.

A SLOW-SCAN COUSIN OF VIDEOTAPE

Ampex's FAXTAPE is to facsimile as Videotape is to television. It records the electrical signals used in picture transmission. Tape playback reproduces identical voltage patterns, retransmitting the picture and/or feeding a transceiver to make a negative or print.

FAXTAPE is a versatile adaptation of an Ampex FR-1100 instrumentation tape recorder. FM-carrier electronics provide faithful amplitude reproduction for accurate grey-scale with a tape speed of 7½ in./sec. matching phone-line frequency response of 2500 cycles/sec. A real technical achievement in the system is a tough, reliable time standard so precise that the drift is only one second per week. This keeps picture skew down to imperceptible levels.

PICTURE TRICKS AND PRACTICAL ANSWERS

For news photos, weather maps, documents and military data, picture quality no longer demands simultaneous transmission to all receiving points. From tape a second-generation facsimile is as good as the original. Even a third or fourth tape generation is entirely acceptable.

For unattended receiving, FAXTAPE provides one whole hour of recording time per reel. Unlike a facsimile transceiver, magnetic tape does not require make-ready on each picture—and incidentally eliminates chance of wrong scanning speed or photo development errors. Voice instructions, coding and scale are recorded on the tape together with the picture itself.

Lines and radio links can be used more effectively and economically with FAXTAPE. Facsimile can be collected on tape and held for available line time or clear broadcast conditions. Also, when wider frequency bands are available, the tape can be speeded up many fold reducing transmission time accordingly.

Tricks? FAXTAPE plays back an electronic picture. You can stretch it, shrink it, speed it up, slow it down, invert the grey scale, juggle the values, or feed it all to a computer—subject only to the limits of human ingenuity. Any ideas?

Can we send you a brochure? answer questions on a specific application? or mail more of this informative ad series direct? For any of these requests, please write Dept. E-9.

MAGNETIC
TAPE
APPLICATIONS
BY AMPEX

ONE OF A SERIES

9



Series FR-100



Series 800 Mobile
and Airborne



Model FR-200
Digital



Series FL-100
Loop Recorders



Series FR-1100

INSTRUMENTATION
DIVISION

AMPEX
CORPORATION

FIRST IN MAGNETIC TAPE INSTRUMENTATION

934 CHARTER STREET · REDWOOD CITY, CALIFORNIA

District offices serving all areas of the United States and Canada; Foreign Representatives in countries around the world.

Excellent
stability
characterizes
this new
vacuum tube
voltmeter
by RCA



RCA VACUUM TUBE
VOLTMETER
Type LV-10
Also ask about Null Voltmeters.

THIS VACUUM TUBE VOLTMETER is extremely versatile, combining in one instrument an AC Voltmeter—covering a range from audio to UHF frequencies, a DC Voltmeter—with 100 megohms input resistance, and an ohmmeter capable of measuring resistance from zero to 1000 megohms. Ideal for use wherever highly precise measurements are essential. Maximum stability and low current consumption are outstanding features. Balanced indicating movement makes this exceptional instrument suitable for use lying flat, standing vertically or inclined.

For complete information on the above and other instruments in the RCA line, write to RCA, Dept. Z-46, Building 15-1, Camden, N.J.

- DC VOLTS
- 7 ranges: 1, 3, 10, 30, 100, 300, 1,000.
- Accuracy: $\pm 3\%$ full scale deflection.
- Input resistance: 100 megohms $\pm 2\%$ on all ranges.
- AC VOLTS
- 6 ranges: 1, 3, 10, 30, 100, 300.
- Sine Wave Accuracy: $\pm 3\%$ full scale deflection.
- Input impedance: Less than 2 mmf in parallel with 15 megohms.
- Frequency Response: ± 1.0 db, 18 cps to 700 MC.
- Relative Measurements: possible to 1,000 MC.
- RESISTANCE: 0 to 1,000 megohms in 7 ranges.
- Accuracy: $\pm 5\%$ between divisions 10 and 100 on scale.
- DB Range: -10 to $+52$ dbm in 6 ranges.
- Zero dbm = 1 mw in 600 ohms.



Tmk(s) ®

RADIO CORPORATION
OF AMERICA

COMMERCIAL ELECTRONIC PRODUCTS
CAMDEN, N. J.

In Canada: RCA VICTOR Company Ltd., Montreal

Instrument
Engineering
Representatives in
Principal Cities

carbon element means relatively poor heat resistance, although chemists may rearrange the molecules to reach 1,000F or slightly more for limited periods. Above that temperature, organics must be abandoned at present in favor of the jungle of inorganics.

► **Modified Polyesters**—The heat resistance of modified polyesters is sufficient for most aircraft now in service. With proper post-cure, they retain good structural properties up to 360F. Electrically they are very good. Fabrication is easy. Bag molding can readily be used particularly for producing large shapes and prototypes of any size.

Above 360F the strength of modified polyesters drops off rapidly and they are of little value above 400F.

► **Triallyl Cyanurate**—The TAC resins possess excellent strength retention up to 500F. Electrical properties also are relatively good (dielectric constant 4.3, loss tangent 0.019 for 181 cloth laminates at 9,360 mc). The major disadvantage is a violent polymerization reaction, accompanied by much shrinkage and crazing. Blistering is difficult to avoid and fabrication tricky. Other disadvantages are lengthy post-cure and poor interlaminar strength. Wet-layup bag molding techniques may be successfully employed with careful processing. Keeping these limitations in mind, satisfactory radomes can be made. Several large programs have been completed using a considerable volume of TAC resins.

► **Epoxies**—One large airframe manufacturer uses epoxies almost exclusively in producing radomes. Their heat resistance, a notoriously weak point, has been substantially improved with the appearance of new curing agents such as hexanhydride or dicyandiamide. Excellent strength retention is shown with a recently developed epoxy even after 200 hours at 500F. These new developments, however, are still in the experimental stage. Because of their exceptionally high strength and outstanding interlaminar strength, epoxies should

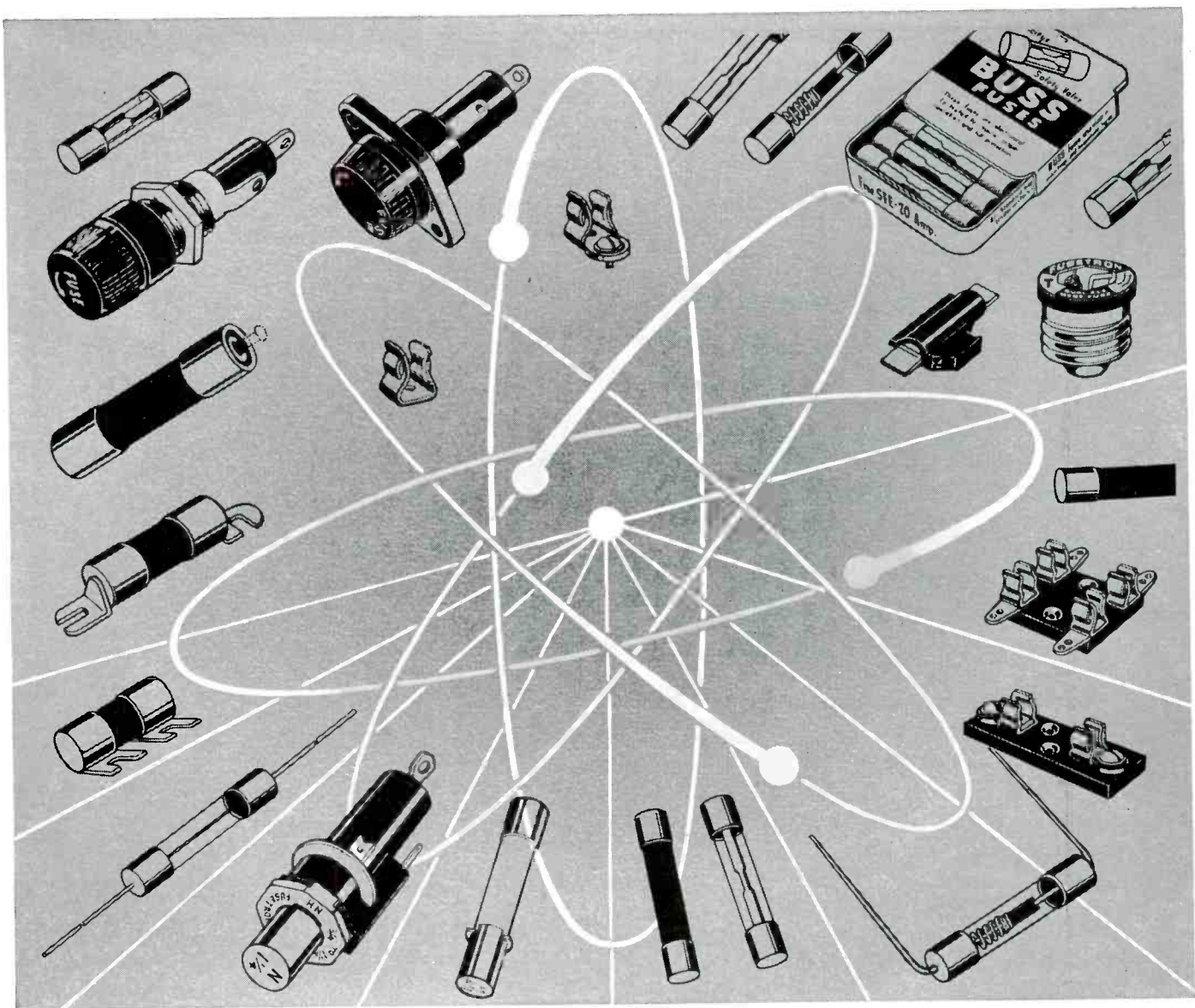

To assure proper operation *under all service conditions* Every BUSS and FUSETRON fuse is Electronically Tested

You can rely on BUSS and FUSETRON fuses for dependable electrical protection because . . . every fuse is tested in a sensitive electronic device that automatically rejects any fuse not correctly calibrated, properly constructed and right in all physical dimensions.

By standardizing on electronically tested BUSS and FUSETRON fuses, you are providing equipment with maximum protection against damage

due to electrical faults. And, you are guarding against the possibility of faulty fuses blowing needlessly and causing unnecessary shutdowns.

Because BUSS and FUSETRON fuses do operate properly, they can help protect the good name of your equipment for quality and service.

Should you have an unusual protection problem, BUSS places at your service the facilities of the

world's largest fuse research laboratory and its staff of engineers. It is possible that these experienced fuse engineers have already solved a problem similar to yours.

For more information on BUSS and FUSETRON Small Dimension fuses and fuseholders . . . Write for bulletin SFB. Bussmann Mfg. Division McGraw-Edison Co. University at Jefferson, St. Louis 7, Mo.

BUSS fuses are made to protect - not to blow, needlessly

1157



MAKERS OF A COMPLETE LINE OF FUSES FOR HOME, FARM, COMMERCIAL, ELECTRONIC, AUTOMOTIVE AND INDUSTRIAL USE.

GATES

Totalizing Recorder

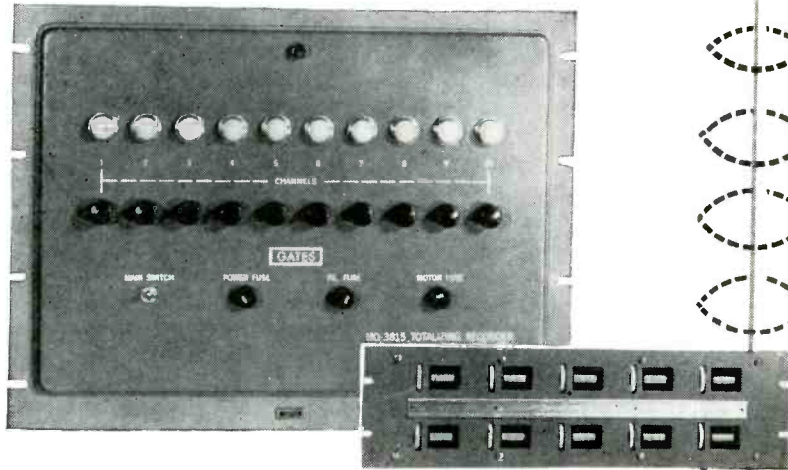

A precision instrument used to record the time a signal is at or above a pre-selected value. Widely employed in measuring field intensity in propagation tests.

Operates from the rectified output of any good quality receiver. Input voltage range is 0 to -10 volts DC. Sensitivity is guaranteed to .05 volts DC input through average readings to .005 volts are not unusual. Any of 10 channels may be set at varied voltage ranges. Isolation between channels permits closeness to .05 volts without interaction.

Each channel, when energized, operates a 1 RPM synchronous motor driven counter reading in 1/10 minutes and totaling to 9,999.9 minutes.

Full detail in the Gates 300-page catalog, Page 235.

Gates M3815 Totalizing Recorder; rack panel size 19" x 14" and 5 1/4" x 19". Drop down to service front panel. For 115 volts, 60 cycles. Price, F.O.B. Quincy, Illinois, \$1375.00.

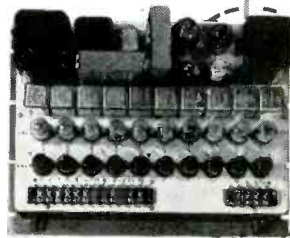

GATES RADIO COMPANY

MANUFACTURING ENGINEERS SINCE 1922

QUINCY, ILL. — OFFICES IN: NEW YORK, WASHINGTON, ATLANTA, HOUSTON, LOS ANGELES

not be overlooked in the search for high temperature resistance.

► **Phenolics**—Although barely out of the development stage, some of the newer low-pressure phenolics bear all the marks of a promising radome material. One drawback is poor thermal shock resistance, important in missiles where surface heating is extremely rapid. Press-molded phenolic laminates blister

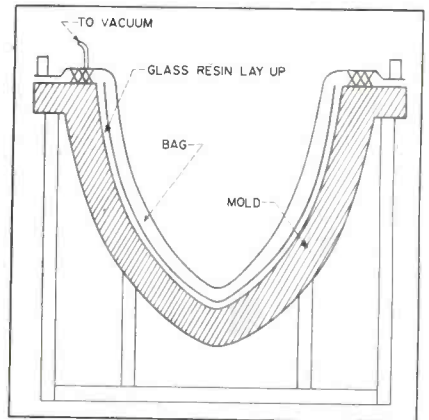

Vacuum bag molding technique for organic radome material

in the 500-600F range, due to entrapped gas within the laminate expanding with heat. Bag molding, using vacuum pressure and a bleeder material, provides an effective method of removing these gases. Bag molding, however, results in a porous laminate which is much more susceptible to oxidation; this in turn means much lower heat resistance.

Recent work in low-pressure phenolics lamination has led to a modification of the curing cycle. This new cycle consists of a press cure at low temperature which advances the resin to a stage in between B stage and full cure. The structure of the material at this point is such that when being post-cured, entrapped gases can still escape by osmosis or vapor transmission. When processed in this manner, phenolics yield laminates with good thermal shock resistance. Equally good results are obtained in bag-molded parts when autoclave pressure (about 100 psi) is used; very little porosity is then noted.

Excellent strength properties are retained up to 750F and even

NEW

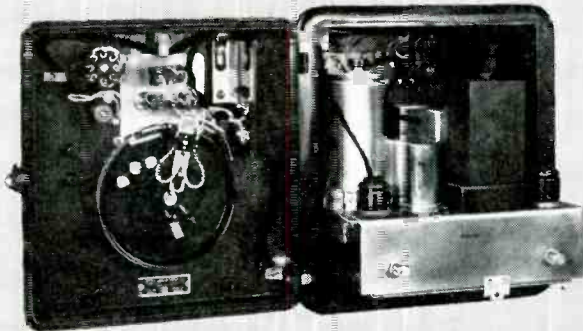

Design simplicity minimizes maintenance; sturdy components resist normal shock and vibration. Precisely calibrated slide wire and circuit resistors hold stability. For easy servicing, amplifier slides out of case; standard vacuum tubes are used . . . their replacement requires no special selection.

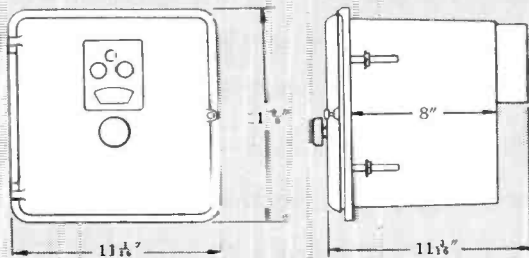

Compact Electromax controller mounts flush in panel. Leads are brought to terminal board located on back of case. Net weight about 27 pounds.

Thermocouple Electromax[®] Controller for temperatures up to 3200 F

- **0.3% LIMIT OF ERROR**
- **10 μ V* CONTROL DEAD BAND**
- **CONTINUOUS STANDARDIZATION**
- **4-WEEK DELIVERY**

*0.5 F for base metal thermocouples; approximately 1.5 F for platinum thermocouples.

Combining all the accuracy and reliability of a modified d-c potentiometer with a drift-free amplifier detector, this new Electromax signalling controller provides low-cost electronic two-position control where a record or continuous indication is not required. It's ideal for many electric and fuel-fired furnaces, ovens, plastic extruding machines, and some types of chemical processing units. Other uses include zone control on continuous ovens and kilns, and excess (overheat) temperature cutout control.

This compact signalling controller has only two moving parts—a plug-in relay and converter (chopper). These, together with simple circuitry and liberal use of plug-in components (including a plug-in amplifier), minimize maintenance and reduce initial cost. To speed start up of your process, Electromax is delivered four weeks after receipt of your order.

Other standard features include both thermocouple and amplifier fail-safe, and automatic reference junction compensation. Amber and red signal lights indicate whether process temperature is above or below set point.

For additional information on the thermocouple Electromax, call your nearest L&N office or write 4979 Stenton Ave., Philadelphia 44, Pa. Ask for Preliminary Data Sheet ND47-33(1).

LEEDS
Instruments



NORTHROP
Automatic Controls • Furnaces

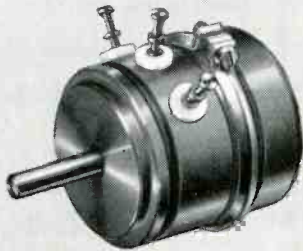
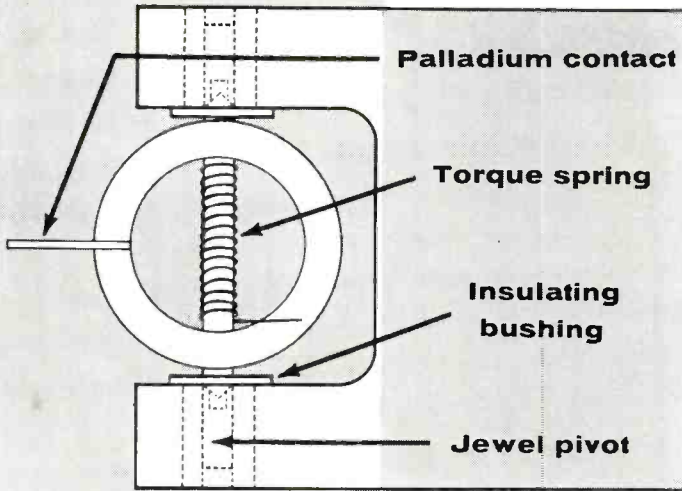

**2,000
CYCLE
VIBRATION!**

Now a totally different mechanical design overcomes limitations of conventional precision potentiometers. The heart of the matter is "dynamic balance" — (1) arm dynamically balanced on shaft (2) contact assembly dynamically balanced on arm. Advantages: low mass, low inertia, long life, .1% linearity, exceptional stability under extremes of vibration, shock and acceleration.

another result of

dynamic balance*

"Dynamic Balance" . . . it's the very essence of the "1000 series" of linear and functional precision potentiometers. It means a new dimension in circuitry design! Proved operationally successful in a variety of military equipments even under severe environmental conditions, "1000 series" pots open the way to reliable electronic systems withstanding higher frequencies and temperatures.

Get complete engineering data on the "1000 series" line. Write today.

electronic components division

Chicago Aerial Industries, Inc.

10265 Franklin Avenue • Franklin Park, Illinois

Incidentally, we know these are hot pots mechanically . . . but they're also hot for temperature, too. Power derates to zero at 165°C standard — 225°C special.

* Patent Pending

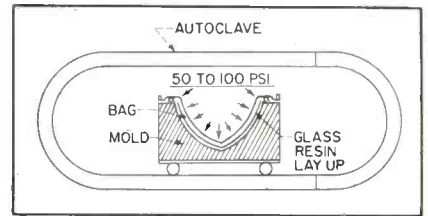

Autoclave molding technique

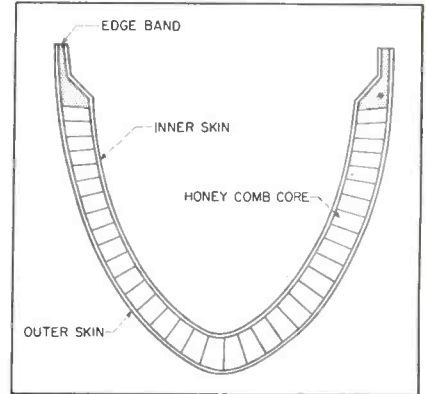

Typical cross-section of honeycomb radome for missile

higher for short periods of time. Phenolics still do not have good electrical properties (dielectric constant 4.6, loss tangent 0.03 at 9,360 mc for 181 fabric laminates), yet they may be considered acceptable for radomes. From a heat resistance standpoint, they are difficult to match in the 500-1,000F range, especially where superior strength is a factor. The modulus of elasticity is well above the modulus of other resins.

► **Silicones**—Silicone resins have good properties in the 750-1,000F range and have been held at 2,000F flame exposure for 15 minutes without fire or burn-through. They appear immune to thermal shock blistering. Electrically, they are satisfactory (dielectric constant 3.7, loss tangent 0.02 at 9,360 mc for asbestos-felt laminates). Room-temperature strength properties and especially interlaminar strength are low.

Like phenolics, silicones are used in preimpregnated form. They may be bag-molded relatively easily. Autoclave molding appears to be a promising fabrication method.

► **Foams and Honeycombs**—Isocyanate foams, which make the bulk of foam radomes, barely reach 250F. Higher temperatures are in

FIRST of the

SIE

ADVANCED
DESIGN
INSTRUMENTS



The

M-3

SIGNAL GENERATOR

- 1 cps—120,000 cps
- Sine and Square Waves
- Less than 0.01% Drift per Hour after Warmup
- Less than 0.1% Distortion in Audio Range
- Frequency Calibration (1% + 0.1 cps)
- Calibrated Attenuator and Output Meter
- A necessity in a fully equipped electronics facility.

The new ADI instruments from SIE are based on an appreciation of the essential requirements for successful design and research instrumentation . . . Accuracy, Versatility, and Reliability. For example: the M-3 Signal Generator — first of the new ADI instruments — is designed to provide the research and design engineer with a highly accurate frequency source for applications ranging from amplifier design to telemetering measurements . . . and to meet these aims in a design which provides maximum "in use" convenience.

There will be new SIE instruments in the ADI Group available in the near future. Watch for their announcement, and, in the meantime, let your SIE representative demonstrate the M-3 in your lab. Check the accurate dial calibration and extremely low drift rate. You'll find a new standard of performance which really deserves the description . . . an Advanced Design Instrument. \$495.00



SOUTHWESTERN INDUSTRIAL ELECTRONICS COMPANY

Industrial Instrumentation for Industrial Progress

2831 Post Oak Road • P. O. Box 13058 • Houston 19, Texas

Measurement Standards



NEW MODEL 1051 C-R-A-M UNIT

Calibrator - Receiver - Amplifier - Mixer

The Model 1051 combines four functions. As a 10 kc to 500 mc frequency standard, it delivers sub-harmonics of a 10 mc oscillator to $\pm 0.0005\%$ accuracy. Discrete sine wave frequencies of 10, 50, 100, 200 kc and 1, 2, 10 mc available from rear terminals. Its 5 mc WWV receiver has a sensitivity of 5 microvolts. The amplifier and mixer sections provide a gain of several hundred times and a comparison of external signals up to 1000 mc or a comparison of external with internal signals. Price \$760.

► **Reinforcements**—Radome laminates combine inorganic reinforcements such as fibrous glass with

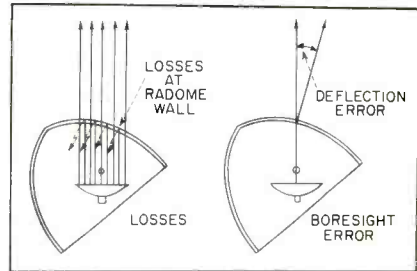

Transmission through typical radome wall, and deflection of beam passing through typical radome wall

organic thermosetting resins. Each of these components has a different coefficient of expansion and a different rate of expansion. It is therefore of utmost importance to provide a good bond between them if good performance is to be achieved over a wide temperature range.

Several finishes for fibrous glass have recently been developed for specific resins, as follows: Polyesters—Volan A, 136, Garan; TAC—OC 301; epoxies—Volan A; phenolics—NOL 24; silicones—112.

Glass begins to soften at 1,200F and is of little value above that temperature. Asbestos fibers retain their properties at higher temperatures. Asbestos laminates and particularly asbestos-phenolic laminates show improved thermal shock resistance over similar glass laminates. While a large amount of design data is now available on fiber-glas laminates, information on asbestos laminates is still scanty.

► **Inorganics**—New supersonic missiles call for an entirely new concept of radome design and manufacture based on inorganic

Crystal Impedance Meters

Four units now available to measure resonance and anti-resonance resistance of quartz crystals, including those covered by Spec. MIL-C-3098B. Capacitance, inductance and performance index (PI) of the crystal can be determined.

Model 531 (TS-683/TSM) covers range of 10-140 mcs, employing 13 calibrating resistors and an anti-resonance adapter for 10-150 ohm crystals. Price \$590.

Model 541A (TS-710/TSM) for 10-1100 kc range crystals having resistances from 200 ohms to 0.5 megohms. Power dissipated in the crystal is measured. Built-in VTVM and ohmmeter provided. Price \$860.

Model 459 (TS-330/TSM) covers 1-15 mc frequency range for crystals having resonance resistances from 0 to 9900 ohms. Price \$695.

Model 1207 (AN/TSM-15) covers frequency range of 75-200 mcs for 10-125 ohm crystals. Crystal voltage at series resonance is measured and power calculated. Built-in ohmmeter.

All models were developed under Signal Corps technical requirements for the national crystal testing standardization program.

Performance of all models is rigidly guaranteed. Prices are net f.o.b. Boonton, N.J. and subject to change without notice.

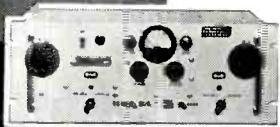

MODEL 531



MODEL 541A

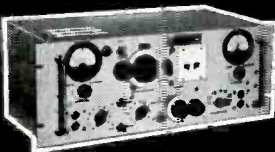

MODEL 459



SEND FOR TECH. DATA

For additional information, including application data, write or phone DE 4-3100. Demonstrators available by local representatives.



Radio Frequency
LABORATORIES, INC.
Boonton, New Jersey, U. S. A.

TYPICAL ELECTRO-SNAP INTERLOCKS

Push to operate;
returns automatically.

Pull to operate;
remains in operating
position until reset for
automatic return by
next full-stroke push
operation.

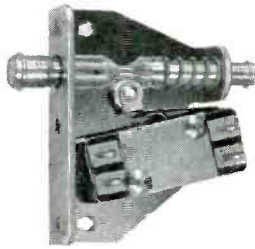

MODEL C2-4 S.P.D.T. 2 ckt. Elec. rating: 125/250 V.A.C., 30 V.D.C. -10 amps. 125 V.D.C., 1/2 amp. 250 V.D.C., 1/4 amp. Oper. force: 2 lbs. = 12 oz. Weight: 2 oz. Dimensions: 1-13/16" x 1-31/32" x 9/16"

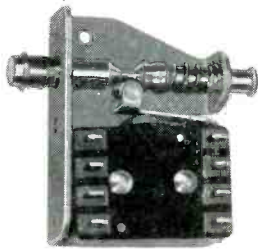

MODEL C2-9 D.P.D.T. Elec. rating: 15 amp. 125/250 V.A.C. 60 cycle. Oper. force: 4 3/4 lbs. ± 12 oz. Amb. temp.: -100° to + 275° F. Elec. & Mech. Life: 150,000 ops. Weight: 2 oz. approx. Dimensions: 1-29/32" x 1-31/32" x 9/16"

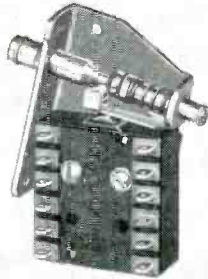

MODEL C2-14 T.P.D.T., 6 ckt. Pre-travel: 5/32" min. Overtravel: 1/4" approx. Mov. Diff. .028" ± .007" Elec. rating: 15 amp. 125/250 V.A.C. -15 amp. 30 V.D.C., res. -10 amp. 30 V.D.C., ind. Life -500,000 ops. min. Dimensions: 2-5/16" x 1-31/32" x 9/16"

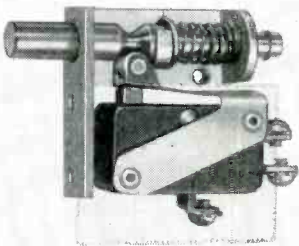

MODEL C2-5 Solid shaft. S.P.D.T. Elec. rating: 10 amps. @ 125/250 V.A.C., 60 cycles. Oper. force: 2 lbs. ± 12 oz. Amb. temp.: -100° to + 275° F. Elec. & Mech. Life: 150,000 ops. Weight: 2 oz. Dimensions: 1-13/16" x 1 7/8" x 1 1/2"

MODEL C2-10 same as C2-5, except has threaded shaft.

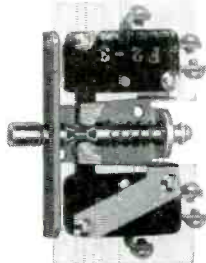

MODEL C2-7 Solid shaft. D.P.D.T. Pre-travel: 3/16" max. Elec. rating: 10 amp. 125/250 V.A.C. 60 cycle. Amb. temp.: -100° to + 275° F. Elec. & Mech. Life: 150,000 ops. Dimensions: 2-3/32" x 1 7/8" x 33/64"

MODEL C2-6 same as C2-7, except has threaded shaft.

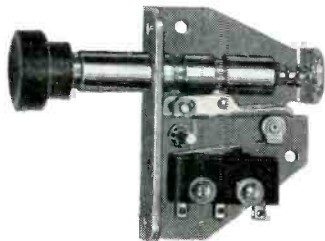

MODEL C2-15—Subminiature interlock. S.P.D.T.; Elec. & Mech. Life and Rating: 150,000 ops. @ 2.5 Amps., 125/250 V.A.C.; 100,000 ops. @ 5 amps, 125/250 V.A.C. Dimensions: 1-13/16" x 1 1/4" x 9/16". Various colored buttons available. (Also available in momentary contact, one-way impulse action.)

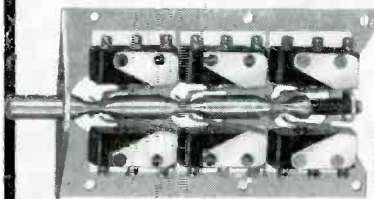

GANGED INTERLOCKS—2 or more switches may be ganged for multiple control with single actuation.

how to cut control costs

with no sacrifice in switch reliability!

These proved-in-use interlock switches are now standard production items at ELECTRO-SNAP

If costs are becoming an increasing problem in your switch and control program, the extensive line of Electro-Snap "standard" switches may point the way to a quick, accurate — and economical — answer!

Designed and built to rigorous original specifications, Electro-Snap "specials-become-standards" are not only sound in theoretical approach. They are also operationally proven . . . in exacting applications.

In short, you *eliminate* all question of correct design, dependability and mechanical long-life — *gain* economy — when you specify a precision-engineered Electro-Snap "standard" for your application.

Check Electro-Snap now. Send details of your particular requirements today for our recommendations and prompt, complete information.



ELECTRO-SNAP SWITCH & MFG. CO.

423 W. Lake Street, Chicago 24, Illinois
VA 6-3100 TWX #CG-1400

Switches and controls are our business —our only business!

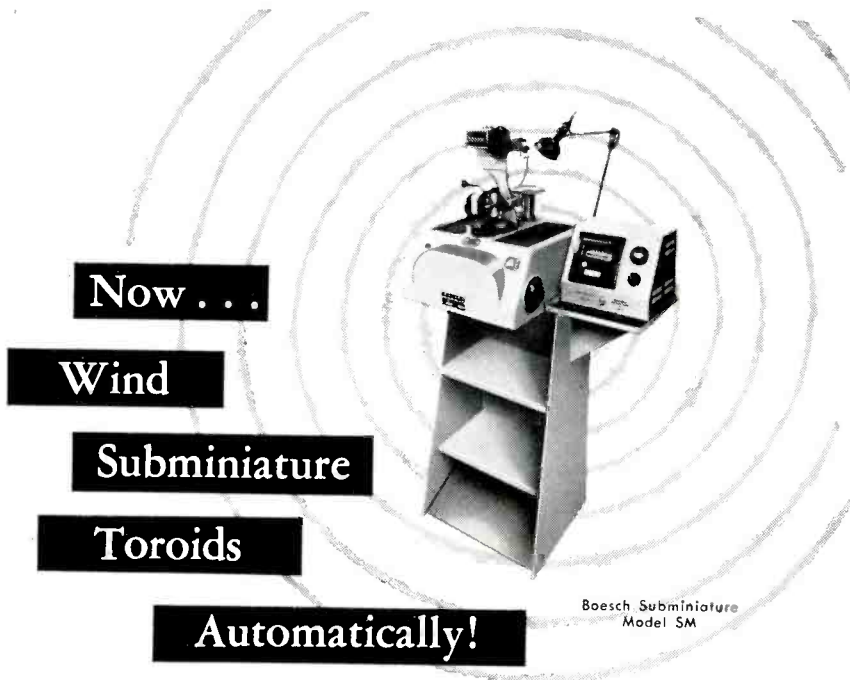

Smaller toroids facilitate new designs —
open new channels to the coil winding industry

Think of the space . . . weight . . . design problems solved by this machine. Coils with IDs of just $\frac{1}{16}$ " . . . maximum ODs of $\frac{3}{4}$ " . . . heights to $\frac{1}{2}$ " wound automatically with wire sizes as fine as #50! Winding speed is continuously variable from 0 to 800 turns per minute and machine equipment includes every accessory you'll need. Reversing mechanism, wire spacing and core rotation direction controls, wire tension device, automatic linear counter, for example, are just a few of the "custom extras" included as basic parts on Boesch SM. The flexibility offered by this revolutionary machine opens fresh new horizons to the coil winding industry. Get complete details on this Subminiature and all Boesch machinery now. Write today for Catalog 57A.

All Boesch Toroidal Winders . . . Fully-Automatic TW 200, Semi-Automatic TW 201 and Subminiature SM feature modern, adaptable design, easy operation, high speed and life-time parts lubrication.

Comparison is the best test of excellence. See for yourself why Boesch manufactures the world's most superior winding machines.



**BOESCH MANUFACTURING
COMPANY, INCORPORATED
DANBURY, CONNECTICUT**

materials. Although very good electrically, these are deficient strengthwise. Among the most promising inorganics is aluminum oxide, which possesses physical properties not much lower than those of organic resins.

Inorganic coatings such as sodium silicate coatings over an organic laminate base may provide some of the answers. All of these materials are still very much in the earlier development stage and face many hurdles. Interesting results have been attained with laminates using inorganic binders with glass and asbestos fiber reinforcements. Up to the temperatures used so far in testing, 750F, these materials showed little loss in strength.

► **Conclusions**—Materials are now available that will perform satisfactorily up to the 750-1,000F range. Radomes can be designed and built to operate within these limits. Above these, a breakthrough in designs and materials is vitally needed. The imagination should perhaps strive toward new concepts such as heat sinks, refrigeration devices or evaporation cooling systems. Such breakthroughs, however, would provide the answer for only a few more steps into the thermal thicket. The Air Force recently reported speeds in excess of 18,000 mph in shock tubes. This means up to 15,000F skin temperature. Such staggering requirements may face us in the not too distant future.

Plastic Envelope Protects Work Orders

TRANSPARENT FILM ENVELOPES made of Bakelite polyethylene protect work orders as they are routed through plants and offices. Orders can be read easily without removing the papers.

A simple polyethylene pressure closure manufactured by Flexigrip, Inc., 504 E. 74th St., New York, N. Y. permits papers to be taken out and replaced easily and quickly if the work order needs notation. The pressure closure consists of two small interlocking ridges that give a complete seal. To open the envelope, it is merely necessary to

NEW LOW-COST RAYTHEON IMPACT GRINDER—\$2790*

***Ultrasonic machine cuts, slices, drills, shapes
germanium, silicon, ferrites, ceramics with speed and precision***



New low-cost Raytheon Impact Grinder uses ultrasonic power to drive abrasive particles at 25,000 cps between the tool and the work. An exact counterpart of the tool is reproduced with speed and precision.



Holes and slots for this ceramic tube spacer are easily cut with the Raytheon Impact Grinder. Use of ceramic, rather than mica, for this tube more than doubles its life. (Photo courtesy C-Mar Corp., Manasquan, N. J.)

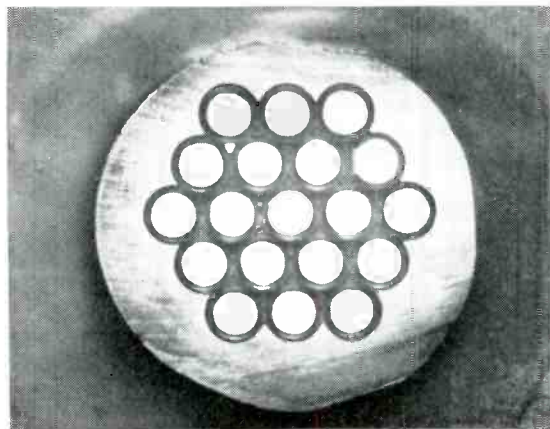

Simultaneous cutting of circular pieces from germanium wafer. Any shape can be cut with speed and precision in hard or brittle materials such as germanium, silicon or ferrite. (Photo twice actual size)

Low-cost version of \$7100 machine cuts limitless variety of shapes in hard or brittle materials. Design engineers welcome new freedom of design it makes possible. Great variety of production and cost problems solved by this versatile new machine.

FREEDOM OF DESIGN

In impact grinding an exact counterpart of the tool is reproduced in the work piece, tool pressure is extremely low and no heat or stress is involved. A limitless variety of shapes can be produced in virtually all hard and brittle materials. To the design engineer, this means that new substances can be used, or that familiar materials can be produced in shapes that formerly were impossible.

For example, the use of a ceramic rather than a mica spacer in the tube shown at left permits much higher tube operating temperatures, better degassing, reduced noise and doubles tube life. Without impact grinding, it is impossible to produce the ceramic spacer with slots and holes sized and positioned with sufficient accuracy.

Square holes can be accurately cut in ferrites. Too brittle to be readily processed by any other means, ferrites are easily drilled or cut with the Raytheon Impact Grinder without disturbing the crystalline structure.

Semiconductors are diced with great ease and can be produced in entirely new shapes. Round, square, delta, oval—any shape that can be fabricated in a soft metal tool can be exactly reproduced in semiconductors.

LOW-COST PRODUCTION

From the production engineer's standpoint, the Raytheon Impact Grinder offers decided cost and time saving advantages. In many instances it vastly simplifies jobs which would otherwise be extremely difficult, time-consuming and costly. In some cases it will even do work formerly considered "impossible". The machine lends itself to economical manufacture of prototypes or full production runs. This compact unit is built to the most exacting electrical and mechanical standards and can be operated by semi-skilled personnel.

APPLICATION ENGINEERING SERVICE

Find out how Raytheon's Impact Grinder can help solve your design and production problems. A Raytheon representative will be happy to demonstrate the machine *in your plant on your own material*, without cost or obligation. For free catalog or to arrange for demonstration, please write Dept. 6120F.



*Price subject to change without notice.

Excellence in Electronics

A-2101

RAYTHEON MANUFACTURING COMPANY
Commercial Equipment Division, Waltham 54, Mass.

Announcing...

**NEW
SPEER
CERAMIC
CASE
COIL...**

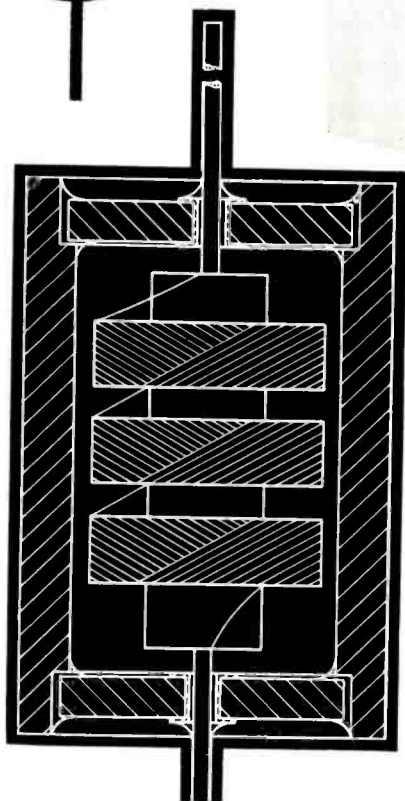
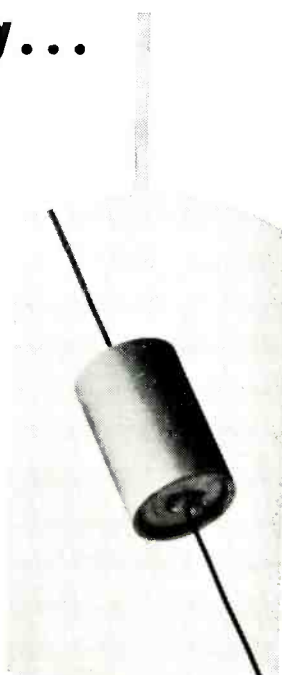

*Non-flammable,
hermetically
sealed . . .
superior to
any tested.*

Now producers of precision electronic equipment have at hand a highly reliable, long-life inductance coil in a hermetically sealed moistureproof ceramic case that is virtually unaffected by atmospheric conditions. Originally developed for use on high-speed computer equipment, it is eminently suited for close tolerance inductance requirements under the most stringent operating conditions.

Protection under all operating conditions, with no interference to the coil's frequency response, is assured by the steatite case.

Exact dimensional conformance of the case makes these coils ideal for automatic assembly.

Performance characteristics and properties of steatite housing materials are well known and defined, while its non-strategic, ample supply avoids possibility of shortage delays.

The new Speer Ceramic Case Coils are available in a complete inductance range up to 20 millihenries, and in a variety of designs, coil forms and physical sizes to meet every requirement. For complete test data and information contact:

JEFFERS ELECTRONICS DIVISION
Speer Carbon Co. Du Bois, Pennsylvania

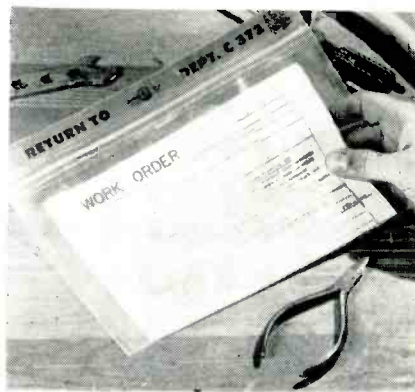

Example of envelope in use

lift one flange to disengage the lock. With the pressure closure sealed, the work order is protected against dirt, chemicals, moisture and finger smudges.

The envelopes are made in four standard sizes by Polyfab Co., 3511 Eagle Rock Boulevard, Los Angeles 65, Calif. An added feature is a slot at the top which can be used to hold identification of the originating department or supervisor.

Making Capacitors by Vacuum Evaporation

HIGH-TEMPERATURE equivalents of conventional paper capacitors have been made experimentally by Servomechanisms, Inc., El Segundo, Calif. by vacuum evaporation.

A small alumina cylinder is placed in a vertical position on a motor-driven pedestal in the center of the vacuum chamber. Located around the periphery of the vacuum chamber at 90-degree intervals are four vapor sources two of dielectric material and two of metal conductors, alternately spaced. Between these sources and the alumina core is a cylindrical mask having four vertical slits, one in front of each vapor source.

When the chamber is pumped down, the pedestal motor is started so the alumina core rotates. Now when the four sources are brought up to vaporization temperatures, streams of vapor pass through the four slits and deposit alternate metal and dielectric films on the core, to build up the familiar wound capacitor construction. Each metal film starts at one of the two terminal strips initially deposited on the core with special masks.



At the heart of the missile . . . time division multiplexing by ASCOP. 3 poles 27 channels @ 10 RPS, 3 poles 27 channels @ 5 RPS, 400 cycle drive. Proven reliability in 25,000 hours of life testing. Engineered to withstand environmental conditions experienced on the most advanced missile programs.

 **ASCOP**

ELECTRO-MECHANICAL DIVISION

HIGH LEVEL SAMPLING SWITCHES • LOW LEVEL SAMPLING SWITCHES • DISPLAY COMPONENTS • CONTROL EQUIPMENT • COMPARATORS • SENSING SYSTEM ELEMENTS
FUNCTION GENERATORS • TELEMETERING MULTIPLEXERS AND CALIBRATORS • DRIFT COMPENSATORS • THERMOCOUPLE SAMPLERS • MECHANICAL OSCILLATORS

APPLIED SCIENCE CORPORATION OF PRINCETON

P. O. BOX 44, PRINCETON, NEW JERSEY
Plainsboro 3-4141

15551 CABRITO ROAD, VAN NUYS, CALIFORNIA
State 2-7030

1 NORTH ATLANTIC AVENUE, COCOA BEACH, FLORIDA
Cocoa Beach 3900

New Products

Edited by WILLIAM P. O'BRIEN

84 New Products and 9 Manufacturers' Bulletins Are Reviewed
. . . Control, Testing and Measuring Equipment Described and
Illustrated . . . Recent Tubes and Components Are Covered

TV UV MICROSCOPE

and microspectrophotometer

NEUTRONICS RESEARCH Co., 165 Lake St., Waltham, Mass., has developed a color translating tv ultraviolet microscope.

Basically, the microscope operates as follows: Three ultraviolet-monochromators supply the three preselectable ultraviolet or visible wavelengths. A substage rotating mirror system brings these sequentially into a 2,000A or 7,000A apochromatized microscope sys-



tem. An identical post-ocular rotating mirror separates in space the three UV absorption images of specimen onto three UV-Vidicon cameras, respectively.

Microspectrophotometry is performed by selecting any one of the horizontal scan lines and displaying its density variation across the specimen on a line-analyzer oscilloscope. The microscope is essentially electronic as opposed to the mechanical-optical design of previous models. Price is \$37,500. **Circle 401 on Reader Service Card.**

MINIATURE MICROPHONE

is precision-built

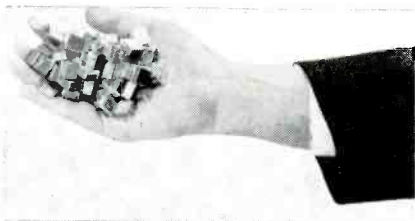

SHURE BROTHERS, INC., Evanston, Ill., announce the new rugged MC30 controlled magnetic microphone designed for use by manufacturers of hearing aids, communication equipment, tape recorders and dictating equipment.

The half-in. square microphone is precision produced and features quality performance, uniformity and dependability.

Size is $\frac{1}{2}$ in. by $\frac{1}{2}$ in. by $\frac{1}{4}$ in. and weight 3.7 grams. Output is—76 db at 1,000 cps; response, 400 to 4,200 cps; impedance, 1,850 ohms at 1 kc. **Circle 402 on Reader Service Card.**

RUGGEDIZED PLUG-INS

meet MIL-E-5272A tests

ENGINEERED ELECTRONICS Co., 506 East First St., Santa Ana, Calif., has available a complete series of ruggedized plug-ins for designing and building automation systems. This line of rugged systems building blocks speeds the design of timing systems, automatic control systems, data handling, computing and automation systems.

The new group of EECO ruggedized plug-ins includes: cathode followers, pulse gates, squaring circuits, gate amplifiers, d-c amplifiers, reset generators, one-

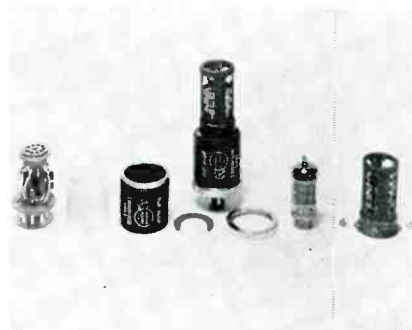

shots, flip-flops, gates, crystal oscillators, multivibrators, pentagrids, amplifiers, phantastrons, voltage

regulators, blocking oscillators, thyatron ring counters and thyatron pulse generators. **Circle 403 on Reader Service Card.**

PULSE GENERATOR

useful to computer field

AMERICAN ELECTRONIC LABORATORIES, INC., 121 North 7th St., Philadelphia, Pa., announces the 138 pulse generator. This instrument produces pulses over the range of one microsecond to one second—singly, recurrently, single pairs, recurrent pairs, single trains



Leadership is hard to achieve and even harder to maintain. A stroke of genius or a lucky break may put you on top, but it takes stability of organization and persistent *product dependability* to keep you there. More C-D capacitors are sold because C-D capacitors are made better—not just in one big order, but in every order every year. Our leadership is added insurance for yours, because it is based on the high quality of every CORNELL-DUBILIER capacitor since 1910.

Write for catalog to Cornell-Dubilier Electric Corporation, South Plainfield, New Jersey.

Two of Thousands of C-D's Mica Types:

CERAMIC-CASED HIGH-POWER MICAS: Built to handle efficiently and economically the high kva requirements of transmitters, induction heaters, Loren circuits and a variety of other high-current equipment for military, communications and industrial applications.

"SUPER MICADONS*": An entirely new concept in quality midget mica capacitor construction. Greatly increased capacitance over that of conventional units of the same case size.



CONSISTENT HI-DEPENDABILITY
CORNELL-DUBILIER CAPACITORS



SOUTH PLAINFIELD, N. J.; NEW BEDFORD, WORCESTER & CAMBRIDGE, MASS.; PROVIDENCE & HOPE VALLEY, R. I.; INDIANAPOLIS, IND.; SANFORD, FUGUAY SPRINGS & VARINA, N. C.; VENICE, CALIF.; & SUB.: THE RADIART CORP., CLEVELAND, OHIO; CORNELL-DUBILIER ELECTRIC INTERNATIONAL, N. Y.

and recurrent trains. The output is reversible and supplies 35 v into 50 ohms.

The instrument should be useful to those engaged in the fields of

sonar, digital computers, acoustics, countermeasures, geophysics, analog computers and radar.

Repetition frequencies from less than 1 cps to 250 kc are available

internally. The instrument will follow external sync anywhere in this range aperiodically or periodically. **Circle 404 on Reader Service Card.**

DYNOGRAPH RECORDER

features up to 19 channels

OFFNER ELECTRONICS INC., 5320 North Kedzie Ave., Chicago 25, Ill., has in production a new Dynograph direct-writing oscillograph recorder, the type 503. The new unit, a mobile console assembly is designed for applications requiring more than 8 channels of information on one recording chart. Up to 19 recording channels are available in the type 503 Dynograph, using either ink or electric curvilinear recording. The manufacturer supplies 24½ in. printed paper, either in roll or folded form, and 500 ft unprinted rolls as desired.



Pen spacing of 2 in. is normally provided with assemblies of 12 channels or less, and pen spacing of 1¼ in. with assemblies of 13 through 19 channels. Other pen spacing can be supplied if desired. The paper is driven by a synchronous motor and eight speed gear box, providing instant selection of speeds of 1, 2.5, 5, 10, 25, 50, 100, and 250 mm per sec, accurate to 1 percent. Paper is driven from both edges.

The new type 503 Dynograph recorder features fast response, high sensitivity, and absolutely drift-free recording through the use of the patented chopper amplifier developed by Offner. **Circle 405 on Reader Service Card.**

MYLAR CAPACITOR

is metallized component



ASTRON CORP., E. Newark, N. J., announces a new Mylar metallized capacitor, type RQL. This miniature unit in a hermetically sealed case is extremely reliable at temperatures up to 125 C without derating.

Type RQL is available in a wide range of case styles and constructional variations similar to those from type CPO4 through CPO11 in Mil-C-25A. Electrical specifications of MIL-C-18312, the military specification recently issued by the U. S. Navy for metallized capacitors, are met. **Circle 406 on Reader Service Card.**

BEAM SWITCHING TUBE

with high input impedance

BURROUGHS CORP., Electronic Tube Division, Plainfield, N. J., has available a full line of magnetron beam switching tubes. Featuring high input impedance and ten individual constant current outputs, these beam switching tubes may perform the functions of 20 or more tubes or transistors. It is compatible with tubes, transistors, cores, thyratrons, relays, Nixie numerical indicators and other devices.

This high vacuum electronic dis-



tributor has an estimated life span of 50,000 hours. Characteristics of the tube line include shock,

375 g; temperature range of -60 to +150 C; vibration, 20 g; and a speed up to 20 mc.

Type 6700 operates between 75 to 300 v with a switching rate above 2 mc and type 6701 from 12 to 25 v with a switching rate above 1 mc. Type MO-10R is the same as 6700 except that it has ten internally mounted space load vacuum resistors to permit operation at higher frequencies and with a reduced number of external stem leads.

Versatile, the beam switching tube is now in use in instruments, industrial control computers, tele-



"Missiles are a different breed of animal!"

YOU hear that statement often these days, as engineers and production men shift their thinking to meet the dawning missile age.

For the past 10 years "ultra-reliability" has been the byword at Electro Tec Corporation.

We have achieved it by developing unique designs and methods that now place us in a leading position to meet the even greater emphasis placed upon reliability by the stringent requirements of missile control and guidance systems.

It costs no more to have the assurance of Electro Tec's "ultra-reliability" — and it is rooted in demonstrable scientific facts.

Take our slip ring assemblies, for example:

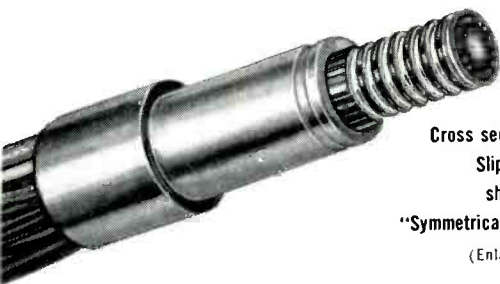

Cross section of 34-ring
Slip Ring Assembly
showing exclusive
"Symmetrical Construction."
(Enlarged 1 1/2 times)

"Ultra-reliability" for the missile age.

* U. S. Pat. 2,696,570. Other patents pending.

1. **Mechanical stability under high temperatures, shock and vibration**, and greater strength are the result of **symmetrical construction** throughout, and the use of a hardened center wire. (See illustration at left.)

2. **Ultra-reliable electrical performance**, lowest noise levels, more uniform wear because the exclusive* Electro Tec processes permit the use of pure **24K gold** and fine silver instead of alloys.

3. **Molecular bond*** of ring to wire assures positive, permanent connections under high temperature, shock and vibration.

These are the points of Electro Tec superiority that add up to "ultra-reliability" in the air and on the shelf — now . . . or *three years from now!* Electro Tec Sales Engineers are available in all parts of the country. Write to:

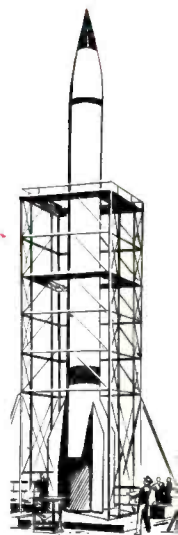

ELECTRO TEC CORP.

South Hackensack, N. J.

Products of Precision Craftsmanship





no magic . . .
just expert
know-how . . .

TRANSPAC[®] Transistorized DC-AC INVERTERS

Transpac[®] semi-conductor inverters convert low voltage DC into AC, eliminating the disadvantages inherent in rotating or vibrating mechanical equivalents. These designs also incorporate exclusive features found only in the ERA line . . .

® Trade Mark Registered

'E' CORE DESIGN . . . decreases effect of temperature and environmental conditions. Uniform performance unit to unit.

SELF STARTING . . . utilizes diode starting network for positive starting under all operating conditions.

ADJUSTABLE FREQUENCY . . . incorporates frequency adjustment control permitting exact setting for any given input or output conditions.

SYNCHRONIZING INPUT . . . provision for external synchronization for exact frequency duplication of outside frequency source.

DE-SPIKING NETWORK . . . prevents build-up of excessive voltages insuring long life and reliable operation.

RELIABLE DESIGN . . . no damage due to accidental reversal of polarity. Overload and short circuit protected.

STANDARD MODELS

Model No.	Input VDC	Output VAC	Output VA	Frequency cps	Size Inches	Weight Pounds	Price, FOB Factory
IT616	6	115	15	60	C	2.0	\$70
IT614	6	115	15	400	B	1.0	70
IT126	12	115	25	60	D	2.7	80
IT124	12	115	25	400	C	2.0	80
IT226	24	115	25	60	D	2.7	80
IT224	24	115	25	400	C	2.0	80
IT256	24	115	50	60	E	4.0	95
IT254	24	115	50	400	D	2.7	95

Case Size, WxDxH Ins.: "B" 2-3/8, 2-3/4, 2-13/16; "C" 2-3/8, 2-3/4, 3-13/16; "D" 2-5/8, 3-1/6, 4-1/4; "E" 3-1/6, 3-9/16, 4-7/8; "F" 3-7/8, 3-7/8, 4-3/4.

Custom designs and additional standard model inverters and converters also available. Write for literature and quotations on special designs.

Manufactured at ERA's New and Larger facilities.

**Electronic Research
Associates, Inc.**

67 Factory Place, Cedar Grove, N. J.

CEnter 9-3000

metering, radar and many other military applications as well as the Burroughs decade counter with a Nixie readout. Applications for frequency dividing, timing and multiposition distributing are limitless. Circle 407 on Reader Service Card.

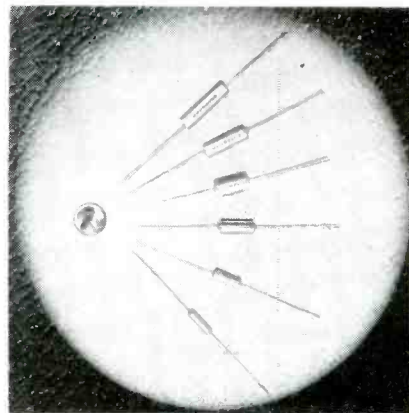

ELECTROLYTICS

miniature aluminum type

THE MAGNAVOX Co., Fort Wayne 4, Ind. Miniature aluminum electrolytic capacitors, having only a few μ a of electrical leakage, have been developed. Ratings range from 1 to 125 μ f and 4 to 150 v d-c. Permissible operating temperature range is -20 C to $+85$ C. Lengths range from $\frac{3}{8}$ in. to $1\frac{1}{4}$ in. and diameters from $\frac{1}{8}$ in. to $\frac{3}{16}$ in. Centered axial leads permit automatic insertion in printed circuit boards. The case is electrically insulated and is effectively sealed with epoxy casting resin. Circle 408 on Reader Service Card.

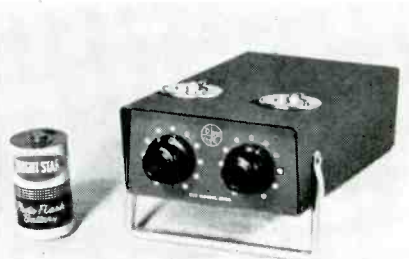

AUDIO EQUIPMENT

is transistorized

DUNLAP ELECTRONICS INC., 764 Ninth St., Des Moines, Iowa. The TM series of audio equipment has been designed with the maximum

New

X-500 Sub-Miniature ACEPOT* rated to 150° C.

ACEPOT* - ACETRIM* sub-miniature, precision wire-wound potentiometers and trimmers are shooting to new highs!

X-500 "Hotpot" operates from -55° C. to 150° C.
 $\frac{1}{2}$ " size
up to 250K
 $\pm 3\%$ linearity
proved in use

ACEPOTS and ACETRIMS meet unusually rigid functional and physical requirements and are setting new standards for dependability in sub-miniaturization. The designs are the result of 4 years' development and over a year of successful use by leading electronic and aircraft equipment manufacturers.

Condensed Engineering Data

	ACEPOT (potentiometer)	ACETRIM (trimmer)
Resistance Range	10 \sim to 250K $\pm 2\%$	10 \sim to 150K $\pm 3\%$
Size	$\frac{1}{2} \times \frac{1}{2}$ "	$\frac{1}{2} \times \frac{1}{2}$ "
Linearity	$\pm 3\%$	$\pm 3\%$
Resolution	extremely high	excellent
Ambient Temperature	-55° C to 150° C	-55° C to 125° C
Torque	low or high	low or high

The above specifications are standard — other values on special order.

All units sealed, moistureproofed, and anti-fungus treated. Meet applicable portions of JAN specs and MIL-E-5272A standards.

Ace also offers larger size precision potentiometers, to RETMA specifications, manufactured to highest standards to meet your most rigid requirements. Expedited delivery from special order section.

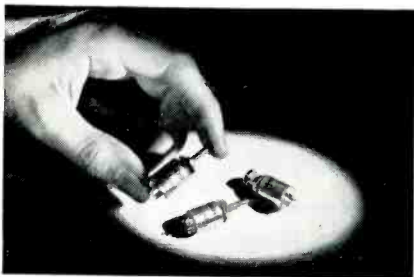

For applications where you must be positive, answer your potentiometer and trimmer needs with space and weight saving, highly accurate and dependable ACEPOTS and ACETRIMS.

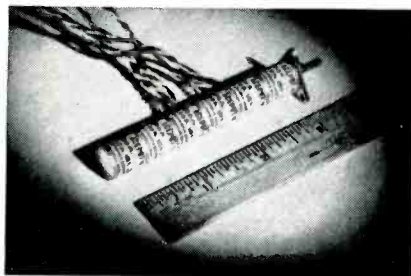

Available in threaded bushing, servo, flush tapped hole or flange mounts, and ganged units. Special shaft lock is self-contained. Internal stops and taps as required. Indexing pin provides non-rotational mounting.

Expedited delivery on prototypes; prompt servicing of production orders. Write for Fact File and application data sheets.

*trademarks applied for

ACEPOT*
ACETRIM*

ACE ELECTRONICS ASSOCIATES

Dept E, 101 Dover St. • Somerville 44, Massachusetts

of reliability and portability. The units use an etched circuit combined with transistors to obtain long and trouble-free life. Total interaction of the mixer stages does not exceed 1 db at any setting of the gain controls. The battery life exceeds 60 hours for an approximate operating cost of 2 cents per hr.

The mixer units have been designed to fit in the film storage compartment of the Auricon "Sound on Film" camera and have been used to give much better recording characteristics with the Auricon camera.

The TM-2 uses 3 transistors and the TM-4 uses 5 transistors in low noise temperature stabilized circuitry. Literature available gives options and ordering combinations and prices. Circle 409 on Reader Service Card.

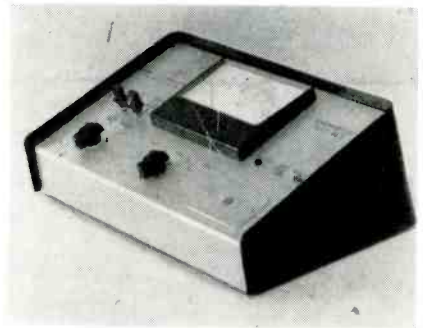

TRANSISTOR TESTER

determines basic parameters

ARMOUR ELECTRONICS, INC., 10800 Ventura Blvd., Studio City, Calif. An accurate system has been designed into this instrument to determine the basic parameters of a transistor. Beta and I_{co} are determined as well as figure of merit, I_{bco} . This I_{bco} can well be relied upon to denote the quality factor for it involves collector current leakage, emitter current leakage, transistor gain, base and emitter resistances.

The test set accurately measures Beta, I_{co} , and I_{bco} of both *pn*p and *np*n type transistors at any desired operating level assuring the flexibility required for circuit design. Component matching accuracy of approximately 2 percent is provided. Simplicity of the control panel and testing procedure makes the tester compatible with the requirements

*The most complete line
of radar antennas
comes from* **KENNEDY**

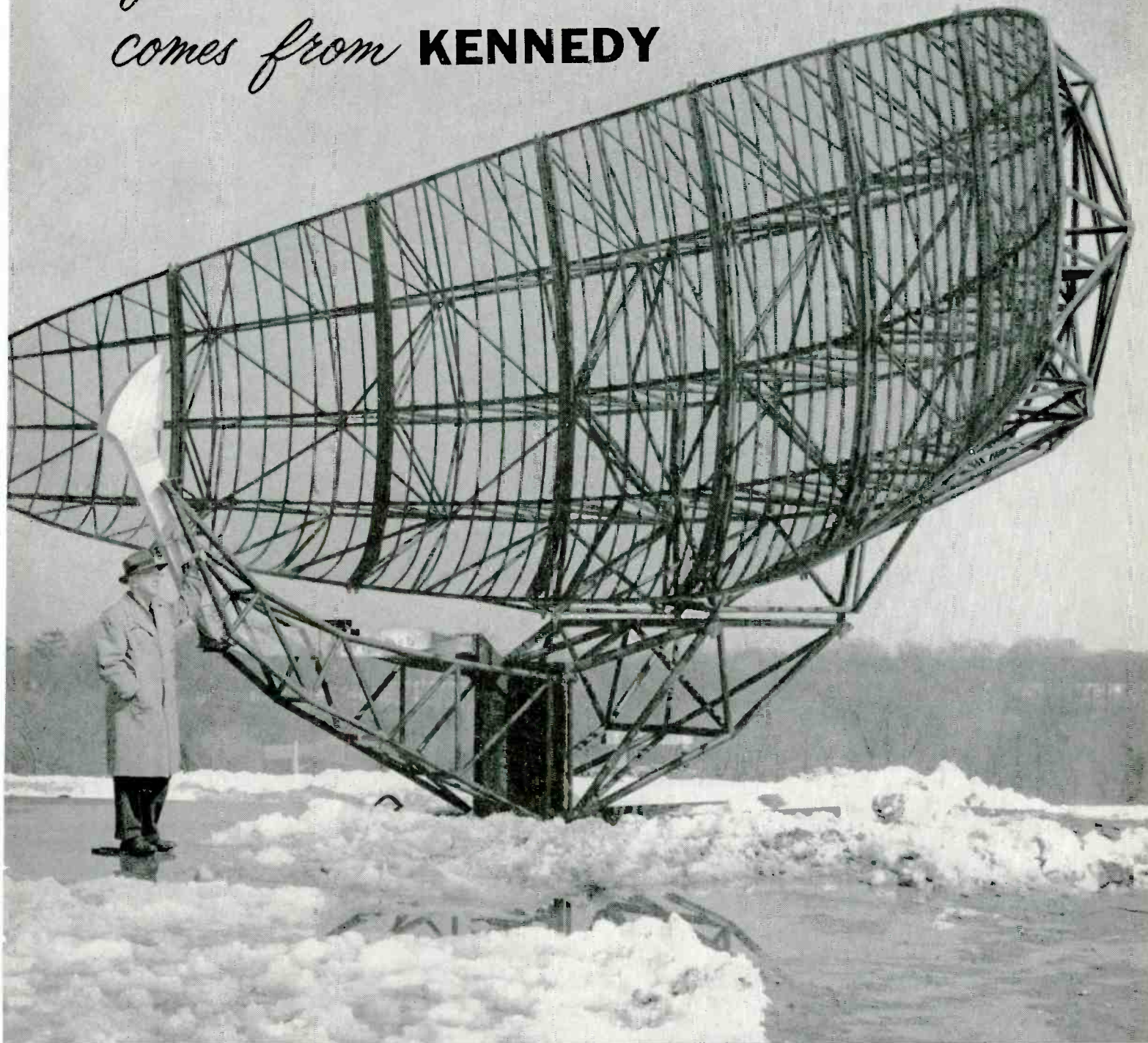

ONE of many designs that have helped make the name Kennedy synonymous with advanced radar antenna development, this new long range reflector measures 40' from tip to tip, features sectionalized aluminum construction for ease of transportation and erection, meets military specifications for all-weather reliability.



ANTENNA EQUIPMENT

D. S. KENNEDY & CO.

COHASSET, MASS. — TEL: CO4-1200

*Down-To-Earth SOLUTIONS to
Out-Of-This-World PROBLEMS*

Tracking Antennas
Radio Telescopes
Radar Antennas
"Trans-Horizon" Antennas
Ionospheric Scatter
Tropospheric Scatter

SAR PULSESCOPE

by

Waterman

PRICE:
\$995.00

MODEL S-4-C

**DIRECT-READING
DELAYED SWEEP
ACCURATE TO
0.1%**

Size:
9 1/8" x 11 1/4" x 17 1/4"
31.5 Pounds

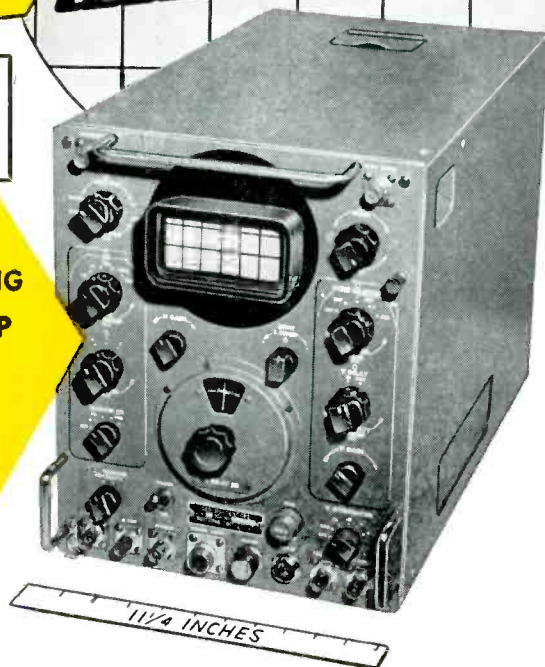

ANOTHER EXAMPLE OF *Waterman* PIONEERING...

The SAR PULSESCOPE, model S-4-C, is JANized (Gov't Model No. OS-4), the culmination of compactness, portability, and precision in a pulse measuring instrument for radar, TV and all electronic work. An optional delay of 0.55 microseconds assures entire observation of pulses. A pulse rise time of 0.035 microseconds is provided thru the video amplifier whose sensitivity is 0.5V p to p/inch. The response extends beyond 11 mc. A and S sweeps cover a continuous range from 1.2 to 12,000 microseconds. A directly calibrated dial permits R sweep delay readings of 3 to 10,000 microseconds in three ranges. In addition, R sweeps are continuously variable from 2.4 to 24 microseconds; further expanding the oscilloscope's usefulness. Built-in crystal markers of 10 or 50 microseconds make its time measuring capabilities complete. The SAR PULSESCOPE can be supplied directly calibrated in yards for radar type measurements. Operation from 50 to 400 cps at 115 volts widens the field application of the unit. Countless other outstanding features of the SAR PULSESCOPE round out its distinguished performance.

WATERMAN PRODUCTS CO., INC.

PHILADELPHIA 25, PA.
CABLE ADDRESS: POKETSCOPE

MANUFACTURERS OF

PANESCOPE®
S-4-C SAR PULSESCOPE®
S-3-C LAB PULSESCOPE®
S-11-A INDUSTRIAL POKETSCOPE®
S-12-B JANIZED RAKSCOPE®
S-12-C SYSTEMS RAKSCOPE®
S-14-A HIGH GAIN POKETSCOPE®
S-14-B WIDE BAND POKETSCOPE®
S-14-C COMPUTER POKETSCOPE®
S-15-A TWIN TUBE POKETSCOPE®
RAYONIC® Cathode Ray Tubes
and Other Associated Equipment

*T. M. REG.

MEMO...
Write
for
details
today!

W

WATERMAN PRODUCTS

of high rate quality control testing.

Modern circuit techniques are used throughout the unit which weighs only 4 1/2 lb and is enclosed in a cabinet 5 in. high, 11 in. wide, and 9 in. deep. All electrical power is derived from four mercury cells. The test set is priced at \$96. Circle 410 on Reader Service Card.

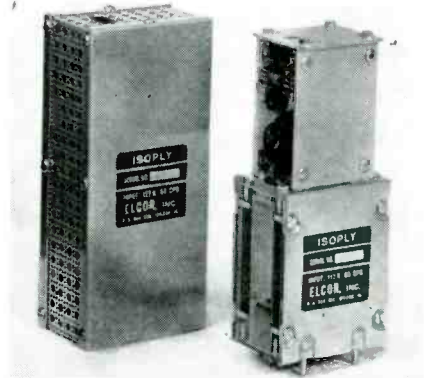

STRAIN-GAGE SUPPLY transistor regulated

ELCOR INC., P.O. Box 354, McLean, Va., has available a new line of low-voltage transistor-regulated Isoplys designed especially for strain-gage bridges, and other applications requiring an ungrounded low-noise power supply. Models A8/10-100A and A11/13-100A employ the same low-capacitance transformer construction used in other Isoplys. The low value of shunt capacitance (40 μf with ventilated metal cover) and the special transformer shielding make the supply suitable for such applications as: (1) bridge circuits requiring an off-ground low-noise supply; (2) high-speed direct-coupled circuits requiring an ungrounded supply; and (3) special circuits requiring a floating supply for bootstrapping. This supply is well suited to conventional use, especially transistor circuits where either + or - terminal is grounded.

These models feature adjustable regulated outputs of 8-10 v d-c or 11-13 v d-c conservatively rated at 100 ma. Regulation with respect to load is 0.4 percent no load to full load. With respect to line voltage change the regulation is better than 0.2 percent for a 10 percent change in line voltage. Change in output voltage with re-

Waveguide Pressure Windows

...new techniques result in increased reliability

Does your problem involve reliable, low loss hermetic sealing at microwave frequencies? If so, Microwave Associates' large selection of over 50 different waveguide pressure windows is the answer.

Our windows include 20 flange mounted and 29 solderable types ranging in frequency from 2800 to 70,000 mc/s. Designed and produced by personnel combining years of experience in both microwave and glass-to-metal sealing techniques, these windows are indispensable for sealing both high and low power microwave devices such as ferrite isolators, antenna, duplexer and filter assemblies and many types of test equipment.

These windows are exclusively fabricated by melting glass into one or more slots of pre-oxidized kovar. The resulting structure is vacuum tight, broadband, low loss and especially resistant to wide varieties of thermal and mechanical environments. Kovar-glass windows can be repeatedly cycled over wide pressure differentials without danger of fracturing, a defect often encountered with windows fabricated from other materials. Microwave Associates' windows are silver plated and designed for convenient installation.

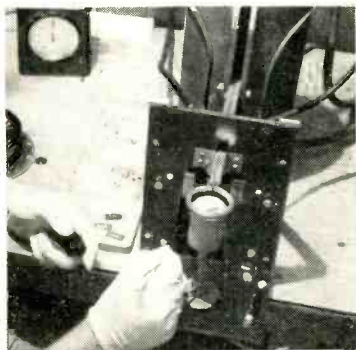

Glass-kovar sealing a highly critical operation, has been perfected at Microwave Associates, Inc. to produce pressure windows of exceptional quality.

SEND FOR DATA
Write for catalog CP11-1, a 4 page brochure filled with design and application data.

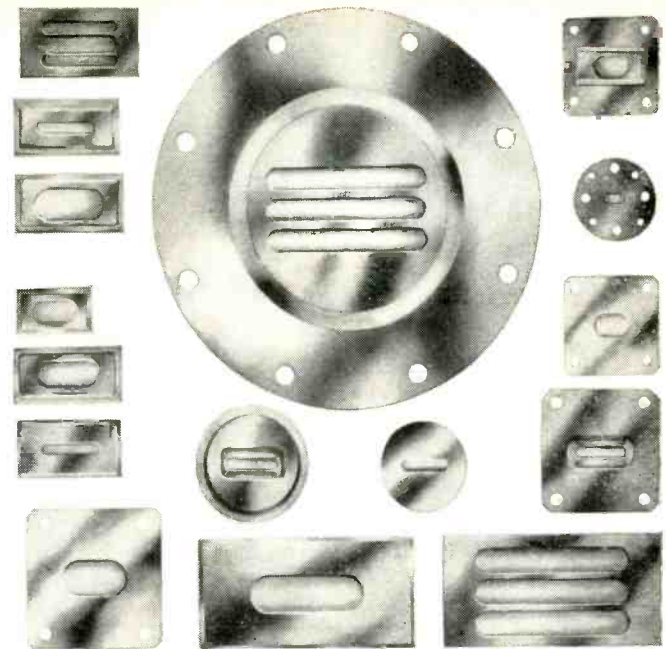

FLANGE MOUNTED TYPES

Model	Band	Center Freq. (MC)	Freq. Range (KMC)	Max. VSWR Band Edges	Peak Power (KW)	Waveguide Size RG—	Max. Pressure (PSI)
MA1326	S	2800	2.45-3.15	1.25	1200	48/U	45/30
MA1352	C	6800	5.85-8.2	1.25	500	50/U	45/30
MA1347	C	7540	7.0-8.1	1.10	750	50/U	45/30
MA1329	Xc	9000	7.5-10.0	1.15	500	51/U	45/20
MA1329A	Xi	9000	7.5-10.0	1.15	320	51/U	60/30
MA1330A	X	9000	8.4-9.6	1.15	200	52/U	60/30
MA1344	X	9000	8.5-9.6	1.08	300	52/U	45/30
MA1349	X	9600	9.3-9.9	1.10	20	2X.91D	45/30
MA1330B	X	9800	8.2-12.4	1.20	200	52/U	60/30
MA1345	X	9800	8.2-12.4	1.20	300	52/U	45/30
MA1339	X	9800	9.5-10.1	1.10	20	2X.91D	45/30
MA1333B	Ke	13500	12.8-14.2	1.10	125	91/U	45/30
MA1340	Ke	13500	12.8-14.2	1.10	125	91/U	45/30
MA1333A	Ku	15000	12.4-18.0	1.20	125	91/U	45/30
MA1342	Ku	15000	12.4-18.0	1.20	125	91/U	45/30
MA1333C	Ku	16000	15.2-16.8	1.10	125	91/U	45/30
MA1341	Ku	16000	15.2-16.8	1.10	125	91/U	45/30
MA1348	K	24000	18.0-26.5	1.15	70	53/U	45/30
MA1334	Ka	34860	33.25-36.5	1.10	40	96/U	45/30
MA1346	V	70000	65-75	1.10	12	98/U	45/30

SOLDERABLE TYPES

MA1318	S	2800	2.75-2.85	1.25	170	48/U	60/45
MA1325	S	2800	2.45-3.15	1.25	1200	48/U	45/30
MA1306	S	3300	3.25-3.35	1.25	170	48/U	60/45
MA1351	C	6800	5.85-8.2	1.25	500	50/U	45/30
MA1321	X	8800	8.5-9.1	1.25	100	52/U	60/45
MA1301	X	9000	8.8-9.2	1.25	20	52/U	60/45
MA1310	X	9000	8.8-9.2	1.25	20	52/U	45/30
MA1320	Y	9000	8.7-9.3	1.25	100	52/U	60/45
MA1327	X	9000	8.4-9.6	1.25	150	52/U	45/30
MA1338	X	9000	8.4-9.6	1.08	200	52/U	60/30
MA1350	Xi	9000	7.5-10.0	1.15	320	51/U	60/30
MA1302	X	9200	8.9-9.5	1.25	100	52/U	60/45
MA1312	X	9310	9.0-9.6	1.25	100	52/U	60/45
MA1353	X	9310	9.1-9.7	1.25	100	52/U	60/45
MA1319	X	9375	9.1-9.7	1.25	100	52/U	60/45
MA1317	X	9600	8.35-11.0	1.25	200	52/U	60/30
MA1322	X	9600	9.3-9.9	1.25	100	52/U	60/45
MA1303	X	9800	9.5-10.2	1.25	150	52/U	45/30
MA1324	X	9800	9.6-10.0	1.25	20	52/U	45/30
MA1331	X	9800	9.6-10.2	1.10	150	52/U	45/30
MA1350A	Xi	9800	8.6-10.6	1.15	320	51/U	60/30
MA1311	X	9900	8.2-12.4	1.25	200	52/U	60/30
MA1323	X	9900	9.6-10.2	1.25	100	52/U	60/45
MA1354	X	10125	9.8-10.4	1.25	100	52/U	60/45
MA1314	X	10150	9.8-10.55	1.25	150	52/U	45/30
MA1328	X	10700	10.0-11.4	1.25	150	52/U	45/30
MA1336	Ke	13500	13.0-14.0	1.25	40	91/U	45/30
MA1337	Ku	16000	15.4-16.6	1.25	40	91/U	45/30

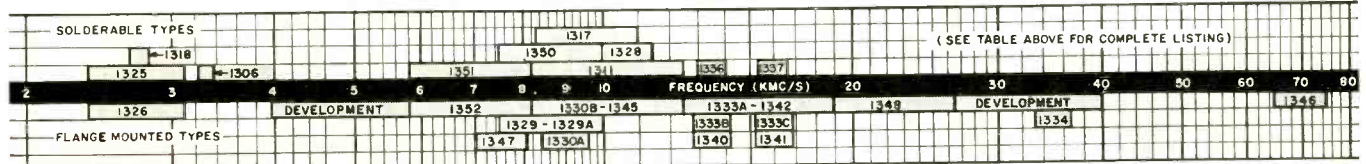

MICROWAVE ASSOCIATES INC.

Burlington, Mass.
BUrlington 7-2711

potter

GLASS
ENCLOSED
PLASTIC
FILM

CAPACITORS

Silicone Oil Impregnated

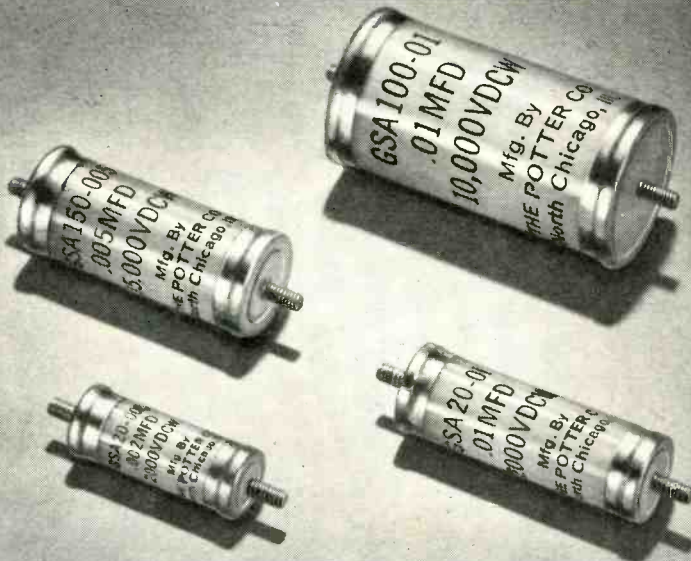

For High Voltage Applications:

TYPICAL APPLICATIONS:

- Low current power supply filters
- Oscilloscope, Geiger counter, electrometer circuits
- Electronic computers
- Audio coupling and bypass
- High temperature AC and DC circuits, etc.

CAPACITANCE: Standard $\pm 10\%$, available at $\pm 5\%$. Other tolerances available on request.

POWER FACTOR: At 60 cycles is approximately 0.9% at 20°C, approximately 0.5% at 85°C.

INSULATION RESISTANCE: 10,000 megohms per mfd. or 10,000 megohms whichever is lesser, measured at 20°C with 500 VDC applied.

TEST VOLTAGE: 1 minute at $1\frac{1}{2}$ times rated voltage at 25°C.

TEMPERATURE RANGE: Standard -60°C to +125°C.

IMPREGNANT: GSA capacitors are silicone impregnated and filled.

CASE: Metal ferrules are soldered to silver bands fused to each end of heavy walled glass tubes. The vacuum tight assembly is fungus proof.

Metal caps are embossed to insure a flush contact.

THE potter COMPANY

Specialists in Layer Wound Capacitors Since 1925
1950 SHERIDAN ROAD, NORTH CHICAGO, ILL.

NEW PRODUCTS

(continued)

spect to temperature is less than 0.02 percent per deg F. A leakage resistance in excess of 50,000 megohms and voltage breakdown exceeding 2,000 v are features which make the Isoply useful in special applications. Dimensions of the supply are $1\frac{1}{8}$ in. by $2\frac{1}{2}$ in. by $5\frac{1}{4}$ in. Circle 411 on Reader Service Card.

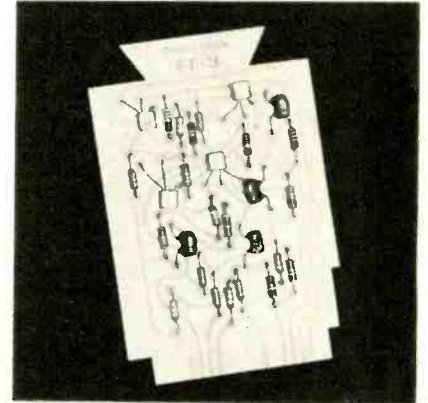

PLUG-IN CARD

for digital systems

COMPTON CORP., Belmont, Mass. The first of a new series of transistorized, printed circuit digital systems elements has been announced. Designated the FF-3, the unit is a flip-flop register which, with associated diode circuits, will gate clock triggers to a maximum of 10 similar flip-flop units without intervening power amplification. It is designed to operate from 0 to 200 kc (although operation up to 1 mc may be obtained on request) at temperatures up to 55°C. Input diode gates are included on this card to make the unit a more flexible computer element and simplify the external wiring. Circle 412 on Reader Service Card.

CERAMIC TETRODE

for single sideband

EITEL-MCCULLOUGH, INC., San Bruno, Calif., has announced a new high-current, low-voltage radial beam tetrode having high power gain and a plate dissipation of 1,000 watts.

Designated the 4CX1000A, this new tube type incorporates all the advantages of Eimac ceramic-metal construction and high-tem-

6 cps to 100,000 cps at
1,000 WATTS CONTINUOUS DUTY

...with
the new
Genisco-Savage
high-output
amplifiers!

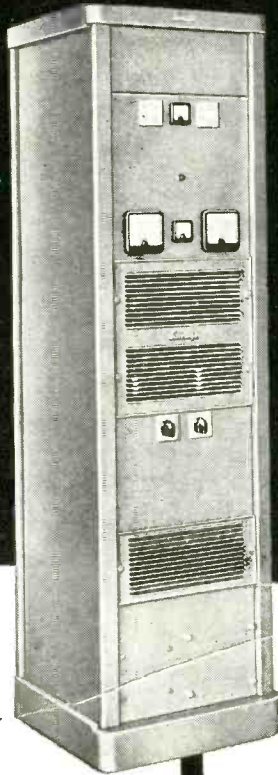

Seven models—rugged enough for production line testing; versatile enough for almost all laboratory needs.

Here's the new line of quality, high-output amplifiers you've been waiting for! All seven models feature high power output, low distortion, exceptionally high reliability and stability, and excellent output voltage waveform.

The Model KLF, shown at left, is particularly useful as an exciter for vibration testing equipment and as a variable frequency power supply for a multitude of production and laboratory needs. It will operate *continuously* with an output of 1,000 watts from 6 to 2,000 cps.

Components of all Genisco-Savage Amplifiers are mounted on 19" vertical panels to facilitate easy inspection and maintenance. Quick-release grill covers make all tubes readily accessible from the front. Numerous built-in safety features protect the equipment from operator errors.

Two New Shake Tables Available The new Model V1000 Genisco-Savage Shaker features a very light moving coil assembly, high thrust-to-weight ratio, automatic impedance matching, and an excellent output waveform. A continuous alternating thrust of ± 600 lbs. is produced at 1,000 watts control power. Thrust can be increased to ± 750 lbs. peak by use of a blower (Model V1000B). Both models have been stress-tested to withstand continuous operation at accelerations of 100 G's.



The Genisco-Savage Model V1000 Shaker

BRIEF SPECIFICATIONS	MODELS						
	BM2	DM2	KM2	10K	KM2S	KLF	KRF
Output	250 w at 50 or 100 v	500 w at 50 or 100 v	1000 w at 50 or 100 v	10,000 w maximum	1000 w at 50 or 100 v	1000 w at 50, 100, or 200 v	1000 w at 25, 50 or 100 v
Frequency Range	50 to 10,000 cps at 250 w	50 to 10,000 cps at 500 w	50 to 10,000 cps at 1000 w	40 to 10,000 cps at 10,000 w	50 to 10,000 cps at 1000 w	6 to 2000 cps at 1000 w	5 to 100 kc at 1000 w
Sensitivity	0.036 v at 600 ohms	0.04 v at 600 ohms	0.1 v at 600 ohms	0.16 v rms at 600 ohms for 10,000 w output	0.1 v at 600 ohms	0.05 v at 600 ohms	0.5 v at 600 ohms
Distortion	1% at 250 w, 1000 cps	0.75% at 500 w, 1000 cps	Less than 0.75% at 1 kw, 1000 cps	Less than 3% at 10 kw, 1000 cps	Less than 0.75% at 1 kw, 1000 cps	Less than 5% at 1 kw, 10 to 1000 cps	

Price and delivery of both amplifiers and shakers are exceptionally good. For complete specifications and prices send for the new four-page illustrated brochure.



Genisco, Incorporated
2233 Federal Avenue
Los Angeles 64, California

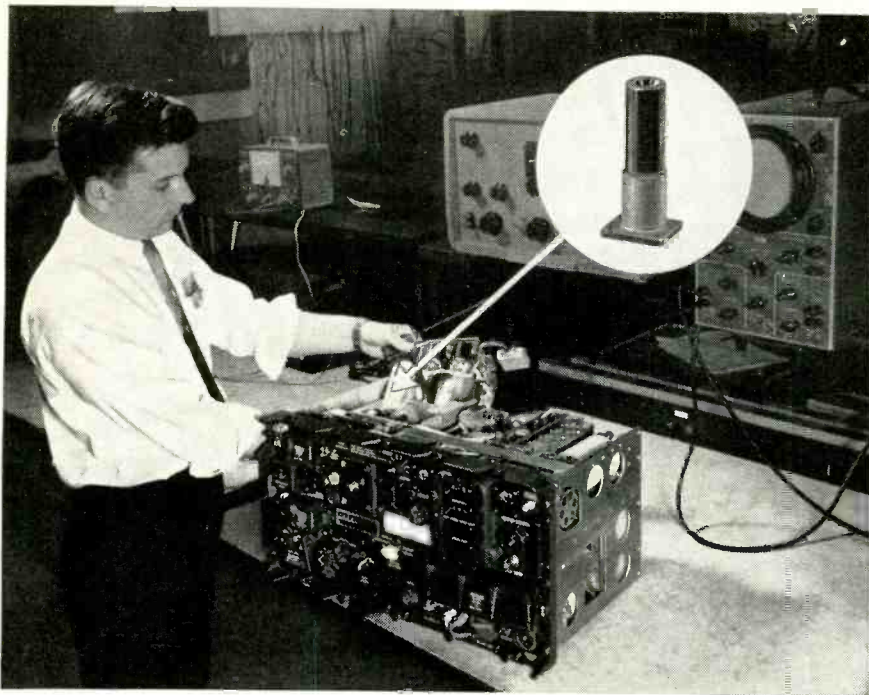

Unusual properties, including outstanding heat and impact resistance, make Ferrotron ideal as a load core in transmitting equipment.

FERROTRON®

... a new material for electronic design

● **POLYPENCO®** Ferrotron is an iron powder filled plastic material whose magnetic permeability and "Q" are essentially constant with frequency, time and temperature cycling. Its unusual properties, and availability as both a rigid and flexible material, create new possibilities in design or miniaturization.

FERROTRON has these desirable characteristics:

- Constant magnetic permeability and high "Q"
- Stable from -70°C to $+200^{\circ}\text{C}$
- Unaffected by exposure to high relative humidities
- High volume resistivity
- Extremely high impact strength

FERROTRON is available in two forms:

Rigid Cores: Rigid iron powder cores offer exceptionally high impact strength; are easily machined. Used for tuning cores, cup cores, loading cores, etc.

Flexible Tape and Rod: These are new shapes which combine the flexibility of paper, the ferromagnetism of powdered iron cores and the dielectric loss characteristics of plastics.

Write today for complete information on this new ferromagnetic material.

THE POLYMER CORPORATION OF PENNA.

Reading, Penna.

Export: Polypenco, Inc., Reading, Penna., U.S.A.

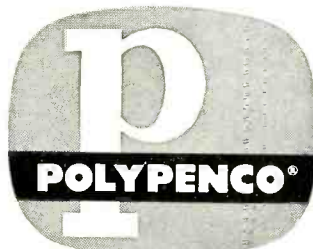

POLYPENCO Nylon, POLYPENCO Teflon†, FERROTRON and NYLATRON® GS

†DU PONT TRADEMARK

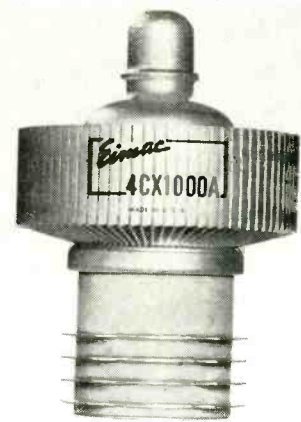

perature processing. Specifically designed for ssb operation, the 4CX1000A is a low-voltage, high-current Class AB, r-f or a-f linear amplifier tube, exhibiting high power gain and exceptionally low distortion characteristics. The 4CX1000A achieves its maximum rated output power with zero grid drive, thus minimizing driver stage design problems and eliminating one source of distortion. Circle 413 on Reader Service Card.



PLUG-IN MODULE for strain gage balance

NORTH ATLANTIC INDUSTRIES, INC., 603 Main St., Westbury, L. I., N. Y. A miniature, plug-in module, no larger than a lipstick case but containing complete circuitry for strain gage balance is now in production. It is the first of a series of repairable or expendable units which will provide space and weight-saving benefits to aircraft and missile electronic systems.

The strain gage balance module achieves precise calibration and adjustment through use of micro-miniature resistors and a miniature pot. The new circuit packaging concept permits shrinking both standard and special circuitry for other applications, incorporation

Introducing...
the world's
most compact
radiation-
cooled
high-power
**INDUSTRIAL
TRIODE**

...the new

**Amperex[®]
7092**

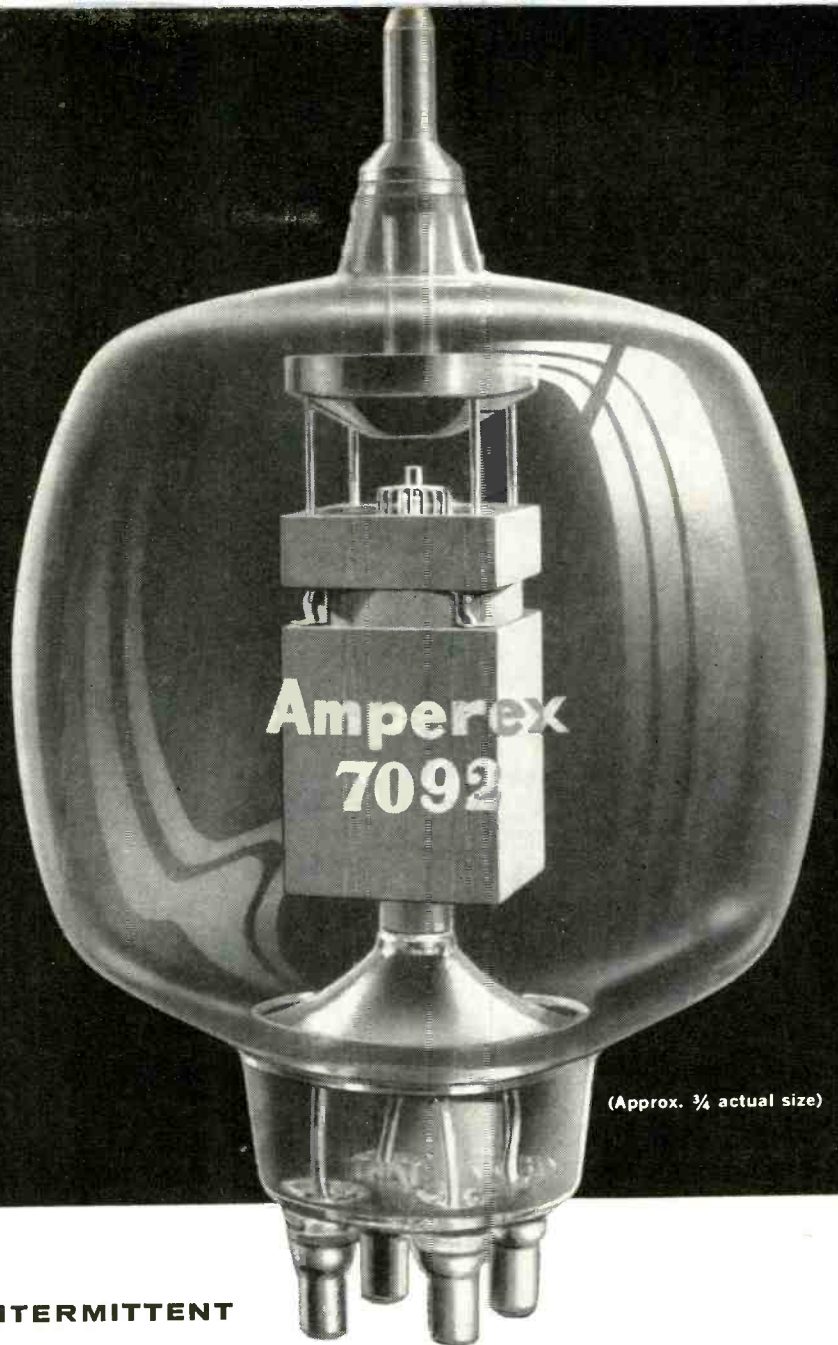

(Approx. 3/4 actual size)

2 KW CONTINUOUS, 3 KW INTERMITTENT

INTO INDUSTRIAL LOADS - CLASS C - WITHOUT WATER COOLING

**INDUSTRIAL OSCILLATOR, CLASS C
CONTINUOUS DUTY
SINGLE PHASE, RECTIFIED,
UNFILTERED PLATE SUPPLY**

Typical Operation (Per Tube)

Frequency	50	50	50	Mc
D.C. Plate Voltage	2700	3600	4500	Volts
D.C. Grid Voltage	270	325	360	Volts
Peak R.F. Grid Voltage	625	685	720	Volts
D.C. Plate Current (Full Load)	630	630	630	mA
D.C. Plate Current (No Load)	180	155	135	mA
D.C. Grid Current (Full Load)	180	160	145	mA
D.C. Grid Current (No Load)	305	270	250	mA
Grid Resistor	1500	2000	2500	Ohms
Driving Power (Approx.)	125	123	115	Watts
Plate Load Impedance	2250	3000	3800	Ohms
Plate Dissipation*	540	640	780	Watts
Plate Input	2100	2800	3500	Watts
Tube Plate Output	1560	2160	2720	Watts
Tube Efficiency	74	77	78	Percent

*For 50% duty cycle, averaging time 10 seconds, plate dissipation may be increased 50%.

- extra-thick hard-glass envelope for exceptional ruggedness and temperature resistance
- thoroughly dependable service in ultrasonics, induction and dielectric heating at a 40% saving in tube and accessory costs
- thoriated-tungsten filament—6.3 volts, 32.5 amps
- available from stock



ask **Amperex**

...about new tubes for

high-power industrial applications

Further details available from Industrial Tube Division

AMPEREX ELECTRONIC CORP., 230 DUFFY AVENUE, HICKSVILLE, L.I., N.Y.

In Canada: Rogers Electronic Tubes & Components, 11-19 Brentcliffe Road, Leaside, Toronto 17.

IERC Heat-dissipating "plug-in" Tube Shields for Printed Circuits!

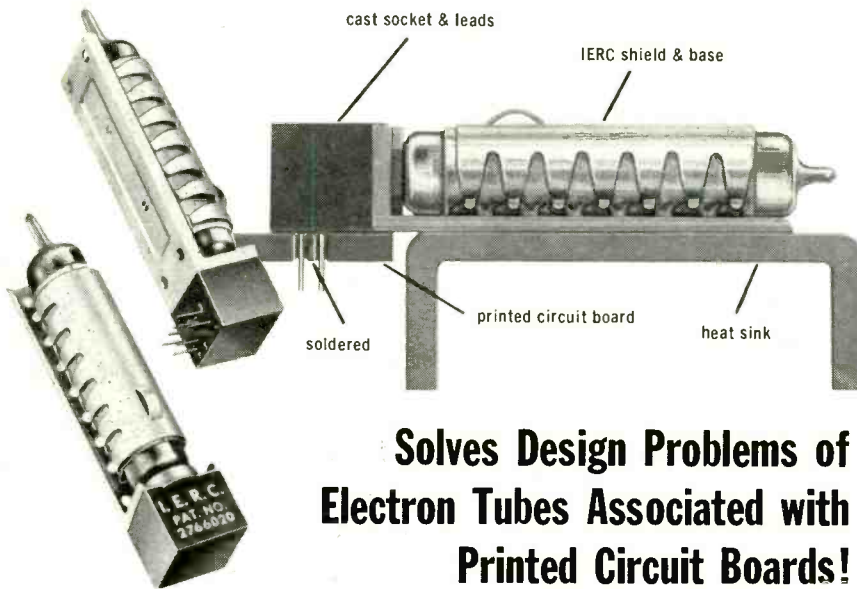

Solves Design Problems of Electron Tubes Associated with Printed Circuit Boards!

IERC's latest heat-dissipating tube shields for round button and flat press subminiature electron tubes solve design and performance problems of tubes associated with printed circuit boards. Standard socket and an Epoxy resin are integrally cast to the shield base. Socket leads extend from the Epoxy casting 90° to plane of base permitting direct plug-in to printed circuits for hand or dip-soldering of connections. Bulb temperatures are maintained to within 5°C of the heat sink temperature per watt of heat-dissipation when shields are attached, as suggested, to a heat sink of proper thickness for conduction or hollow duct types permitting air or liquid circulation. IERC's patented design provides maximum cooling, excellent tube retention, shock and vibration protection under severe conditions. Pertinent dimensions are to .1 inch grid layout.

Patented and Patents Pending



Heat-dissipating electron tube shields for miniature, subminiature octal and power tubes

International

electronic research corporation

145 West Magnolia Boulevard, Burbank, California

IERC Research and Engineering experience on improving electron tube life and reliability has won industry-wide acceptance and established IERC as *the Authority* for the best answers to your tube failure problems. Write today for free information on IERC tube shields—the *only complete line available* for new equipment and retrofitting programs.

of miniature amplifiers, cathode followers, pulse circuits and others employing transistors or subminiature vacuum tubes.

Modules of the P-500 series are available in a range of sizes, with light but rigid metal cases which can be color-coded. Equipped with male or female miniature connectors in one or both ends, they can be inserted directly in the line or used in tandem in appropriate combinations.

Current modules were designed for operation at ambient temperatures up to 125 C, altitudes up to 60,000 ft. Units are produced in ruggedized commercial form and to military specifications. **Circle 414 on Reader Service Card.**



SPECTRUM ANALYZER wide-dispersion type

POLARAD ELECTRONICS CORP., 43-20 34th St., Long Island City 1, N. Y., announces the model TSA-W spectrum analyzer. This unit was developed to provide even greater frequency dispersion than that provided by the model TSA spectrum analyzer for the analysis of narrow and wide pulsed signals. The maximum dispersion of this new spectrum analyzer has been widened so that it now covers 100 kc (with a 7-kc resolution) to 70 mc (with a 50-kc resolution). A new marker has been provided with a range of 80 mc and employs a vernier control for measurements of small frequency differences.

A pulse width scale calibrated in μ sec has been added to the marker. Another new feature is a logarithmic display in addition to

Multi-track magnetic recording reproducing heads . . .

Laboratory-designed, precision-built by Davies

Series	Track Data		Crosstalk (db)	Number of Tracks for Various Tape Widths									
	Width (Mils)	Spacing C to C (Mils)		¼	½	¾	1	1¼	1½	1¾	2		
700	50	140	-60*	2	4	5	7	9	11	13	14		
800	40	125	-60*	2	4	6	8	10	12	14	16		
1000	40	100	-55*	3	5	8	10	13	15	18	20		
1200	32	85	-50*	3	6	9	12	15	18	21	24		
1300	26	78	-40**	3	6	10	13	16	19	23	26		
1400	40	72	-40**	3	7	10	14	17	21	24	28		
S1400	32	70	-40**	3	7	10	14	17	21	24	28		
1600	32	62	-35**	4	8	12	16	20	24	28	32		
2000	20	50	-35**	5	10	15	20	25	30	35	40		

*For Direct Recording, 1000cps
**For Digital Pulse Recording

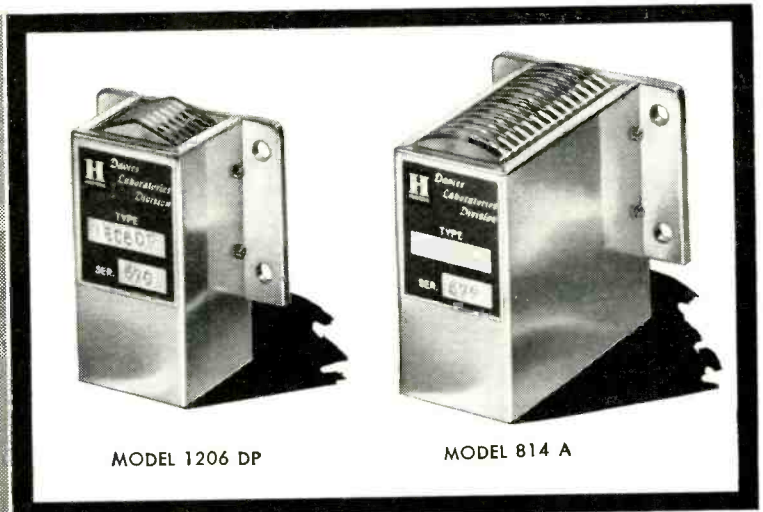

MODEL 1206 DP

MODEL 814 A

Davies multi-track recording and reproducing heads for magnetic tape data recording are offered in a wide selection of designs for every practical tape service.

Davies single-stack heads are precisely aligned for those applications requiring coincidence of time and phase among tracks. Gap alignment is held to within ± 0.1 mil per inch of tape width.

For services requiring a large number of tracks, but where time and phase displacement can be tolerated, Davies 700, 800 and 1000 Series Heads can be interleaved to provide 14, 16, or 20 tracks on 1" tape.

All-metal tape contact area on Models with the "P" designation (1206 DP above) essentially eliminate oxide build-up at high tape speeds.

In all types, plastic encapsulation protects and preserves the characteristics, even under adverse environmental conditions such as shock, vibration and extremes of temperature and humidity.

Select the appropriate recording/reproducing head from the condensed chart. Complete technical and application information may be obtained by writing Minneapolis-Honeywell Regulator Co., Davies Laboratories Division, 10721 Hanna Street, Beltsville, Md.

Honeywell



DAVIES LABORATORIES DIVISION

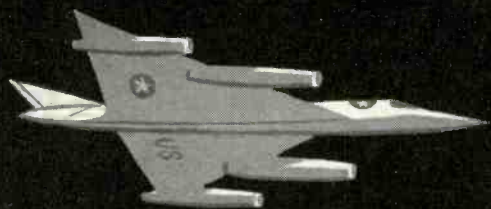

new from
CHICAGO STANDARD

HERMETICALLY SEALED
400 CYCLE
TRANSFORMERS

IN
MILITARY STANDARD
CASES

in stock for
immediate delivery

POWER TRANSFORMERS—TF4SX03* (plate and filament)

FILTER REACTORS—TF4SX03*

FILAMENT TRANSFORMERS—TF4SX01*

These transformers are designed and built in accordance with MIL-T-27A, Grade 4, Class S (85°C. ambient, 45°C. rise), operating temperature and life expectancy X (10,000 hours, minimum). Maximum operating altitude 70,000 feet. Schematics permanently silk-screened on one-piece drawn steel case.

For complete details on these new stock transformers write for the new Chicago Catalog CT3-57.

* (indicate letter designations that vary with case size.)

CHICAGO STANDARD TRANSFORMER CORPORATION

3502 Addison Street • Chicago 18, Illinois
Export Sales: Roburn Agencies, Inc. 431 Greenwich St., New York 13, N.Y.



the linear display. This effectively increases the dynamic range of the instrument and permits detailed examination of minor lobes.

The broad frequency range of the TSA-W spectrum analyzer is the same as the other spectrum analyzers in the Polarad line and utilizes interchangeable plug-in heads to cover the frequency range of 10 mc to 44 kmc.

A specification sheet is available for further detailed technical information. Circle 415 on Reader Service Card.

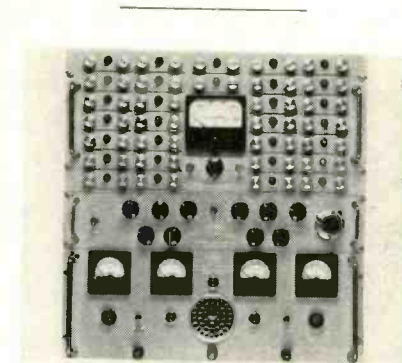

DECOMMULATOR

27-channel system

ARNOUX CORP., 11924 West Washington Blvd., Los Angeles 66, Calif. Designed for use in airborne or trailer installed telemeter receiving stations and in portable ground checkout equipment, this new 27-channel decommuration system occupies only 19½ in. of panel height in a standard relay rack. Overall depth is 13 in.

Model TDS30-1 decommuration system is completely self-contained within three chassis assemblies consisting of: gating unit (top), pulse selector (middle) and regulated power supply (bottom). Modular plug-in gating units allow quick replacement of faulty channels. Miniaturization is made possible through a unique design requiring only 76 vacuum tubes, as opposed to hundreds in comparable systems of conventional design. The system accepts all standard RDB inputs, either PAM or PDM, at any repetition rate from 2½ to 40 rps.

Either single ended or push pull input signals are accepted. Outputs may be operated single or double ended. Overall linearity is

Varian Strip Chart Recorders

POTENTIOMETER PERFORMANCE* AT MODERATE COST

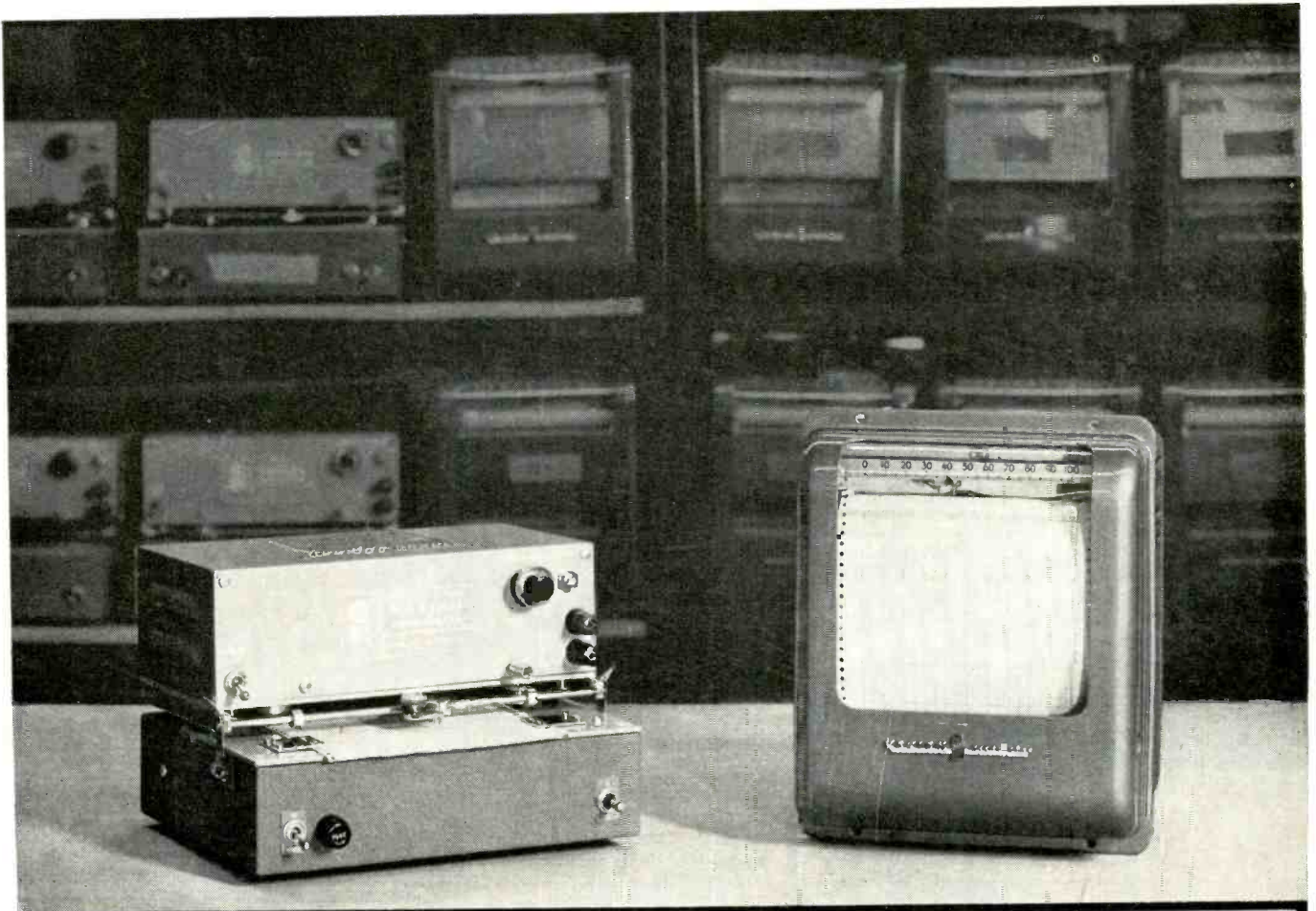

Varian G-10 — Portable for laboratory or bench use where chart accessibility is of prime importance. Base price \$340.

Varian G-11 — For panel, rack or portable use; designed for OEM, lab or field for long-term monitoring. Base price \$450.

* The servo-balance potentiometer method has long been used in expensive recorders to achieve superior stability, sensitivity, ruggedness and high input impedance. Use of servo balancing systems assures full realization of these inherent advantages by providing ample power independent of the source being measured. Now Varian offers you recorders of moderate cost using this time-proven principle.

VARIAN SPECIFICATIONS:

- Spans as low as 10 mv
- Limit of error 1%
- Maximum source resistance 50K ohms or higher
- Balancing times: 1 second or 2.5 seconds on G-10; 1 second on G-11

WRITE TODAY FOR COMPLETE SPECIFICATIONS

Varian recorders are sold and serviced throughout the free world by representatives in principal cities.



PALO ALTO 4, CALIFORNIA

Varian Associates manufactures Klystrons, Traveling Wave Tubes, Backward Wave Oscillators, Linear Accelerators, Microwave System Components, R. F. Spectrometers, Magnets, Magnetometers, Stalos, Power Amplifiers and Graphic Recorders and offers research and development services.

INDIUM

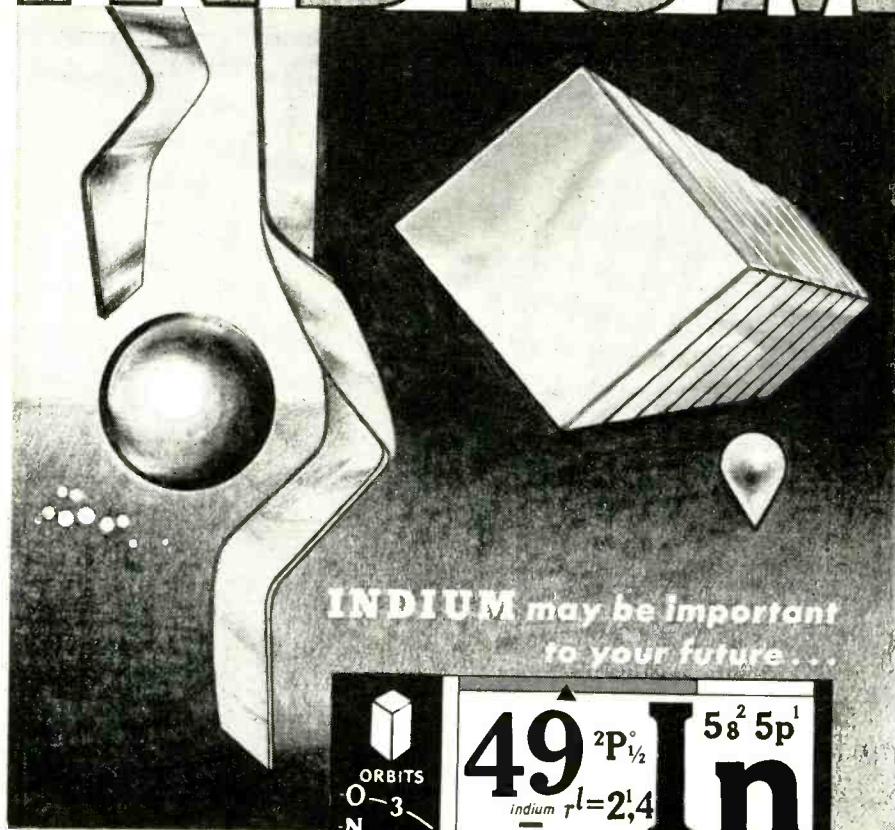

INDIUM may be important
to your future . . .

Metallurgists and engineers in many industries are making startling advances through use of INDIUM in one or more of its various commercial forms. Even we can't begin to imagine the rapidly expanding range of applications.

You may have a product development problem for which INDIUM might be the answer. Why not write us and investigate the possibilities?

COMMERCIAL QUANTITIES AVAILABLE:

- Indium metal (specially refined 99.999% pure)
- Indium metal (99.97% pure)
- Indium wire
- Indium foil and ribbon
- "Indalloy" intermediate solders
- Indium pellets
- Indium spheres
- Indium powders
- Other high-purity metals

Write Dept. E-11 for new INDIUM bulletin:
"Indalloy" intermediate solders

QUALITY

at the Indium Corporation of America means: purity of metals, and strict adherence to specifications.

SERVICE

means prompt delivery to customers, and technical help in specific uses of INDIUM.

RESEARCH

means "forward looking" with respect to new products and new techniques.

THE **INDIUM** CORPORATION OF AMERICA

1676 LINCOLN AVENUE UTICA, NEW YORK

Since 1934 . . . Pioneers in the Development and Applications of Indium for Industry.

within $\pm\frac{1}{2}$ percent at maximum signal level. Long term level drift is within ± 2 percent and gain drift is negligible. Circle 416 on Reader Service Card.



LOBING SWITCH

small, lightweight

CADO MFG. Co., 1646 18th St., Santa Monica, Calif., has developed a small, lightweight lobing switch for lobing frequencies from 20 to 100 cps. Weighing less than 30 oz. and standing 3 in. high by 5 in. long, the new lober was developed to fill a long-standing need for a small switch to meet the requirements of MIL-E-5272-A. It maintains a vswr of less than 1.3 to 1 to 1,300 mc, while operating with a minimum crosstalk reading of 40 db and 1,000 hours life. Circle 417 on Reader Service Card.



PHOTOTUBE

with electron multiplier

RADIO CORP. OF AMERICA, Harrison, N. J. The 7046 is a 14-stage, head-on, multiplier phototube having a $4\frac{1}{8}$ in. diameter photocathode

for applications demanding **DEPENDABLE INSULATIONS**

Specify...

ESSEX
EXTRA TEST® **MAGNET**
WIRE

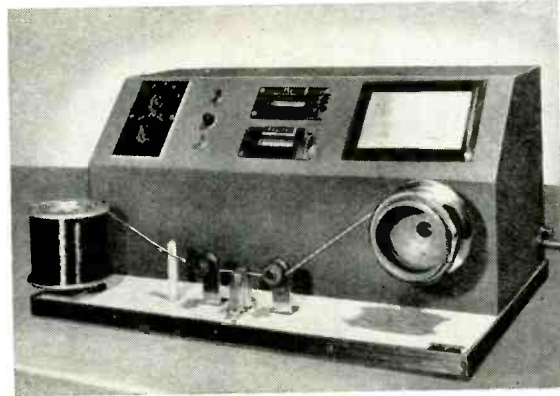

*Quality controlled by tests
exceeding accepted standards*

Consistently trouble-free performance characterizes the use of Essex Extra Test Magnet Wire. It stems from close quality control maintained at every step in fabrication. Illustrated above is one example... the continuity test used for measuring breaks in insulation. By this, and similar controls, does Essex produce Magnet Wire to the industry's most severe specifications. Essex only makes one quality... and that's Extra Test. It costs no more to *be sure* by using SX.

APPLICATION...

Essex Extra Test Magnet Wire will save downtime... speed operations in your winding department. It has superior windability... maximum dielectric strength... and uniformity of size from spool-to-spool. Winds compactly at high speeds and around sharp radii.

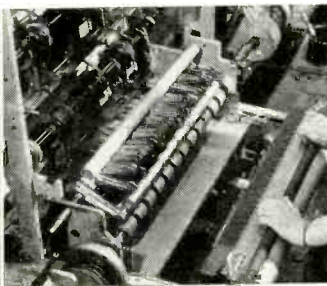

PACKAGING...

Essex Extra Test Magnet Wire is available in Metal or Fiber containers (MAGNA-PAK®) or in commercial reel or spool put ups. Distinctive labeling assures fast, accurate identification. MAGNA-PAK containers are palletized for shipment; simplifying storage.



EXTRA TEST®
ESSEX MAGNET WIRE

DIVISION ESSEX WIRE CORPORATION, Fort Wayne 6, Indiana

MANUFACTURING PLANTS — Birmingham, Alabama; Anaheim, California; Fort Wayne, Indiana; Detroit, Michigan.

SALES OFFICES AND WAREHOUSES*

*Birmingham, Ala.
*Chicago, Illinois
Cleveland, Ohio
Dallas, Texas
Dayton, Ohio
Detroit, Michigan
Fort Wayne, Indiana

Fort Worth, Texas
Hartford, Conn.
Indianapolis, Ind.
Kansas City, Mo.
*Los Angeles, Calif.
Milwaukee, Wisc.
*Newark, N. J.

*Portland, Oregon
Rochester, New York
*Saint Louis, Mo.
*San Francisco, Calif.
Upper Darby
(Philadelphia), Pa.

Distributed nationally to the repair and maintenance industry through Insulation and Wires, Incorporated

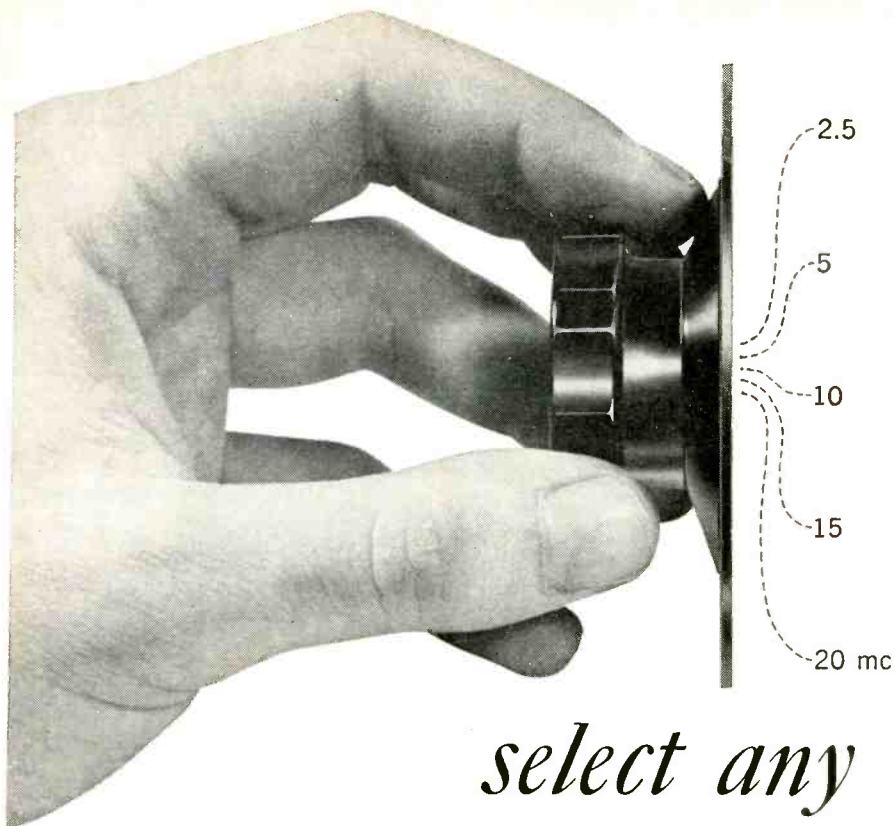

*select any
WWV-WVH
 signal with the
 click of a switch!*

MODEL WWVC FREQUENCY COMPARATOR ENDS "SEARCHING" FOR THE STRONGEST STANDARD SIGNAL

This new tool can save you valuable calibration time. With it you can quickly find the strongest signal available at any moment from the National Bureau of Standards — *without searching*.

A five-position dial switches precisely to any standard frequency — 2.5, 5, 10, 15 or 20 MC — each crystal controlled. Built-in oscilloscope and speaker make measurements easy. Model WWVC includes comparator function selector, Collins plug-in filter for high selectivity, automatic gain and volume controls, and adjustable threshold control which eliminates noise and other modulation in tick position.

Calibrate any frequency accurately and quickly with the Model WWVC.

Write for Bulletin C-1.

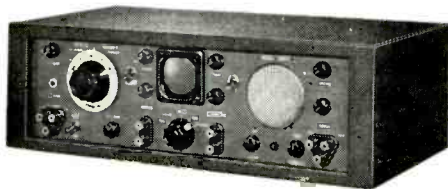

MODEL WWVC *standard frequency comparator*



SPECIFIC PRODUCTS

p. o. box 425; 21051 Costanso, Woodland Hills, California

and featuring very good electron-collection efficiency, very small spread in electron-transit time, very short time-resolution capability, relative freedom from after-pulses and high current gain. These features make the 7046 especially useful in nuclear radiation measurements.

Utilizing a semitransparent photocathode on the curved inner surface of an ultraviolet-transmitting-glass faceplate, the 7046 has a spectral response covering the range from about 2,500 to 6,500 angstroms. Maximum response occurs in the blue region at approximately 4,200 angstroms.

The faceplate has a flat external surface which facilitates mounting of flat phosphor crystals in direct contact with the surface. Circle 418 on Reader Service Card.

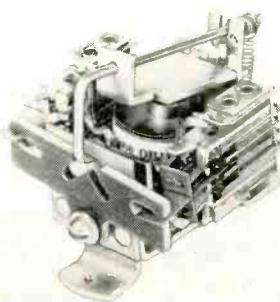

LATCHING RELAY alternate pulse type

POTTER & BRUMFIELD, INC., Princeton, Ind. A new single coil latching relay that selects alternate circuits or alternate circuit modes on successive impulses has been announced. Designated the PC, the relay employs an armature driven rocker type actuator to transfer one, two, three or four dpdt snap switches.

Gold flashed silver cadmium oxide contacts are rated at 10 amperes, 115 v a-c resistive. The relay can be operated from a-c or d-c sources and provides positive transfer on a single 30 millisecond impulse. The spring action of the contact arms effectively latches the relay in the transferred position when coil power is removed.

The PC was designed primarily for on-off and reversing features. It is used for remote tv controls, garage door openers, flow control



How would
you like
your **SHIFT REGISTERS?**

Whatever your requirements relating to buffer storage, pulse distribution or other pulse, digital and logic functions, we would like to talk to you about them. Epsco designs a wide variety of transistorized, transistor-driven and tube-driven shift registers and magnetic logic elements, featuring high reliability, low-power consumption and compactness . . . and manufactures them in volume right to the letter of each individual specification.

Custom engineering-production of electronic components (shift registers, magnetic logic elements, delay lines, special pulse transformers, etc.) is our specialty. You can count on the cooperation of Epsco's engineering staff and field representatives for effective, economical fulfillment of your performance requirements and for conscientious service right down the line. Your inquiry will receive prompt action. Write for Shift Register technical bulletin.

Epsco, Incorporated, Dept. R-107, 108 Cummington St., Boston 15, Mass.

START-TO-FINISH cooperation
... an Epsco guarantee

Epsco 
COMPONENTS

SALIENT FEATURES OF EPSCO SHIFT REGISTERS

- Standard packaging—9-pin miniature base, dip-solder terminals for printed circuits, and solder-lug panel with mounting ears; standard epoxy and hermetically sealed cases, or custom packaging to your specifications.
- Minimum size—below $\frac{1}{4}$ cu. in. per binary digit.
- Surpass applicable MIL specification.
- Extremely low power consumption—less than 0.25 watt peak power for 3kc rate; 0.6 watt peak power for 100 kc rate.
- Wide operating tolerances; dependable field performance.

Insure Product Performance...

REVERE SPECIALTY WIRES

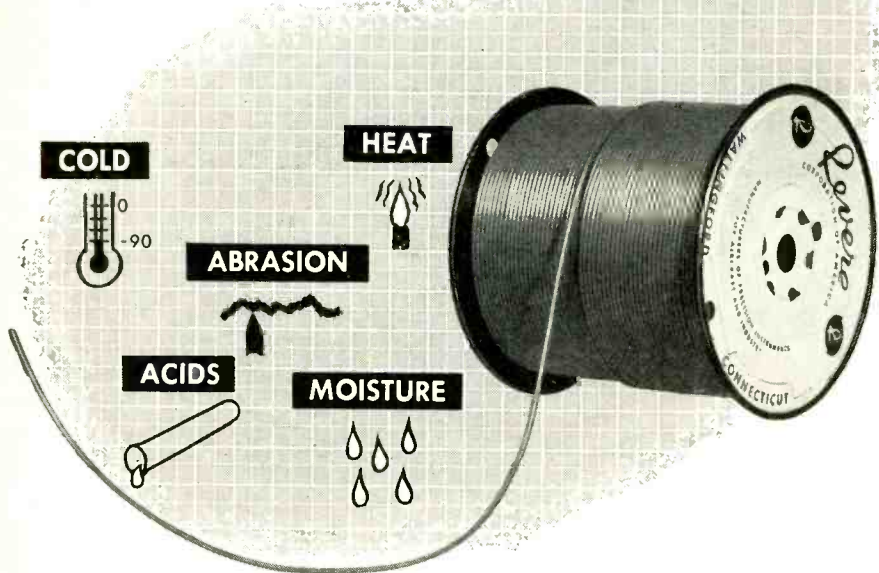

For those tough design jobs where ordinary hook-up and thermocouple wires die from the heat, get brittle in cold, abrade and corrode . . . Revere SPECIALTY wires stand up. Built to MIL and customer specifications. Range includes:

For High Temperatures

REVCOTHENE — (Extruded Monochlorotrifluoroethylene) —40°F to +275°F, AWG 28 to 10, silver-plated copper conductors, inert, excellent dielectric strength, no volatile plasticizers, non-flammable, thin wall, abrasion and moisture resistant.

PERMACODE — Teflon* — insulated wire with striping down to the conductor for permanent identification, single or multiple stripes, 15 colors, -130°F to +410°F, AWG 28 to 16, silver-plated copper conductors, excellent abrasion and dielectric characteristics.

A variety of telemetering and other multi-conductor cables constructed to customer specifications. Teflon, polyethylene, polyvinyl, nylon, glass, Revcothene, asbestos insulations for singles and jackets. Twisting, braiding, shielding, color coding to suit conditions.

Iron-constantan, copper-constantan, Chromel-Alumel conductors, AWG 36 to 14, various insulation combinations and protective braids, temperature range from -100°F to +1500°F, constructed to rigid tolerances.

*E. I. du Pont trademark

Saturants for flame and abrasion resistance, metallic braids for severe service and electrical shielding. Color coding in 15 solid colors and stripes.

Prompt delivery of standard stock wires. Write for samples and literature on specialty hook-up or thermocouple wire.

20

REVERE CORPORATION OF AMERICA

Wallingford, Connecticut

A SUBSIDIARY OF NEPTUNE METER COMPANY

neptune

NEW PRODUCTS

(continued)

motors and other applications requiring a low cost means for a transferring between alternate circuits at undefined periods. Circle 419 on Reader Service Card.

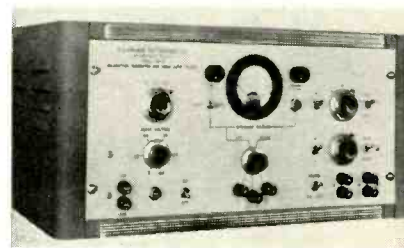

ANALYZER

for unijunction transistors

POLYPHASE INSTRUMENT Co., East Fourth St., Bridgeport, Montgomery Co., Pa. The TA-10 unijunction transistor and diode checker traces on an oscilloscope the negative resistance or emitter characteristic curves of the GE type ZJ14 unijunction transistor (double-based diode type). Interbase and emitter voltages are metered and adjustable by front panel controls.

Semiconductor diode checking of all types of diodes is readily performed by oscilloscope display of forward and reverse current characteristic curves. Go, no-go type quality control and production checking procedures are easily set up.

A transistor circuit power supply is automatically provided because of the instrument's power supplies rated at 100 v, 100 ma. Circle 420 on Reader Service Card.

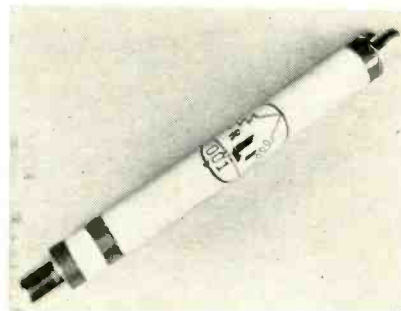

CERAMIC TUBE

for h-v switching

RESITRON LABORATORIES, INC., 2908 Nebraska, Santa Monica, Calif.,



**NEW HUGHES
ELECTRONICS
FACILITY SEEKS
QUALIFIED
ENGINEERS**

Exclusive new Hughes developments such as three-dimensional radar systems and high-speed data processing systems promise to place Hughes foremost in the field of advanced electronics. For the purpose of furthering these exclusive developments, Hughes is establishing a new facility at Fullerton, California.

This newest facility of the Hughes Aircraft Company will be a completely integrated organization. It will encompass all activities . . . from development through manufacturing and Field Engineering. This growth presents a wide range of opportunity for present and prospective employees.

The new Ground Systems Division will focus its attention on complex electronic and electro-mechanical systems for ground and shipborne applications. These systems will be produced for the military and promise great commercial potential.

Engineers with experience in microwave, circuit design and systems design should apply by writing to the address below.

the West's leader in advanced electronics

HUGHES

GROUND SYSTEMS DIVISION

Personnel Selection and Placement
HUGHES AIRCRAFT COMPANY
Fullerton, Orange County, California

PRECISION PRODUCTION PROBLEMS ?



NEW! ALIGNMENT INTERFEROMETER

Accurately measures small changes in angle over a range of 30 seconds of arc (± 15 seconds). Easy direct scale readings to 0.2 seconds (0.00006").



BENCH COMPARATOR

Exclusive under-stage illumination—no complex set-ups, no holding fixtures for most work. Magnified silhouettes show errors instantly. Reads to 0.0001" with optional micrometer stage.



CONTOUR MEASURING PROJECTOR

Shows magnified silhouettes or surface views. Simple operation, highest precision measurements: to 0.0001", linear; to 1 minute of arc, angular.



NEW TOOLMAKER'S MEASURING MICROSCOPE

Quickly measures opaque or transparent objects of any contour. Linear, accurate to 0.0001"; angular, to 1 minute of arc.

Here's help from
Bausch & Lomb

**TOOL DESIGN
INSPECTION
In FABRICATION
MEASURING
TESTING**

STEREO-MICROSCOPES

Magnified 3-D views of tiny parts. Dust-proof, shockproof, can be mounted right in machine or fixture. Speeds assembly, inspection. Most complete line, widest field of view.

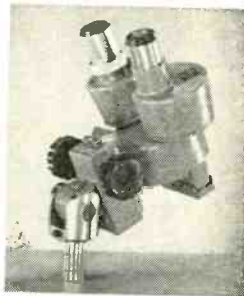

OPTICAL AIDS CATALOG

Time-and-money-saving data on Surface Comparators, Industrial Magnifiers, Microscopes, Microscope Bodies, Micrometer Discs, Wide Field Tubes, Brinell Microscopes, Shop Microscopes.

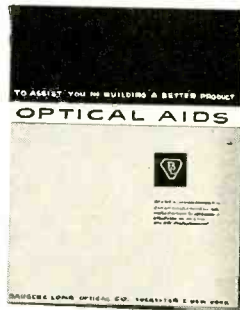

MAIL COUPON TODAY FOR VALUABLE DATA

BAUSCH & LOMB OPTICAL CO.
61423 St. Paul St., Rochester 2, N. Y.

Please send literature on optical production aids checked below:

- Alignment Interferometer Bench Comparator
 Contour Measuring Projector
 Toolmaker's Microscope Stereomicroscopes
 Optical Aids Catalog

NAME.....
TITLE.....
COMPANY.....
ADDRESS.....
CITY.....ZONE.....STATE.....

has available the RL-C30 ceramic high voltage relay for use where extreme mechanical shock and vibration are encountered. It is designed for h-v switching applications as in pulse-forming networks, antenna systems and switching in explosive atmospheres.

The unit is constructed for partial oil immersion and will stand off 30 kv d-c at 500 amperes pulse current.

The ceramic envelope of the relay is highly evacuated making it unaffected by ambient atmospheric conditions. This unit is capable of withstanding a temperature excursion ranging from -70 deg C to -300 deg. C. Circle 421 on Reader Service Card.

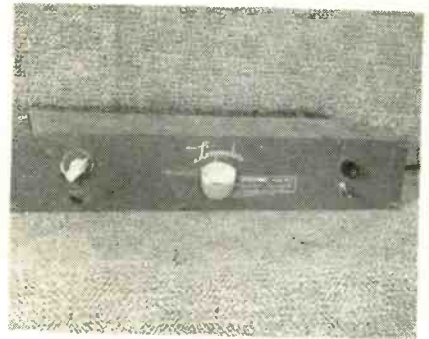

AGC AMPLIFIER

high-speed, nonfeedback

ELECTRONIC SYSTEMS ENGINEERING Co., 903 Cravens Building, Oklahoma City, Oklahoma. Model LE-3 Limpander (limiter-expander) is a new high-speed nonfeedback, automatic audio gain control amplifier with background noise squelching system. A low impedance input preamplifier provides sufficient gain to produce 30 db of low distortion limiting. High speed squelching operates between words without syllable clipping. Limiter attack time constant of 50 μ sec and release time constant of 20 millisecc produces consonant amplification for high intelligibility in recording and communication applications. It is a new tool for speech analysis and voice control communications systems.

The Limpander, Model LE-3 is especially designed to function as an agc system for tape recorders. It is particularly suited for re-

BAUSCH & LOMB



WHITE ALICE

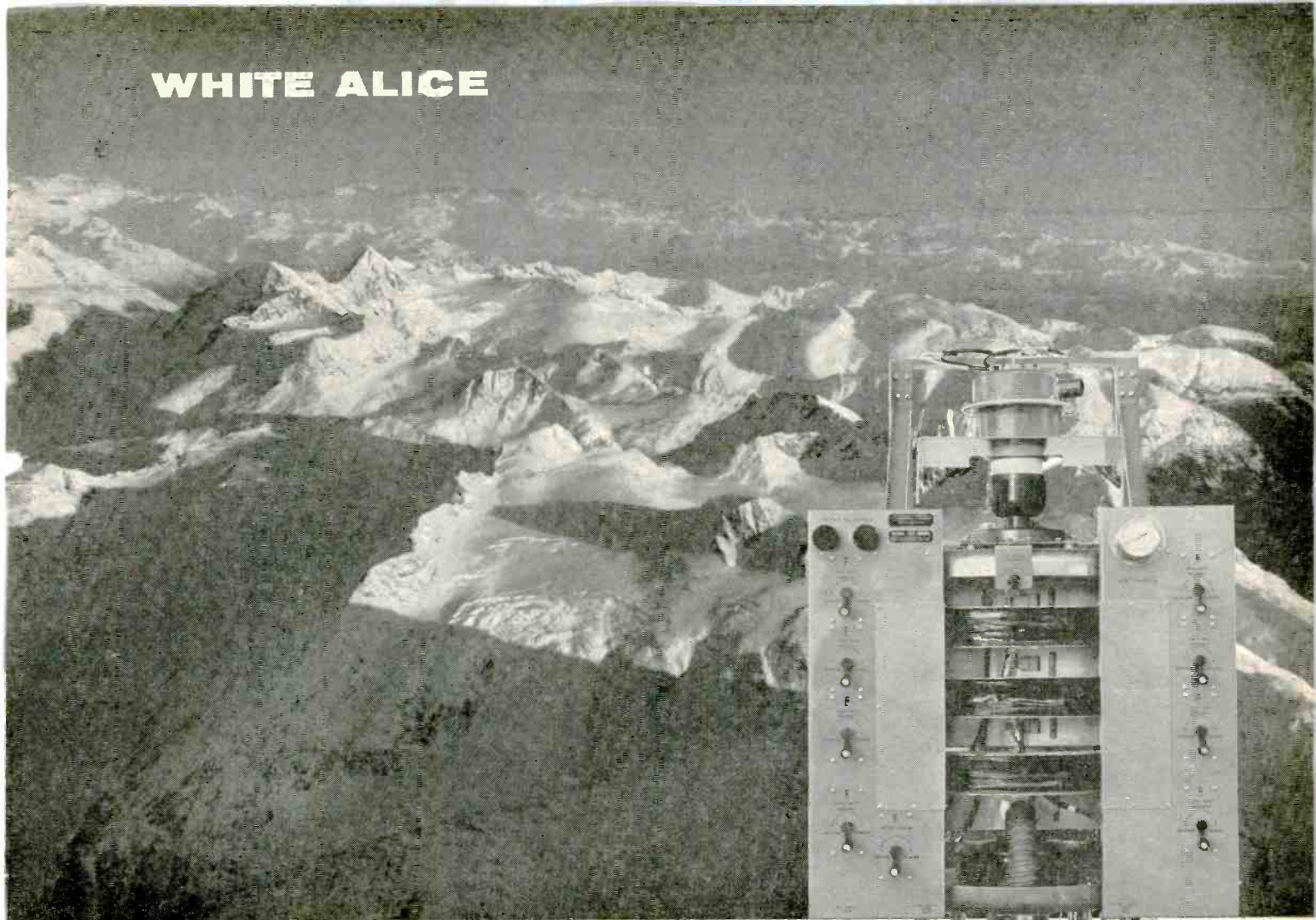

Another series on the extensive use of Eimac Klystrons in tropospheric communication systems

Eimac one and ten kw klystrons power Alaska tropospheric communication system

In the minds of the engineers and construction men who fought Alaska's frozen terrain, "White Alice" was no lady. Linking 33 far-flung communities, "White Alice" will have 3000 miles of communications upon completion. Up to 132 channels are provided over this route thanks to a combination of point-to-point microwave and scatter communication systems.

For tubes to power the "White Alice" one and ten kw installations, engineers turned to Eimac klystrons. The success of Eimac tubes in the other tropo-scatter networks made it easy for the engineers to make such a decision. Today, Alaska speaks . . . a feat made possible

by tropospheric communications powered by Eimac klystrons that "can take it."

Designers of electronic equipment are finding out more and more that Eimac has the answer to their tube problems regardless of what such problems involve. An inquiry to our Application Engineering Department will bring fast, informative information.

Type 799WA 10 Kw Klystron Amplifier
Designed and Manufactured for Western Electric Co. by Radio Engineering Laboratories, Inc

EITEL-McCULLOUGH, INC.
SAN BRUNO · CALIFORNIA

Eimac First for klystrons for tropospheric communications



	3K3000LQ				4K50,000LQ		
DC Beam Volts	8000	Power Output Watts	2000	DC Beam Volts	16,000	Power Output Watts	11,000
DC Beam Amps	0.57	Collector Dissipation	3000	DC Beam Amps	1.6	Collector Dissipation	50,000
Driving Power Watts	4.0	Power Gain	25 db	Driving Power Watts	0.10	Power Gain	50 db
	Efficiency = 45%				Efficiency = 43%		

IF YOU DESIGN

SPEED CHANGERS • DIFFERENTIAL DRIVES

COMPUTERS

MULTIPLE SERVO DRIVES • ADVERTISING DISPLAYS

DRIVES REQUIRING POSITIVE CLUTCHING

save money with

HYCOR

precisioneered

miniature
magnetic
clutches



The HYCOR line offers new design opportunities for low-cost single or multiple clutching in electronic equipment. Check these outstanding features:

- only 1/10th the usual cost
- 2 watts of power develop up to 15 oz. in. of torque with a response time of 5 milliseconds
- zero clutch slip within rated operating conditions
- no maintenance—only 2 moving parts
- extra compact and lightweight
- 9 models available for gear, cable and direct-in-line drives. Also in multi-shaft drive units

Write for Bulletin C-2 . . . or discuss your applications with a HYCOR systems engineer.



INTERNATIONAL RESISTANCE COMPANY

HYCOR DIVISION
12970 Bradley Ave., Sylmar, California

ording unrehearsed conversations and conferences where it is impractical to use conventional gain monitoring techniques. The 600 ohm output has sufficient power to drive a speaker directly. One Limpander can serve for limiting on recording, and limiting or expanding on playback. Noise suppression capabilities make 60 db of automatic audio control practical. Circle 422 on Reader Service Card.

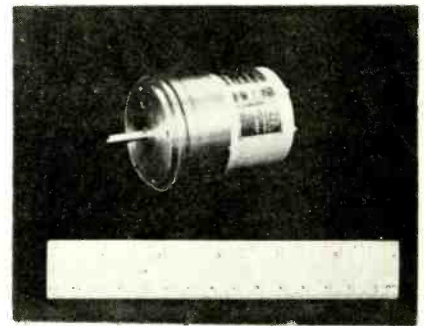

TRANSFORMER

with low output impedance

PERKIN-ELMER CORP., Norwalk, Conn. A new type of Vernistat variable ratio computing transformer with an open circuit linearity of ± 0.1 percent has been developed. Model 20-C can provide a substantial power output—sufficient in many instances to eliminate power amplifiers. Applications of the new transformer include its use in analog computers where the product of a voltage and a shaft angle is required, in the control of two-phase servo motors, and in the supply of power to torque motors.

At an input of 115 v, 400 cps, the output voltage range of the model 20-C is ± 80 v. Due to its low output impedance, a linearity of ± 0.35 percent is obtained with a 1,000-ohm load. With a 2,000-ohm load, the linearity is ± 0.18 percent. Under maximum load conditions, the quadrature component of output is approximately 5 mv per v of the primary excitation voltage. Basic resolution, resulting from 800 equivalent turns of wire, is 0.13 percent, and interpolation by a resistive brush permits the shaft to be adjusted to obtain any required value of output volt-

IRC[®]

BREAKS THROUGH the reliability barrier

As jet planes and missiles leave old barriers behind, electronic components find ever-tougher barriers of reliability ahead of them. Those designed for yesterday are already obsolete, those designed for today will soon be. But IRC resistors are ready now to leap ahead of tomorrow's new barriers. Designed ahead of their time, they are also produced by "ahead of their time" processes and quality control techniques. This pattern of progress makes IRC reliability a standard unto itself—a standard that is yours on the widest range of electronic components in the industry.

There is nothing theoretical about the IRC standard of reliability. In most of the major avionic progress-projects, it is being proved out by rigorous field tests. It is also apparent in the way IRC resistors withstand extreme temperature, humidity, and mechanical conditions. It is evident, too, in resistance to shock and vibration . . . in improved shelf life . . . in the way IRC resistors consistently surpass MIL spec requirements.



INTERNATIONAL RESISTANCE CO. Dept. 239, 401 N. Broad St., Phila. 8, Pa.

RESISTOR	IRC TYPE	MIL TYPE	MIL SPEC.	WRITE FOR IRC BULLETIN
Fixed Composition	BT	RC	MIL-R-11B	B-1
Fixed Wire Wound (Low power)	BW	RU	JAN-R-184	B-5
Fixed Wire Wound (High power)	PWW	RW	MIL-R-26C	C-1
Fixed Wire Wound (Precision)	516L 316A	RB 17 RB52	MIL-R-93A MIL-R-93A	PH
Meter Multiplier (Sealed precision)	MF	MF	JAN-R-29	D-2
Deposited Carbon	DC	RN	MIL-R-10509B	B-4
Deposited Carbon (Molded)	MD	RN	MIL-R-10509B	B-9
Boron Carbon	BC	RN	MIL-R-10509B	B-6
Boron Carbon (Molded)	MB	RN	MIL-R-10509B	B-8
High Frequency	MP HFR	RF RF50	MIL-R-10683A MIL-R-10683A	F-1

COMPUTER COMPONENTS

Pressure Transducers
Digital Logic Elements

Packaged Custom Networks
Differential Transformers

Integrators
Static Switches

Magnetic Amplifiers
Shift Registers



AVRO AIRCRAFT LIMITED

CANADA

*Member: A. V. Roe (Canada) and the
Hawker Siddeley Group*

requires

MATHEMATICIANS AERODYNAMICISTS ENGINEERS

for Tactical Evaluation

Group and Aeroelastics Section

SENIOR PERSONNEL ARE REQUIRED FOR:

The evaluation of the tactical performance capabilities of supersonic weapon systems.

Studies of fire control effectiveness and data presentation.

Studies in air strategy.

Simulation studies of tactical problems.

The Company's extensive analogue and I.B.M.704 Digital Computing facilities are available for these studies.

Applications are invited from personnel with experience in one or more aspects of this type of work.

BENEFITS INCLUDE: Company-paid group life, sickness and accident insurance for you and your dependants, 8 statutory holidays with pay plus two weeks vacation with pay after one year. Contributory pension plan after two years.

Cost of transportation to Canada of successful applicants and families will be paid by the Company.

Assistance given in securing living accommodation.

APPLICANTS are invited to write, stating particulars of experience and qualifications, or personally call for application forms at Avro Aircraft Limited, Department 292, c/o Ontario Government Immigration Department, 12 New Burlington Street, London, W.1.

Selected applicants will be interviewed in the United Kingdom at an early date.



AVRO AIRCRAFT LIMITED

age between these points.

Model 20-C Vernistat transformer is 2.5 in. long by 2 in. in diameter. Circle 423 on Reader Service Card.



CONVERTER sine-to-square wave

MANDREL INDUSTRIAL INSTRUMENTS, Division of Mandrel Industries, Inc., P. O. Box 13243, Houston, Texas, announces a sine-to-square wave converter little larger than a man's hand. Novel with this \$25 plug-in gadget is its circuit which utilizes the signal from the driving oscillator to provide operating power for the transistor squaring circuit. Operating from 5 to 100,000 cps the unit is capable of 17 v peak-to-peak output upon being driven from almost any conventional oscillator. Rise time for the square wave produced is 0.5 percent of the period with a symmetry of 50 percent ± 2 percent. Having no critical components or batteries to replace, the life of the unit should be unlimited. Circle 424 on Reader Service Card.



AM-PM MULTIPLIER used in analog computers

CHADWICK-HELMUTH Co., 472 E. Duarte Road, Monrovia, Calif. A wide band, all-electronic analog computer multiplier designed for

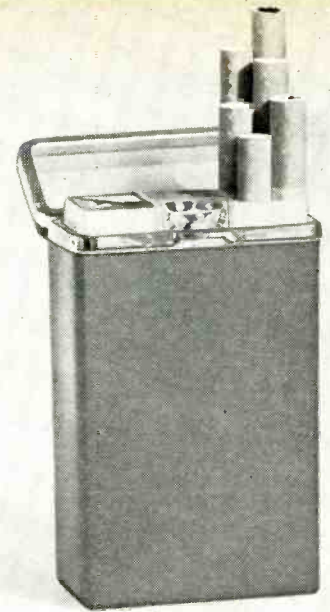

Not much taller than a pack of cigarettes...

See how much space you save with New Lambda COM-PAK® Power Supplies

**THREE VOLTAGE RANGES:
0-200, 125-325, 325-525 VDC**



Economically priced. 400 MA Lambda Com-Pak model (illustrated) needs only 5 1/4" of panel height, from \$244.50 Other models include 200 MA (5 1/4") priced from \$159.50, 800 MA (7") from \$315, and 1.5 amperes (8 3/4") from \$550.

C-200 series — 200 MA — need only 5 1/4" of panel height
C-400 series — 400 MA — need only 5 1/4" of panel height
C-800 series — 800 MA — need only 7" of panel height
C-1500 series — 1500 MA — need only 8 3/4" of panel height

*Space-saving models available
for all power supply needs
up to 1.5 amperes*

You get king-size performance as well as real space economy with Lambda's new Com-Pak regulated DC supplies. Completely new electrical and mechanical design. More functional — easier to combine with other components — designed for faster, handier maintenance and servicing.

400 MA and higher current range models have high-efficiency, long-life hermetically-sealed semi-conductor rectifiers. All Com-Pak models include hermetically-sealed transformers, chokes and capacitors.

FAST IN-RACK SERVICING

Wiring, tubes, and other components readily accessible. You can reach them easily, service them fast.



Quick rear access to tubes and controls.

Rear panel swings open for servicing.



LAMBDA Electronics Corp.

11-11 131 STREET • COLLEGE POINT 56, NEW YORK
INDEPENDENCE 1-8500 Cable Address: Lambdatron, New York

LAMBDA Electronics Corp., Dept. E-1157
11-11 131st Street, College Point 56, New York

Send me literature listing complete specifications for all Lambda Power Supplies.

Name _____ Title _____

Company _____

Address _____

City _____ Zone _____ State _____

BIG-POT PERFORMANCE in Miniature-pot size *Waters* ROTARY TRIMMER POTENTIOMETERS

are built, tested and certified* to rigid military environmental specifications and are available in many variations: ganged, tapped, with various electrical and mechanical angles, locking shafts, anti-rotation pins, "O" rings, custom shafts, and with the new Waters concentric shaft construction that provides two pots on a single mounting, with two separate controls.*Complete data on request.

CHECK THESE SPECIFICATIONS

NOW! A complete single-turn-pot line from *Waters*

Model	Resistance Range (ohms)	Standard linearity †	Case Dia. (inches)	Standard Shaft Dia. (inches)
AP 1/2	1/2 to 250 K	5% ‡	1/2	1/8
RT/RTS 7/8	1/2 to 250 K	3%	7/8	1/8-RTS 1/4
AP 1 1/16	1/2 to 350 K	2%	1 1/16	1/8
AP 1 1/8	1/2 to 350 K	2%	1 1/8	1/4
AP 1 5/8	1/2 to 500 K	1%	1 5/8	1/4

†For best possible linearity, submit detailed specifications. ‡±2% over 50K
 Bushing-mount standard. Servo and 3 hole mounting available. Standard resistances — all series: 50, 100, 200, 500, 1K, 2K, 5K, 10K, 20K and 25K, 40K and 50K also on RT/RTS 7/8; 40K, 50K, and 100K on AP 1 1/16, AP 1 1/8, and AP 1 5/8 series.
 Bushing for 1/8" dia. shaft is 1/4-.32 by 1/4" long.
 Bushing for 1/4" dia. shaft is 3/8-.32 by 3/8" long.

The most compact half-inch pot on the market.
 A dependable micro-miniature trimmer pot available with axial or radial terminals, in ganged units or in a special printed-circuit model.



**TYPE
AP 1/2**

An efficient, accurate, miniature trimmer pot for military and commercial installations that demand the most dependable components. Available with bushing or servo mount, or with concentric-shaft construction.



**TYPE
RT 7/8**

NEW A new addition to the Waters line, providing a reliable precision unit in the AIA nominal one-inch size. Available with bushing or servo mount. Non-linear design possible.

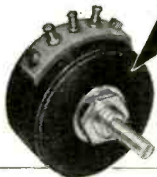

**TYPE
AP 1-1/16**

An old standby — providing higher resistance, better resolution and linearity but in miniature size. Available with bushing or servo mount, and with concentric shaft construction.



**TYPE
AP 1-1/8**

NEW Provides big-pot precision and reliability in a standard size unit by application of Waters miniature-pot design and assembly techniques. Ideal for non-linear applications.

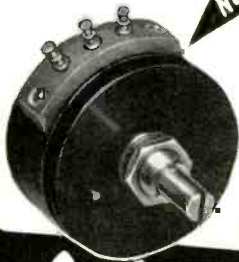

**TYPE
AP 1-5/8**

Write for catalog of the Waters complete single-turn pot line; *precision, trimmer, low-torque, miniature.*

high accuracy and speed is announced. The unit generates a voltage proportional to the instantaneous product of two arbitrary input voltages from d-c to 5 kc, with less than 5 μsec delay. Accuracy is ±0.1 percent of full scale over most of the band. After a short warmup, no adjustments are required for at least eight hours if accuracies of ±0.25 percent are adequate. Built-in metering system facilitates calibration and performance testing while unit is in use.

Multiplication is accurate and dependable over long periods of time since every active element is within a linear feedback loop, and operation does not depend upon the nonlinear characteristics of vacuum tubes or diodes. With no moving parts in the small and moderately priced unit, multiplication is accomplished at high speeds and with precision.

Model 251 operates with a 450 kc carrier, which is phase-modulated and amplitude-modulated by the two inputs to produce an output proportional to the product of these two modulating voltages. Modulation and demodulation is performed in diode-ring balanced modulators of special design to yield the required linearity, stability and trouble-free operation. **Circle 425 on Reader Service Card.**

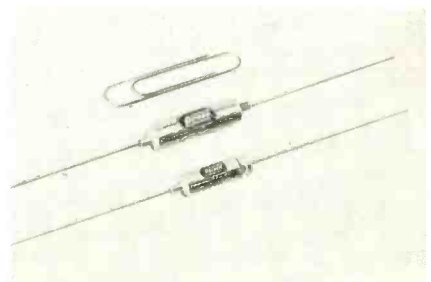

ELECTROLYTICS

feature subminiaturization

ASTRON CORP., 255 Grant Ave., East Newark, N. J. Types EE and EM subminiaturized electrolytic capacitors are announced.

The two subminiaturized units are especially designed for transistorized circuits and miniaturized low voltage d-c equipment. Featuring very low leakage characteristics for minimum battery

Waters
MANUFACTURING, inc.

APPLICATION ENGINEERING OFFICES
IN PRINCIPAL CITIES
Wayland, Massachusetts



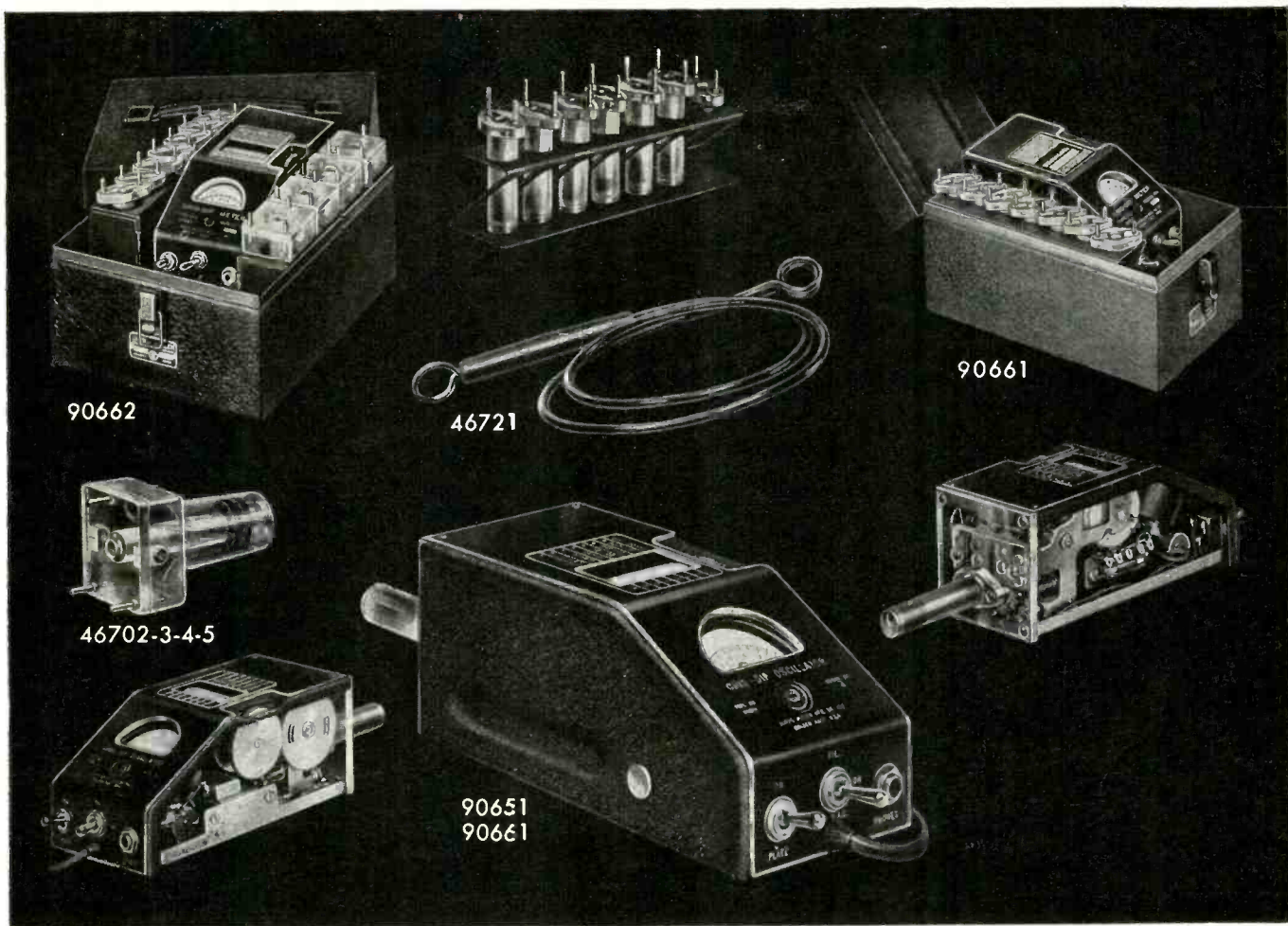

Designed for Application

Grid Dip Meters

Millen Grid Dip Meters are available to meet all various laboratory and servicing requirements.

The 90662 Industrial Grid Dip Meter completely calibrated for laboratory use with a range from 225 kc. to 300 mc. incorporates features desired for both industrial and laboratory application, including three wire grounding type power cord and suitable carrying case.

The 90661 Industrial Grid Dip Meter is similar to the 90662 except for a reduced range of 1.7 to 300 mc. It likewise incorporates the three wire grounding type cord and metal carrying case.

The 90651 Standard Grid Dip Meter is a somewhat less expensive version of the grid dip meter. The calibration while adequate for general usage is not as complete as in the case of the industrial model. It is supplied without grounding lead and without carrying case. The range is 1.7 to 300 mc. Extra inductors available extends range to 220 kc.

The Millen Grid Dip Meter is a calibrated stable RF oscillator unit with a meter to read grid current. The frequency determining coil is plugged into the unit so that it may be used as a probe.

These instruments are complete with a built-in transformer type A.C. power supply and internal terminal board to provide connections for battery operation where it is desirable to use the unit on antenna measurements and other usages where A.C. power is not available. Compactness

has been achieved without loss of performance or convenience of usage. The incorporation of the power supply, oscillator and probe into a single unit provides a convenient device for checking all types of circuits. The indicating instrument is a standard 2 inch General Electric instrument with an easy to read scale. The calibrated dial is a large 205° drum dial which provides seven direct reading scales, plus an additional universal scale, all with the same length and readability. Each range has its individual plug-in probe completely enclosed in a contour fitting polystyrene case for assurance of permanence of calibration as well as to prevent any possibility of mechanical damage or of unintentional contact with the components of the circuit being tested.

The Grid Dip Meters may be used as:

1. A grid Dip Oscillator
2. An Oscillating Detector
3. A Signal Generator
4. An Indicating Absorption Wavemeter

The most common usage of the Grid Dip Meter is as an oscillating frequency meter to determine the resonant frequencies of de-energized tuned circuits.

Size of Grid Dip Meter only (less probe): 7 in. x 3 $\frac{3}{16}$ in. x 3 $\frac{3}{8}$ in.

JAMES MILLEN



MFG. CO., INC.

MAIN OFFICE

AND FACTORY

MALDEN, MASSACHUSETTS, U. S. A.

look what **\$24⁵⁰** buys
in test equipment!

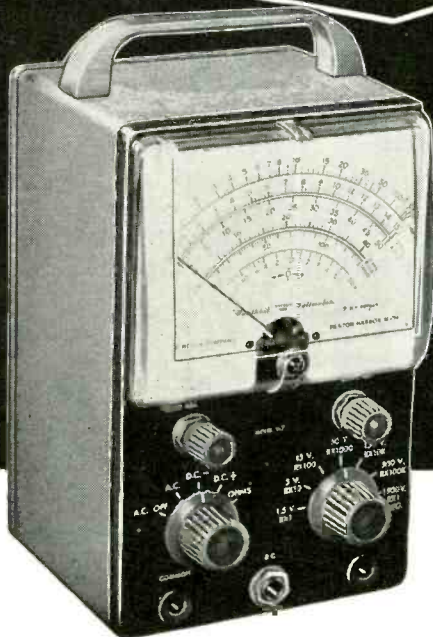

**HEATHKITS
GIVE YOU
TWICE AS MUCH
equipment for
every dollar
invested**

The famous model V-7A Vacuum-Tube-Voltmeter is a perfect example of the high-quality Instruments available from Heath at $\frac{1}{2}$ the price you would expect to pay! Complete, only **\$24⁵⁰**

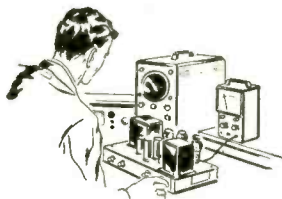

Get the most out of your test equipment budget by utilizing HEATHKIT instruments in your laboratory or on your production line. Get high quality equipment, without paying the usual premium price, by dealing directly with the manufacturer, and by letting engineers or technicians assemble Heathkits between rush periods. Comprehensive instructions insure minimum construction time. You'll get more equipment for the same investment, and be able to fill your needs by choosing from the more than 100 different electronic kits by Heath. These are the most popular "do-it-yourself" kits in the world, so why not investigate their possibilities in your particular area of activity! Write for the free Heathkit catalog now!



Contains detailed descriptions of Heathkit models available, including VTVM's, scopes, generators, testers, bridges, power supplies, etc.



Also describes Heathkit ham gear and hi-fi equipment in kit form. 100 interesting and profitable "do-it-yourself" projects!

FREE catalog

Mail coupon below for
your copy—Now!

HEATH COMPANY
A SUBSIDIARY OF DAYSTROM, INC.,
BENTON HARBOR 14, MICHIGAN

Name

Address

City & Zone

State

drain, types EE (epoxy and fill) and EM (spun end with rubber bushing) are extremely small hermetically sealed electrolytics (from $\frac{3}{8}$ in. by $\frac{1}{2}$ in. to $\frac{1}{4}$ in. by $\frac{3}{4}$ in.). They have applications in hearing aids, transistorized pocket radios, miniaturized recorders and many other miniature units.

Available in voltages of 1, 3, 6, 8, 16, 26, and 50, the new units also feature long shelf and operating life. Circle 426 on Reader Service Card.

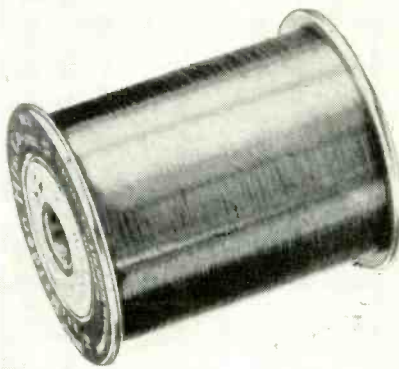

FILM-COATED WIRE solders at 700-750 F

BELDEN MFG. Co., Chicago, Ill., has developed a new Polyurethane film-coated wire which solders consistently (without stripping) at 700-750 F. The new wire, called Beldsol, is rated AIEE Class A-105C, but comparative tests have shown that Beldsol's thermal stability exceeds that of previously available magnet wires of the oleoresinous and the vinyl acetal types. Besides its solderable feature, Beldsol has excellent electrical properties, particularly in relation to insulation resistance in the presence of moisture. It combines low temperature solderability and a toughness of film coating comparable to Formvar, making a wire that is desirable for almost any winding where Formvar now is used satisfactorily. Thus Beldsol is especially well suited for h-f coils where high "Q" is required.

Other uses of Beldsol are practically unlimited. It can be wound into transformers, motor armature and field coils, radio and tv uni-

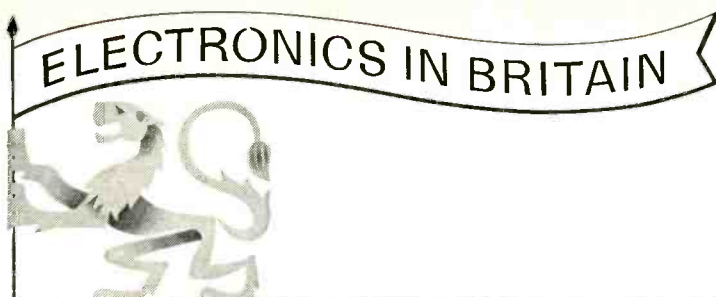

Six sound investments...



EF86

6267

Exceptionally low hum, low microphony and low noise tube. Specially designed for input stages of high sensitivity in high quality equipment.

The Mullard range of audio tubes has won universal acclaim among high fidelity sound experts: and it is easy to understand why. Every single tube in this range has been specially developed to meet the exacting needs of sound reproduction.

Read the specifications here; see for yourself what makes each tube such a sound investment.



ECC83

12AX7

Double triode with especially good microphony performance and high gain. Used in equipments where utmost versatility is required.



EL84

6BQ5

Economical, high sensitivity output pentode. Of miniature all-glass construction on the novel base. Two tubes in push-pull can provide 17W output for only 20V drive (grid-to-grid).



EL34

6CA7

High sensitivity 25W pentode. Two tubes in ultralinear push-pull provide up to 40W output. For public address work, two tubes in push-pull can supply up to 100W of audio power.

Supplies available from:
in the U.S.A.
 International Electronics Corporation,
 Dept. E11,81, Spring Street, N.Y. 12,
 New York, U.S.A.

in Canada
 Rogers Majestic Electronics Limited,
 Dept. 1K, 11-19 Brentcliffe Road,
 Toronto 17,
 Ontario, Canada.



EZ81

6CA4

Compact full-wave rectifier of miniature all-glass construction on novel base. Provides up to about 350V output at 150mA with good regulation.



GZ34

5AR4

Modern full-wave rectifier supplying up to 600V at 160mA, or 450V at 250mA with good regulation. Recommended for the larger type of Hi-F. equipment.



Mullard

ELECTRONIC TUBES

used throughout the world

MULLARD OVERSEAS LTD., MULLARD HOUSE, TORRINGTON PLACE, LONDON, ENGLAND

Mullard is the Trade Mark of Mullard Limited and is registered in most of the principal countries of the world. MEV 52

From the AMCI Catalogues

NEW PRODUCTS

(continued)

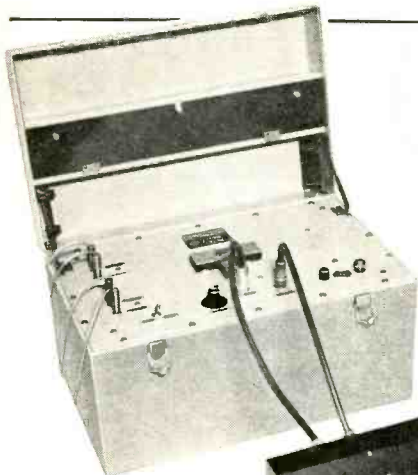

AUTOMATIC
IMPEDANCE
PLOTTERS



HYBRIDS



LINE STRETCHERS



RF TRANSFORMERS

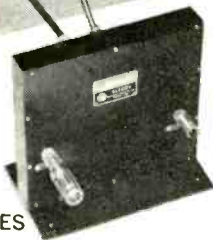

HYBRIDGES



SLOTTED LINES



CALIBRATED RF ATTENUATORS

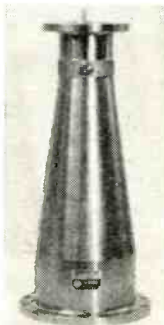

PRECISION
TAPERED
REDUCERS



VOR
ANTENNAS



COAXIAL
SWITCHES

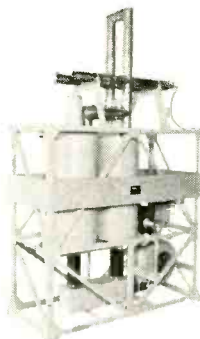

DIPLEXERS

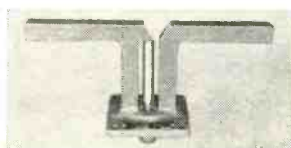

ANTENNAS

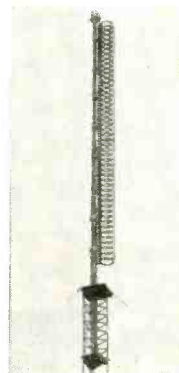

TV BROADCAST
ANTENNAS FOR
VHF AND UHF

versal coils, and many other random wound coils where solderability, coupled with excellent film abrasion resistance is required. It is available in sizes 14 through 40. Circle 427 on Reader Service Card.

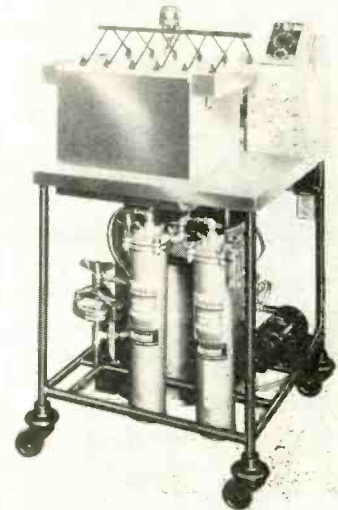

TRANSISTOR WASHER

with rinse tank

BARNSTEAD STILL & STERILIZER CO., 2 Lanesville Terrace, Forest Hills, Boston 31, Mass., has developed a special apparatus for washing and rinsing transistors and other small electronic parts in hot distilled-demineralized water. It has been found that rinsing in such water improves quality and reduces rejects. This equipment incorporates continuous repurification of the rinse water by ion-exchange plus activated carbon filtration of sub-microscopic particles to 0.45 micron. Washing and rinsing is accomplished in a five stage cascade type rinse tank. Rinse chambers are individually electrically heated and a regenerative heat-exchanger is employed in the circulating system to conserve electricity. Demineralizer and carbon filter are disposable cartridge type. Submicron filter employs replaceable membranes. The final rinse water is not only of high electrical resistance, 5,000,000 (18C) or more ohms, but is also free of organic impurities and submicroscopic particles which often contribute to substandard results.

The complete unit is mounted on

AMCI ANTENNA SYSTEMS - COMPONENTS - AIR NAVIGATION AIDS - INSTRUMENTS

ALFORD Manufacturing Co., Inc.
299 ATLANTIC AVE., BOSTON, MASS.

NEW
FROM
PYRAMID

DRY ELECTROLYTIC CAPACITOR FOR EXTREME TEMPERATURE RANGE REQUIREMENTS TYPE TR

For applications previously reserved for Tantalum capacitors, Pyramid announces a new high reliability, dry electrolytic to be designated as Type TR. These are extended life capacitors using high purity aluminum foil, and can be supplied for any capacity requirements desired. Units are available in both polarized and non-polarized construction.

4 OPERATING TEMPERATURE RANGES: Type 20-85 TR -20°C to $+85^{\circ}\text{C}$. Type 20-100 TR -20°C to $+100^{\circ}\text{C}$.
Type 40 TR -40°C to $+85^{\circ}\text{C}$. Type 55 TR -55°C to $+85^{\circ}\text{C}$.

CAPACITANCE TOLERANCES: Pyramid type TR units are made with commercial capacitance tolerances.

POWER FACTOR: TR units rated less than 15 working volts have a maximum power factor of 25% at 25°C and 120 cps. Type TR units rated 15 working volts and over have a maximum power factor of 15% at 25°C and 120 cps.

D.C. LEAKAGE: Leakage current limits for Pyramid type TR capacitors measured after the working voltage has been applied for 5 minutes may be determined from the following formulas: At 25°C ; $I=0.04CV$, At 85°C ; $I=0.35CV$, At 100°C ; $I=0.63CV$. Where: I =leakage current in microamperes, C =capacitance in microfarads, V =rated working voltage.

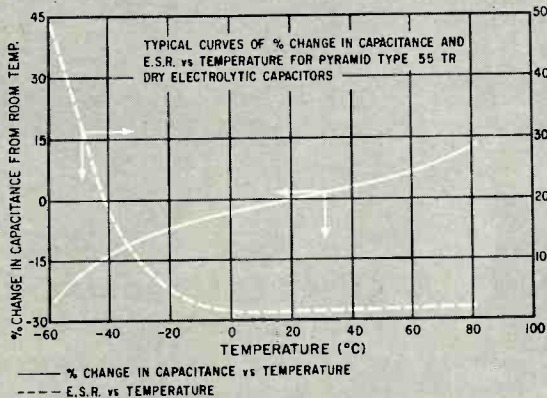

WORKING VOLTAGE: Pyramid type 20-85 TR can be supplied up to 450 working volts. Pyramid types 20-100 TR, 40 TR and 55 TR can be supplied up to 150 working volts.

SURGE VOLTAGE: The surge voltage rating of Pyramid type TR capacitors at 85°C and 100°C is 115% of the rated working voltage.

LIFE TEST: After 1000 hours at 85°C or 100°C , and working voltage applied, Pyramid type TR capacitors meet the following specifications at 25°C and 120 cps. The capacitance is within $+40\%$ of the capacitance measured before life test. The power factor is less than 150% of the power factor measured before the life test. The leakage current is within the limits specified above.

For circuit application information and a copy of TR Engineering Bulletin write to Industrial Division:

PYRAMID
ELECTRIC COMPANY
1445 HUDSON BOULEVARD
NORTH BERGEN, NEW JERSEY

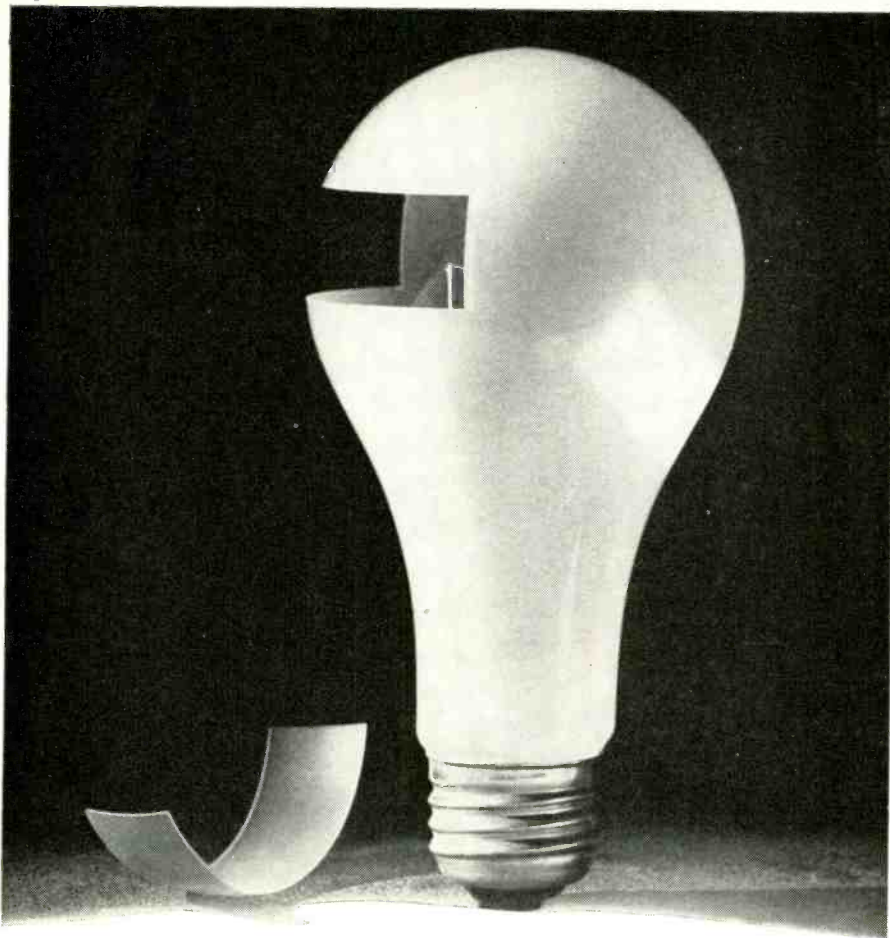

for Super-Fine Cutting
of Hard, Brittle Materials...
the *S.S. White*
Industrial Airbrasive® Unit

This delicate cutting job was done with our Industrial Airbrasive Unit . . . just to show you how its high-speed, gas-propelled stream of abrasive particles produces a fast . . . cool . . . shockless cutting action.

New industrial uses for the S. S. WHITE Industrial Airbrasive Unit are being discovered every day. Developed from the Airdent® equipment made by S. S. WHITE for the dental profession, the unit can be used in wire-stripping . . . calibrating . . . to remove surface deposits . . . etch glass . . . cut germanium and other crystalline forms . . . or to etch, drill or light-debur almost every hard, brittle material.

The Airbrasive Unit does these, and many other jobs that used to be difficult — or downright impossible — to accomplish by previously known methods. Think of your own product. Do you have a process that our unit can solve? Send us a sample and let us try out the unit for you. Or, for further information, just write to

S.S. White

First Name in Airbrasive Cutting

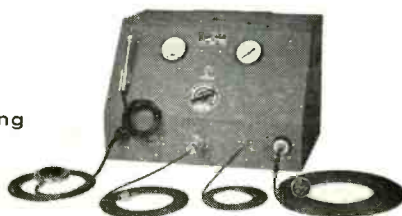

S. S. White Industrial Division, Dept. EU
10 East 40th St., New York 16, N. Y.

Western Office: 1839 West Pico Blvd., Los Angeles 6, Calif.

a mobile frame complete with circulating pump. **Circle 428 on Reader Service Card.**



HYSTERESIS MOTOR
three-speed type

TECHNICAL ELECTRONICS CORP., 4060 Ince Blvd., Culver City, Calif., has introduced a three-speed hysteresis motor which provides tape speeds of 3½ in., 7½ in., and 15 ips with a direct drive. Precision ground capstans are held to close concentric and diametrical tolerances and designed as an integral part of the rotor shaft to insure accurate velocities with minimum of flutter.

Quiet in operation, these motors are ideal as a precise drive for high fidelity recording and reproducing equipment such as tape recorders, computer storage drums and turntables. **Circle 429 on Reader Service Card.**

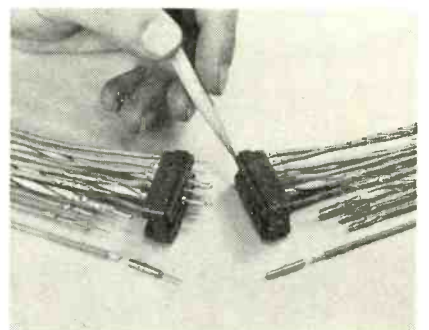

SOLDERLESS CONNECTOR
speeds electronic wiring

BURNDY CORP., Norwalk, Conn. A solderless multi-lead plug-and-receptacle connector designed to speed the wiring of electronic harnesses and achieve greater de-

Servo Motors For

Transistorized Operations

- Meets MIL-E-5272 • -65°C to $+125^{\circ}\text{C}$ temperature range.



	SIZE 8	SIZE 10	SIZE 11	SIZE 15	SIZE 18
Oster Type	8-5001-00	10-5052-00	11-5101-00	15-5153-00	18-5201-00
Electrical Characteristics:					
Frequency (cps)	400	400	400	400	400
Torque at Stall (oz. in.)	.15	.30	.63	1.45	2.35
No Load Speed (rpm)	6500	6500	6500	5200	5200
Speed at Half Torque (rpm)	4000	4000	4000	3200	3200
Time Constant (sec.)	0.03	0.015	0.016	0.017	0.013
Reversing Time (sec.)	0.051	0.025	0.028	0.030	0.022
Theo. Acceleration at Stall (rad/sec ²)	22500	45000	41500	31000	40000
Operating Temp. Range ($^{\circ}\text{C}$.)	-54 to $+125$	-54 to $+125$	-54 to $+125$	-54 to $+125$	-54 to $+125$
Slot Effect	1.6v/26v	1.0v/36v	1.0v/40v	1.0v/40v	1.0v/40v
Duty Cycle	Cont.	Cont.	Cont.	Cont.	Cont.
Fixed Phase					
Voltage	26	115	115	115	115
R (Stall) Ohms	196	1270	1250	490	280
X (Stall) Ohms	183	1560	1780	890	570
Z (Stall) Ohms	268	2210	2175	1030	640
P.F. (Stall)	0.73	0.57	0.58	0.49	0.45
Effective R (Stall) Ohms	366	3840	3800	2160	1460
Parallel Tuning cond. for unity P.F. (Stall) Mfd.	1.0	9.13	0.15	0.33	0.55
Control Phase					
Voltage	40/20	40/20	40/20	40/20	40/20
*R (Stall) Ohms	480	124	145	58	39
*X (Stall) Ohms	445	215	204	103	77
*Z (Stall) Ohms	660	248	250	118	86
*P.F. (Stall)	0.73	0.50	0.58	0.49	0.45
*Effective R (Stall) Ohms	910	495	430	240	190
*Parallel Tuning cond. for unity P.F. (Stall) Mfd.	0.4	1.4	1.3	2.9	4.1
Mechanical Characteristics:					
Rotor Inertia (gm. cm ²)	.47	.47	1.07	3.3	4.0
Weight (oz.)	1.2	2	4.5	8	14
Mounting Type	Synchro	Synchro	Synchro	Synchro	Synchro
Motor Length	.863	.672	1.703	1.625	2.03
Type Shaft	Pinion	Pinion	Plain	Plain	Plain
Shaft Extension	.375	.218	.437	.540	.540
Outside Diameter	.750	.937	1.062	1.437	1.750
Type Connection	Leads	Terminals	Terminals	Terminals	Terminals



Size 8

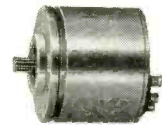

Size 10



Size 11



Size 15



Size 18

*For 40v connection

This complete line can be varied by Oster specialists to your precise requirement. Write today for further information, enclosing detailed data on your needs.

Other products include motor-gear-trains, synchros, AC drive motors, DC motors, servo mechanism assemblies, motor tachs, servo torque units, reference and tachometer generators, actuators, motor driven blower and fan assemblies and fast response resolvers.

John Oster

MANUFACTURING COMPANY
Your Rotating Equipment Specialist
Avionic Division
Racine, Wisconsin

Engineers For Advanced Projects:

Interesting, varied work on designing transistor circuits and servo mechanisms. Contact Mr. Zelazo, Director of Research, in confidence.

NOW...

ONE CALL FOR ALL

CANNON

PLUGS AND CONNECTORS

Standard, miniature, panel plugs and receptacles for all military and commercial applications.

No need to wait for deliveries of AN Connectors, UG Coaxial Connectors and RG Coaxial Cables. **PROGRESS** carries the *largest* inventory in the industry and all orders are shipped on the same day received. Call **PROGRESS** ... your one stop source for Cannon Electric, Diamond Division of Cannon, Amphenol Electronics, Industrial Products Co., Kings Electronics, Dage Electric and Federal Telephone & Radio products. Write for comprehensive free catalog No. 7.

*Get it today...
Get it from
Progress!*



CALL WOrth 2-8041
or wire/write...

PROGRESS
ELECTRONICS CO.
296 BROADWAY, NEW YORK, N. Y.

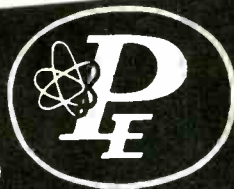

pendability and versatility has been introduced.

Called the Hyfen, the connector has two mating units, a plug and a receptacle. Instead of being soldered, pins and sockets are crimped to wire ends by single-stroke manual or high-speed automatic tools.

Elimination of solder fluxes and dissimilar metals improves resistance to corrosion. A minimum number of contact points also reduces reliability problems.

Crimping may be done before or after the harness is in place. Once wires are tipped with pins or sockets, they are snap-locked in the plug and receptacle, which may be mated as a gang connect or disconnect. Pins and sockets may also be pulled out separately to remove individual circuits.

Circle 430 on Reader Service Card.

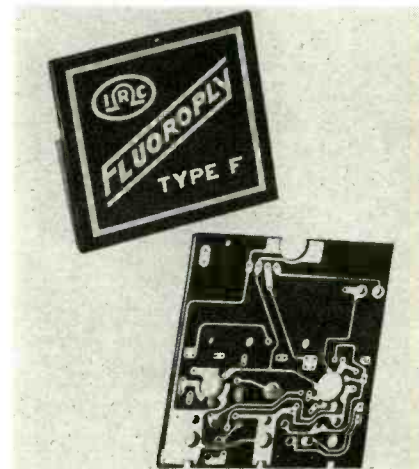

FLUOROPLY LAMINATE for printed circuit uses

INTERNATIONAL RESISTANCE Co., 401 North Broad St., Philadelphia 8, Pa., has added Fluoroply-F laminate for printed circuit applications to its product line. Fluoroply laminate type F provides high bond strengths of copper foil to plastic base without the use of adhesives. Fluoroply's special fluorocarbon plastic base eliminates the problems of water absorption and humidity surface leakage. Among the excellent electrical properties featured are high surface and volume resistivities, high dielectric strength, and good h-f characteristics. Arc re-

Get on the main line!

Your career rides the track of opportunity...at Western Electric

Engineering careers (yours included) can't help moving ahead at Western Electric. From the very first day on the job you find yourself surrounded by opportunities that spring out of the work we do and the status of our engineers.

The wide range of functions at Western Electric includes production, merchandising, purchasing, installation and other aspects of the overall job. Moreover, promotion from within is our policy. Today, fifty-five percent of the college graduates who have risen to the upper levels of Western Electric management have engineering degrees.

What would you do here? Well, maybe you'd help with our telephone job: making, distributing and installing the equipment needed for the nationwide Bell System network of 50 million telephones. Perhaps you'd have a hand in finding new — and better — ways of making telephones, central office switching systems, radio relay equipment; handle assignments involving miniaturization or automation.

In addition to our telephone work, there's a steady need for young engineers to help with our important government defense projects. The DEW Line of radar stations... the Nike guided missile system... White Alice — these are some of the important assignments the government has asked us to undertake.

The engineers who join us (mechanical, electrical, chemical, civil; physicists and mathematicians) will receive the security of a comprehensive retirement, benefit and insurance program... plus a chance to develop their professional skills through our Tuition Refund Plan and Graduate Engineering Training Program. Why not look into the career opportunities at Western Electric now. To apply, send resume of your education and experience to Engineering Personnel, Room 1066 Western Electric Company, 195 Broadway, New York 7, N. Y.

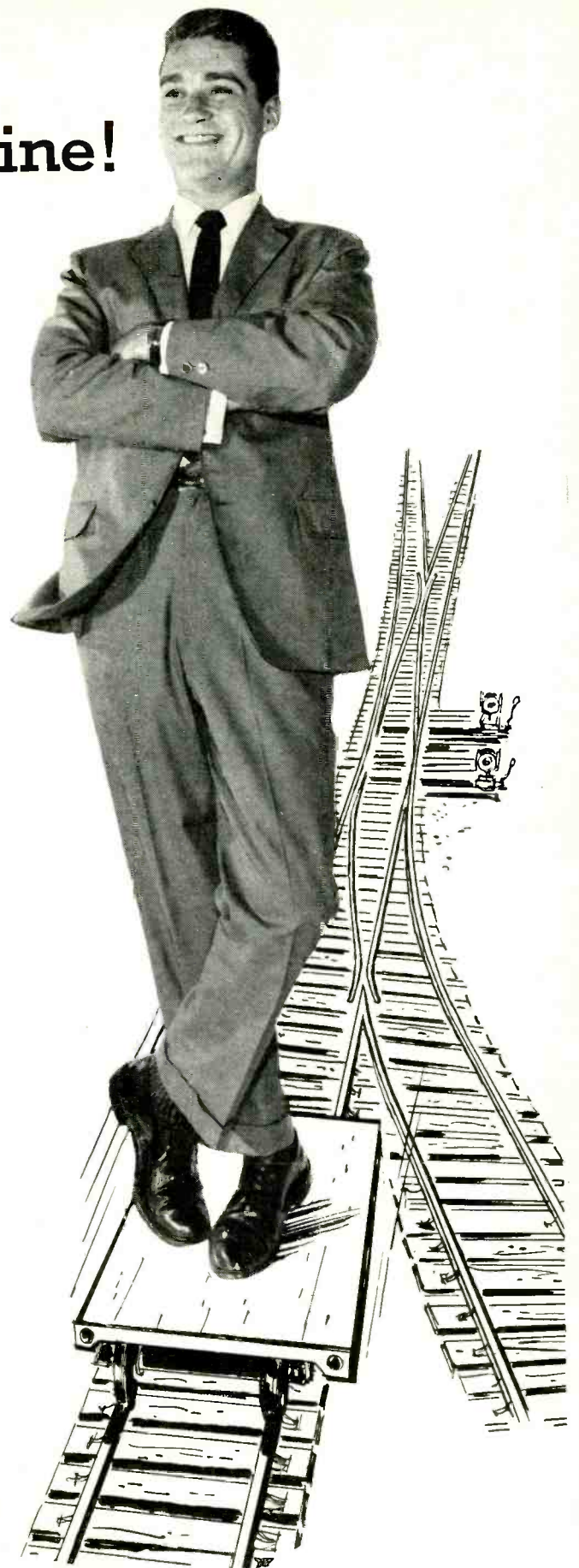

Manufacturing plants in Chicago, Ill.; Kearny, N. J.; Baltimore, Md.; Indianapolis, Ind.; Allentown and Laureldale, Pa.; Burlington, Greensboro and Winston-Salem, N. C.; Buffalo, N. Y.; North Andover, Mass.; Lincoln and Omaha, Neb.; St. Paul and Duluth, Minn. Distributing Centers in 30 cities and Installation headquarters in 16 cities. Also, Teletype Corporation, Chicago 14, Illinois.

On the board . . . in the laboratory . . . on the production line

HERE'S WHAT PANORAMIC'S WAVEFORM ANALYZERS HAVE DONE FOR OTHERS...SEE HOW MANY JOBS THEY CAN DO FOR YOU

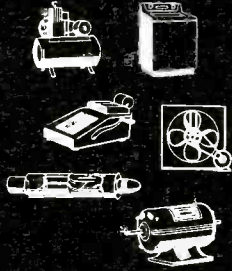

USED IN DESIGNING, IMPROVING AND PRODUCTION TESTING:

Ball bearings
Jet and reciprocating engines
Electric motors
Home appliances
Business machines
Pumps
Blowers and fans
Compressors
Air frames
Tire performance
Any rotating or oscillating machinery

PROVED PERFORMERS FOR:

Allis-Chalmers Mfg. Co.
Bell Aircraft Corp.
Bell Telephone Co.
Boeing Airplane Co.
California Institute of Technology
Chrysler Corp.
Convair
Cornell University
Curtiss Wright
Dept. of Defense
E. I. duPont de Nemours
Eastman Kodak Co.
Fairchild Engine & Airplane Corp.
Ford Motor Co.
General Electric Co.
General Motors Corp.
Hot Point Co.
Lockheed Aircraft Corp.
Massachusetts Institute of Technology
Phileo Co.
Pratt & Whitney Aircraft
Radio Corporation of America
Sperry Gyroscope Co.
U. S. Testing Co., Inc.
Western Electric

Fairchild Engineers use Panoramic's LP-1a, for rapid, reliable vibration analysis.



This is Panoramic's Sonic Analyzer Model LP-1a, an automatic vibration analyzer used by development engineers at Stratos Division, Fairchild Engine & Airplane Corp. to measure vibrations of airborne air conditioning packs.

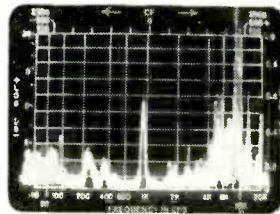

10-second screen photo of accelerometer output waveform as shown on the LP-1a's broad-band 40-20,000 cps logarithmic scale, linear amplitude (Courtesy of Fairchild Engine & Airplane Corp., Stratos Div.)

The direct reading spectrographic displays of vibration frequency components on the screen of the LP-1a are found to be a valuable aid in rapidly evaluating the dynamic performance characteristics of prototype units. The spectral distribution of the vibrations, sensed with a barium titanate accelerometer, facilitates monitoring specific elements of the pack such as bearings, impeller blades etc. because of the different motional frequencies associated with each. Relative "g" levels are shown by the amplitudes of the frequency components. The magnitude of vibration at the rotational rate is a reliable guide to the dynamic balance of the rotor.

The Fairchild air conditioning packs are tested at speeds up to 100,000 revolutions per minute thus precluding direct monitoring on the shaft. The pick-up is placed on the housing during test runs. The accompanying figure is illustrative of a broad-band, 40-20,000 cps logarithmic spectrum analysis of the accelerometer output waveform. For more detailed study of interesting regions of the band, the LP-1a features of narrow-band linear sweepwidths of ± 100 cps, ± 500 cps and ± 2500 cps are employed with any center frequency, from 0-20 kc.

Because of the LP-1a's simple operation and direct reading screen, non-professional personnel were trained in its use at the Stratos Division. They made Polaroid photographs of the screen displays thus freeing valuable engineering manpower.

Accessory equipment available with the LP-1a permits photographs or pen and ink recordings of waveform content to be made for detailed analysis and studies over extended periods of time. Other accessories aid in comparison of similar devices by alternating their spectrum analyses on successive scans.

Instruments for studies of transient and impact waveforms are among many new Panoramic Products. See how a Panoramic Waveform Analyzer can help you.

Write, wire, phone TODAY for more information and a copy of our new CATALOG DIGEST . . . ask to be put on the mailing list for the PANORAMIC ANALYZOR, our regular bulletin featuring application data.



530 South Fulton Ave., Mount Vernon, N. Y.
Phone: OWens 9-4600
Cables: Panoramic, Mount Vernon, N.Y. State

sistance of more than 360 sec makes Fluoroply-F superior in high voltage and high humidity applications.

Fluoroply can be readily cold-punched, drilled or machined. It is available in various sizes, thicknesses and colors. Circle 431 on Reader Service Card.

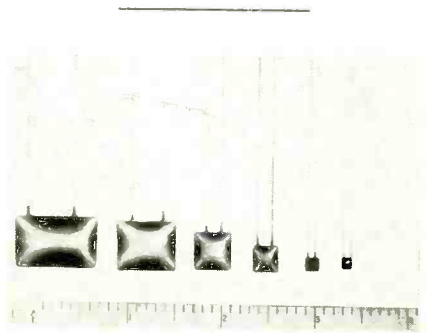

CERAMIC CAPACITOR ultrasubminiature type

VALCO DIVISION, National-El Ray Corp., 11815 Vose St., North Hollywood, Calif., has announced a newly developed ceramic capacitor which maintains 90 percent of room temperature capacitance at critical temperatures up to 150 C and down to -55 C. The Val-Cap ultrasubminiature capacitor is offered through the full RETMA decade of capacitance ratings from 47 to 100,000 $\mu\mu\text{f}$.

The smallest Val-Cap (47 $\mu\mu\text{f}$) measures only 0.1 by 0.1 by 0.1. Rated voltage is 100 to 200 wvdc, with up to 1,000 wvdc available.

The capacitors described use an exclusive new high density ceramic material possessing a very high dielectric constant and stable temperature coefficient. Circle 432 on Reader Service Card.

TRANSISTOR CLIP holds tiny components

GENERAL CEMENT MFG. CO., 400 South Wyman St., Rockford, Ill. Measuring 0.281 in. at its base, the new clip meets military requirements for retention of transistors and other rounded components used on printed circuit boards and conventional chasses.

Individual items such as diodes, relays, miniature capacitors, resistors and others that fall within

the pioneer is the leader



PANORAMIC

RADIO PRODUCTS, INC.

Get out your pencil and . . .

Help yourself to

electronics' READER SERVICE

it's free—it's easy—it's for your convenience

NOW!

All Advertisements
New Products, and
New Literature are
numbered for your
convenience.

Each Advertisement, New Product, and New Literature item is numbered.
For more information simply . . .

- (1) Circle number on postpaid card below that corresponds to number at the bottom of Advertisement, or New Product item. Follow the same procedure if you desire New Literature.
- (2) Print your name, title, address, and firm name carefully. It is impossible to process cards that are not readable.

Correct additional postage **MUST** be added to cards for all **FOREIGN MAILINGS**

NOV
1-57
CARD
EXPIRES
FEB • 1ST

• **electronics** • **READER SERVICE CARD**

Please Print Carefully

NAME _____ POSITION _____

COMPANY _____

ADDRESS _____

Some Advertisements which cannot be numbered for the READER SERVICE CARD due to lack of space, must be indicated by writing the Advertiser's name in the space provided at the bottom of the card . . .

1	2	3	4	5	6	7	8	9	10	11	12	13	14	15	16	17	18	19	20
21	22	23	24	25	26	27	28	29	30	31	32	33	34	35	36	37	38	39	40
41	42	43	44	45	46	47	48	49	50	51	52	53	54	55	56	57	58	59	60
61	62	63	64	65	66	67	68	69	70	71	72	73	74	75	76	77	78	79	80
81	82	83	84	85	86	87	88	89	90	91	92	93	94	95	96	97	98	99	100
101	102	103	104	105	106	107	108	109	110	111	112	113	114	115	116	117	118	119	120
121	122	123	124	125	126	127	128	129	130	131	132	133	134	135	136	137	138	139	140
141	142	143	144	145	146	147	148	149	150	151	152	153	154	155	156	157	158	159	160
161	162	163	164	165	166	167	168	169	170	171	172	173	174	175	176	177	178	179	180
181	182	183	184	185	186	187	188	189	190	191	192	193	194	195	196	197	198	199	200
201	202	203	204	205	206	207	208	209	210	211	212	213	214	215	216	217	218	219	220
221	222	223	224	225	226	227	228	229	230	231	232	233	234	235	236	237	238	239	240
241	242	243	244	245	246	247	248	249	250	251	252	253	254	255	256	257	258	259	260
261	262	263	264	265	266	267	268	269	270	271	272	273	274	275	276	277	278	279	280
281	282	283	284	285	286	287	288	289	290	291	292	293	294	295	296	297	298	299	300
301	302	303	304	305	306	307	308	309	310	311	312	313	314	315	316	317	318	319	320
321	322	323	324	325	326	327	328	329	330	331	332	333	334	335	336	337	338	339	340
341	342	343	344	345	346	347	348	349	350	351	352	353	354	355	356	357	358	359	360
361	362	363	364	365	366	367	368	369	370	371	372	373	374	375	376	377	378	379	380
381	382	383	384	385	386	387	388	389	390	391	392	393	394	395	396	397	398	399	400
401	402	403	404	405	406	407	408	409	410	411	412	413	414	415	416	417	418	419	420
421	422	423	424	425	426	427	428	429	430	431	432	433	434	435	436	437	438	439	440
441	442	443	444	445	446	447	448	449	450	451	452	453	454	455	456	457	458	459	460
461	462	463	464	465	466	467	468	469	470	471	472	473	474	475	476	477	478	479	480
481	482	483	484	485	486	487	488	489	490	491	492	493	494	495	496	497	498	499	500
501	502	503	504	505	506	507	508	509	510	511	512	513	514	515	516	517	518	519	520
521	522	523	524	525	526	527	528	529	530	531	532	533	534	535	536	537	538	539	540
541	542	543	544	545	546	547	548	549	550	551	552	553	554	555	556	557	558	559	560
561	562	563	564	565	566	567	568	569	570	571	572	573	574	575	576	577	578	579	580
581	582	583	584	585	586	587	588	589	590	591	592	593	594	595	596	597	598	599	600

INSIDE FRONT COVER

INSIDE BACK COVER

BACK COVER

NOW IN YOUR HANDS . . .

THE ALL NEW 1957 electronics BUYERS' GUIDE!

USE IT THROUGHOUT THE YEAR AS YOUR STANDARD REFERENCE SOURCE

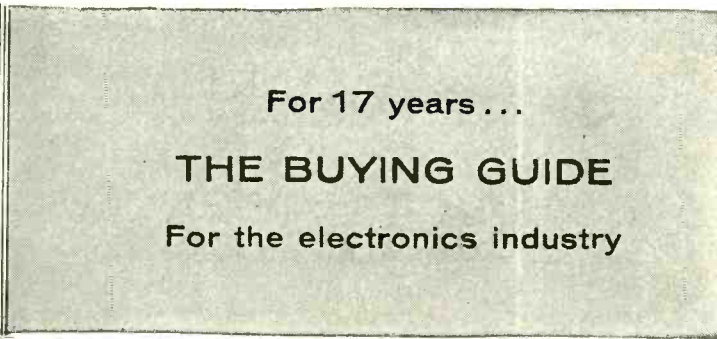
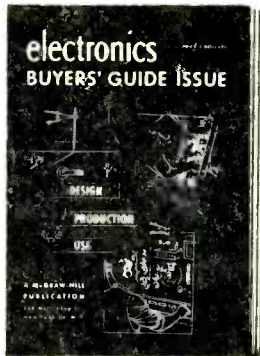

As easy to use as the telephone book, your all new 1957 electronics BUYERS' GUIDE features:

COMPLETENESS: 1070 pages of products, manufacturers, trade names, manufacturers' representatives, and professional services.

ACCURACY: The entire electronic industry is questioned from scratch each year. For the 1957 GUIDE, there were 181 changes, 586 deletions (of the deletions, many were due to mergers and name changes), and 872 additions. Total

number of manufacturers increased to 4013 from 3727 in 1956. 87 new products were added in 1957 for a total of 1773.

USE: Whether you are concerned with the design, production, or use of electronic circuitry, turn to the listings of the electronics BUYERS' GUIDE. Here you will find the page numbers that refer you to catalog-type advertising, specially prepared to supplement the listings and give you the technical information you must have to specify and purchase electronic and allied products.



A McGraw-Hill Publication, 330 West 42nd Street, New York 36, N. Y.



FIRST CLASS
PERMIT NO. 64
(Sec. 34.9 P.L.&R.)
NEW YORK, N. Y.

BUSINESS REPLY CARD

NO POSTAGE STAMP NECESSARY IF MAILED IN THE UNITED STATE

4¢ Postage Will Be Paid By

ELECTRONICS

Reader Service Dept.

330 West 42nd Street

New York 36, N. Y.

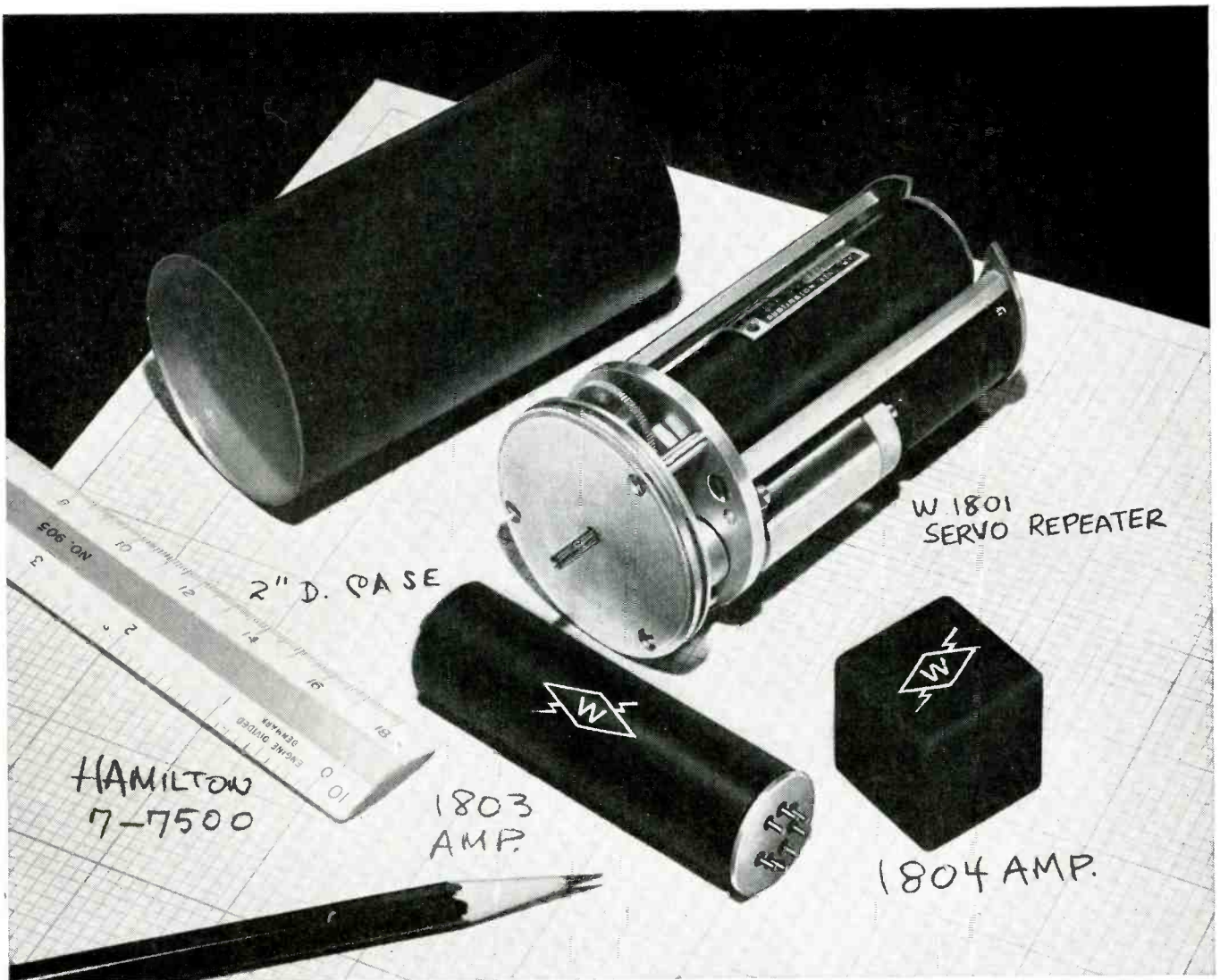

Waldorf announces an important new design concept... MICROMATION

MICROMATION—the logical result of Waldorf's unique talent for compressing more performance and reliability into less space.

MICROMATION—making use of Waldorf's credo of less space, less weight, less heat, less power, to provide just the first of a series of related components and assemblies for servo and computer applications.

MICROMATION now makes available—

Model W1801—Transistorized Servo Repeater System; size 2" Dia. x 4" long, weight 13 oz. including amplifier and power supply.

Model W1803—Transistorized Servo Amplifier; size 13/16" Dia. x 2 3/4" long, weight 2 oz.

Model W1804—Transistorized Servo Amplifier; size 1" x 1" x 1".

In the housing of the W1801 Servo Repeater System illustrated are all the electronic and electromechanical components to develop shaft position output with torque exceeding 20 oz.-in. Static accuracy is within 0.1° of input from synchro or transducer. Velocity constant is 60 sec.⁻¹. Requires only 115V, 400 cps supply. Other configurations are available to suit your requirements. Uses include control of positioning devices, valves or computer elements.

May also be used as aircraft indicators. Meets military specifications.

Model W1803 Amplifier as used in the W1801 Servo Repeater is designed for minimum mounting surface—13/16" Dia.

Model W1804 Amplifier is identical electrically but packaged for minimum volume—1" x 1" x 1".

Both accept synchro, potentiometer, or other transducer data. Both drive size 8 or size 10 motors.

Interested?

If these product improvements—or the coming innovations in **MICROMATION**—integrators, differentiators, coordinate-converters, vector solvers and power supplies challenge your imagination, why not ask for further data?

Waldorf

INSTRUMENT COMPANY

Division of F. C. Huyck & Sons

DEPARTMENT EA-44 • ELECTRONICS DIVISION • WALDORF INSTRUMENT COMPANY • HUNTINGTON, LONG ISLAND, NEW YORK

TRANSFORMER NEWS

FROM TRIAD



NEW CHOPPER INPUT TRANSFORMERS

Designed to operate from the A. C. input in the microvolt range as generated by a chopper are two new Triad transformers. A typical application in the Kintel Model 402A Electronic Galvanometer is shown above. Features of these transformers which make them exceptionally desirable for chopper input are: (1) Two halves of primary matched to $\pm 0.1\%$. (2) Multiple alloy shielding. P-5H shielding reduces pickup 135 db in the most effective plane. (3) Hermetically sealed. Construction to meet environmental requirements of MIL-T-27A. Brushed nickel finish. (4) Minimum noise. Treated to eliminate mechanical noise. (5) High gain at operating freq. (60 to 400 cps.).

Two models are supplied:

G-22 50,000 ohms C.T. to 800,000 ohms C.T. with a minimum primary inductance of 1000 henries at 10 MV.—60 cycles. List Price: \$49.50

G-20 10,000 ohms C.T. or 2,500 ohms to 640,000 ohms C.T. with a minimum primary inductance (series connection) of 120 henries at 10 MV.—60 cycles. List Price: \$45.85

Above units available from stock. We will be glad to quote on special items to meet other requirements.



(Reduced Inspection—Quality Assurance Plan)

Your own incoming inspection and field service requirements are reduced to a minimum when you specify Triad. All Triad Transformers are manufactured under this Signal Corps approved plan for quality assurance. RIQAP is awarded only to those companies who continue to maintain Signal Corps standards.

4055 REDWOOD AVENUE, VENICE, CALIFORNIA
812 E. STATE STREET, HUNTINGTON, INDIANA

A SUBSIDIARY OF LITTON INDUSTRIES



its size limits are gripped securely by the new clip even under extreme vibration or shock conditions. Only finger pressure is necessary for insertion or removal of the component. The stainless steel clip can be fastened in place by rivet, solder or dip-solder methods. Circle 433 on Reader Service Card.



DPDT SWITCH features one-way action

ELECTRO SNAP SWITCH & MFG. CO., 4218 West Lake St., Chicago 24, Ill. A new Electro-Snap die-cast switch provides simultaneous, one-way action on two poles. Exclusive one-way action results in an electrical impulse on the inward stroke and does not operate the switch on return to its normal position. The snap-action of the four-circuit switch mechanism is totally independent of the speed of the plunger movement.

The dpdt basic switch is housed in an aluminum die-cast case with a splash-proof neoprene boot to protect its switching mechanism. The ES4-DM3 is designed to eliminate complicated one way dogs, extra switches, and costly relays. It is

NEWS ABOUT SILICON DEVICES

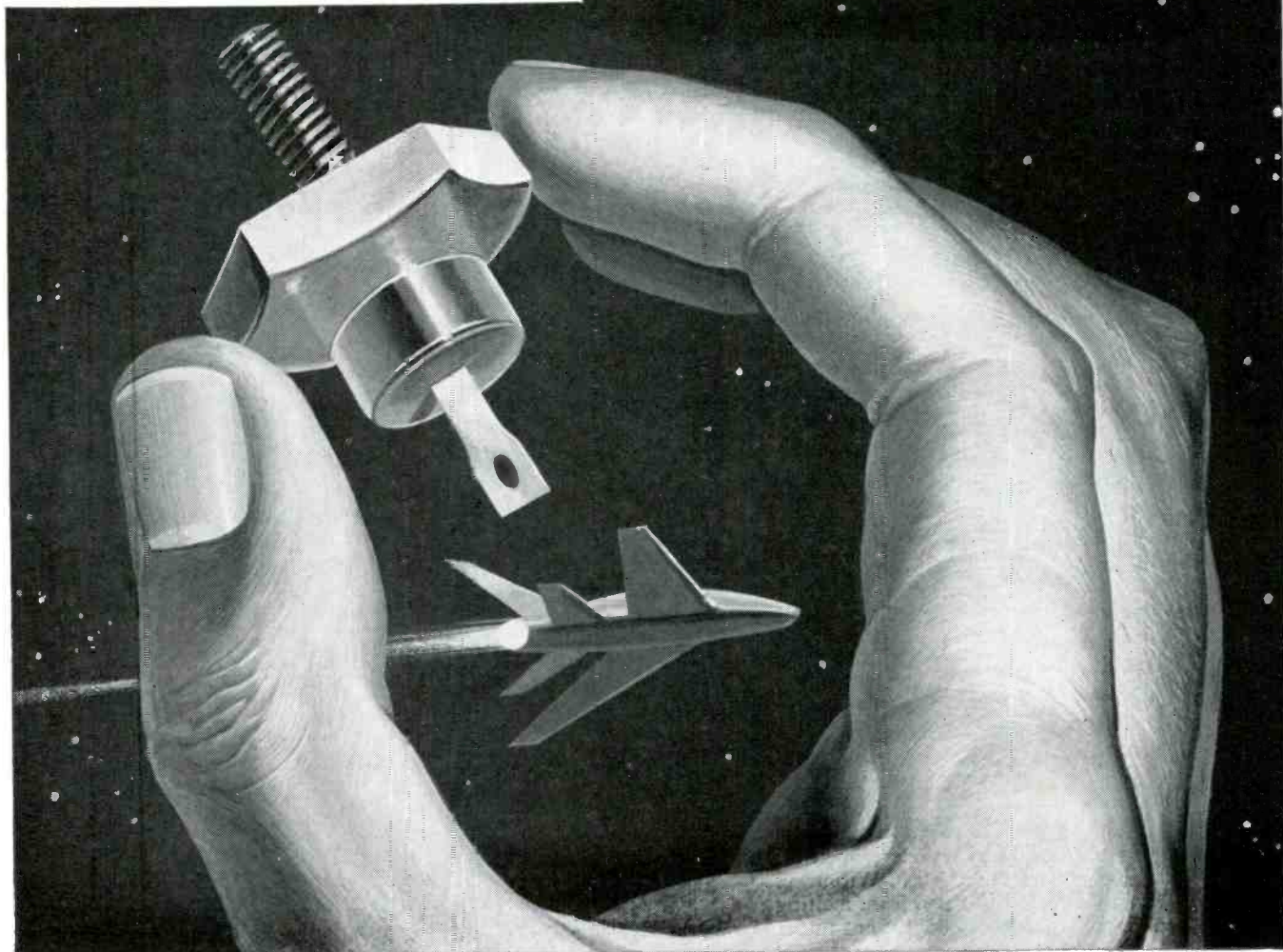

SILICON RECTIFIERS are finding increasing use at elevated temperatures in aircraft and missile applications by providing more power per pound.

Now...design improvements made possible with components of Du Pont Hyperpure Silicon

Today silicon rectifiers make possible a vast improvement in jet-age aircraft generators—the use of engine oil as a coolant instead of less-efficient ram air. Silicon rectifiers take the place of oil-sensitive brushes, commutator and slip rings . . . are completely unaffected by 150°C. engine oil. Result: a *brushless* generator of less weight and size than ordinary generators.

Silicon devices can similarly help **you** miniaturize—improve design and performance. Silicon rectifiers have excellent stability . . . can operate continuously at -65 to 200°C. They're up to 99% efficient—reverse leakages are only a fraction of those of other semiconductors. Both transistors and rectifiers of silicon can pack *more* capacity into *less* of your equipment space.

Note to device manufacturers:

You can produce high-quality silicon transistors and rectifiers with Du Pont Hyperpure Silicon now available in three grades for maximum efficiency and ease of use . . . purity range of 3 to 11 atoms of boron per billion . . . available in 3 forms, needles, densified, cut-rod. Technical information is available on crystal growing from Du Pont . . . pioneer producer of semiconductor-grade silicon.



NEW BOOKLET ON DU PONT HYPERPURE SILICON

You'll find our new, illustrated booklet about Hyperpure Silicon helpful and interesting—it describes the manufacture, properties and uses of Du Pont Hyperpure Silicon. Just drop us a card for your copy. E. I. du Pont de Nemours & Co. (Inc.), Silicon N-2496-E-11, Wilmington 98, Delaware.

PIGMENTS DEPARTMENT



REG. U. S. PAT. OFF.

BETTER THINGS FOR BETTER LIVING
... THROUGH CHEMISTRY

THE *Specialized* ALLOY FOR GLASS HERMETIC SEALS

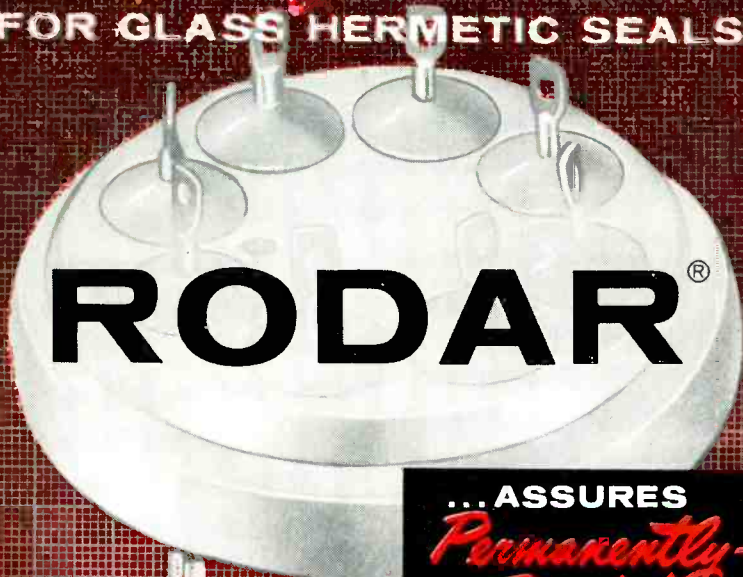

RODAR®

... ASSURES
*Permanently
Bonded*
VACUUM-TIGHT
SEALS!

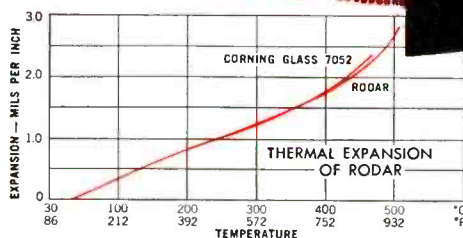

This precision alloy was developed for sealing metal to hard glass. Wilbur B. Driver Rodar is processed from melting to finished size in our own plant under the strictest controls to insure consistent analysis, temper, uniform grain size and conformance to customers' specifications. The superior stamping and sealing properties of Rodar make it *the preferred sealing alloy*.

Rodar produces a permanent, vacuum-tight seal with simple oxidation procedure and resists attack by mercury. Readily machined and fabricated, Rodar can be welded, soldered or brazed. Available in wire, strip and bar to your specifications.

Another Special Alloy for a Specific Purpose

PROPERTIES

Composition (Nominal)	
Nickel	29%
Cobalt	17%
Manganese	30%
Iron	Balance
Melting Point	.. 1450°C. (Approx.)
Specific Gravity	8.36
Weight Per Cubic Inch	302 lb.
Electrical Resistivity	294 Ohms C.M.F.
Tensile Strength	80,000 PSI
Hardness	82 B Rockwell
Elongation	30% (2" gauge length)

Temperature Range	Average Thermal Expansion, *Cm/Cm/°Cx10 ⁻⁶
30° To 200 C.	4.33 To 5.30
30° To 300 C.	4.41 To 5.17
30° To 400 C.	4.54 To 5.08
30° To 450 C.	5.03 To 5.37
30° To 500 C.	5.71 To 6.21

*As determined from cooling curves, after annealing in hydrogen for one hour at 900°C. and for 15 minutes at 1100°C.



**WILBUR B.
DRIVER CO.**
NEWARK 4, NEW JERSEY

claimed to be excellent for pulsing electrical control on both pneumatic and hydraulic valves and other similar installations requiring momentary one-way electrical impulses. The simultaneous break of two poles permits great flexibility in wiring variations. The switch is rated at 15 amperes 125/250 v a-c, 30 v d-c. **Circle 434 on Reader Service Card.**



MULTIMETER for data link application

DEJUR-AMSCO CORP., 45-01 Northern Blvd., Long Island City 1, N. Y., announces availability of a multimeter for data link or analog application with a maximum of four simultaneous readouts. This unit is a 3-in. AN type meter, hermetically sealed and gas filled. It is completely ruggedized in a shielded, steel case. Maximum sensitivity is 200 μ a for each display. Complete specifications are available. **Circle 435 on Reader Service Card.**



A-C ELECTROMETER micromicroammeter type

THE VICTOREEN INSTRUMENT CO., 5806 Hough Ave., Cleveland 3, Ohio. Model 565A micromicroammeter electrometer was designed for measuring low currents in ion

2-SPEED SERVO DRIVEN INDICATOR

Each input of this 5-channel servo system drives a synchro transmitter through a gear reduction of 5 to 1. Indicator controlled by a size 9 motor operating off a 2-stage transistorized amplifier with a gain of 60 to 1. Indicator synchro is geared at 1 to 1 for slow resolution, 36 to 1 for fast resolution. Error is ± 5 minutes indicated.

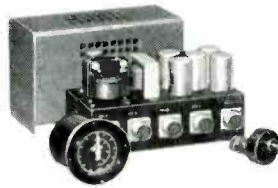

servo problems stock units can't solve

This equipment "does the job right" because it was especially designed for a single application . . . by a company whose major function is solving individual servo control problems with complete, precisely engineered and manufactured servo assemblies.

Of course, if you just want servo *components*, Daystrom Transicoil can provide them to the highest order of precision and accuracy. But it is in the "package" engineering of unique assemblies that Daystrom Transicoil's experience and creative imagination offer the greatest value. And in most cases, these assemblies cost no more than the individual components would purchased separately.

Check out your next servo problem with Daystrom Transicoil first. Ask for the new gear-motor availability guide if you haven't yet received a copy.



DAYSTROM TRANSICOIL CORP.

A Subsidiary of Daystrom, Inc.

Worcester • Montgomery County • Pennsylvania

profile of a
very special guy
 ... the Lenkurt
 engineer

- Special, because with Lenkurt — leading specialist in telecommunications — he has found the challenges and inspirations, the responsibilities and recognition that add up to a truly satisfying career.
- Special, because he is planning and building the communications systems of tomorrow.
- Special, because at San Carlos, on the sunny San Francisco peninsula, he has found the ultimate in what is known the world over as "California living."

A few very special guys whose field of interest is communications will find these opportunities at Lenkurt most attractive:

Project Engineers — High level positions requiring at least 8 years professional history in communications equipment design, component development, or systems planning. Graduate study desirable.

Electronics Engineers — Knowledge of circuit design including amplifiers, oscillators, modulators, and regulators, utilizing tubes and transistors. Good background in test procedures and test equipment; BSEE with communications option desirable.

Assistant Electronics Engineers — Graduate engineers who have an interest in circuit analysis and experimentation and want to gain experience as members of an engineering team working on advanced development projects.

Lenkurt
ELECTRIC
 San Carlos 3, California

Please send your resumé to Jack Shannahan, Engineering Placement Manager

chambers and high-impedance networks. It conforms to ORNL Specification Q826B.

Accuracy of the system is better than 1 percent of full scale. Stability after the first hour of operation exceeds 1 percent per 24 hours. Linearity is ± 1 percent of full scale.

Extremely sensitive, the 565A can detect differences of current as small as $5X 10^{-15}$ amperes. With minimum capacity in the circuit, the RC time-constant is approximately 10 seconds. Each additional micromicrofarad of capacity increases the time-constant by 1 second.

The unit incorporates five ranges of from 2.5×10^{-9} to 2.5×10^{-13} amperes. Maximum full-scale current sensitivity is 2.5×10^{-13} amperes; maximum full-scale voltage sensitivity is 0.25 v. Circle 436 on Reader Service Card.

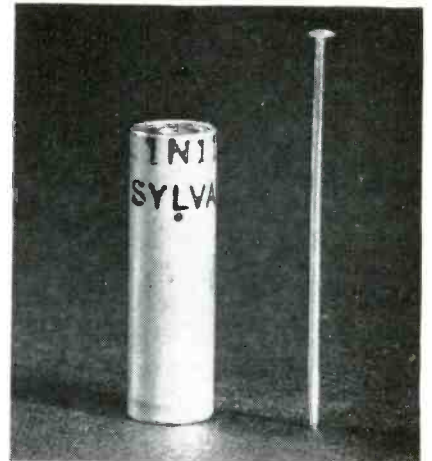

MIXER DIODE
 for radar applications

SYLVANIA ELECTRIC PRODUCTS INC., 1740 Broadway, New York 19, N. Y. The 1N1132 broadband mixer diode is of tripolar construction and covers the frequency range from 3 kmc to 12.4 kmc in a single coaxial holder. Its characteristics contribute to a simplified, more compact system for radar applications.

Only $\frac{3}{8}$ in. long and about $\frac{1}{16}$ in. in diameter, the new broadband crystal diode is the mixer counterpart of Sylvania's low-level tripolar video detector.

Input of the 1N1132 covers any frequency from S through X-

Drift and aging problems solved with these new computer-type transistors

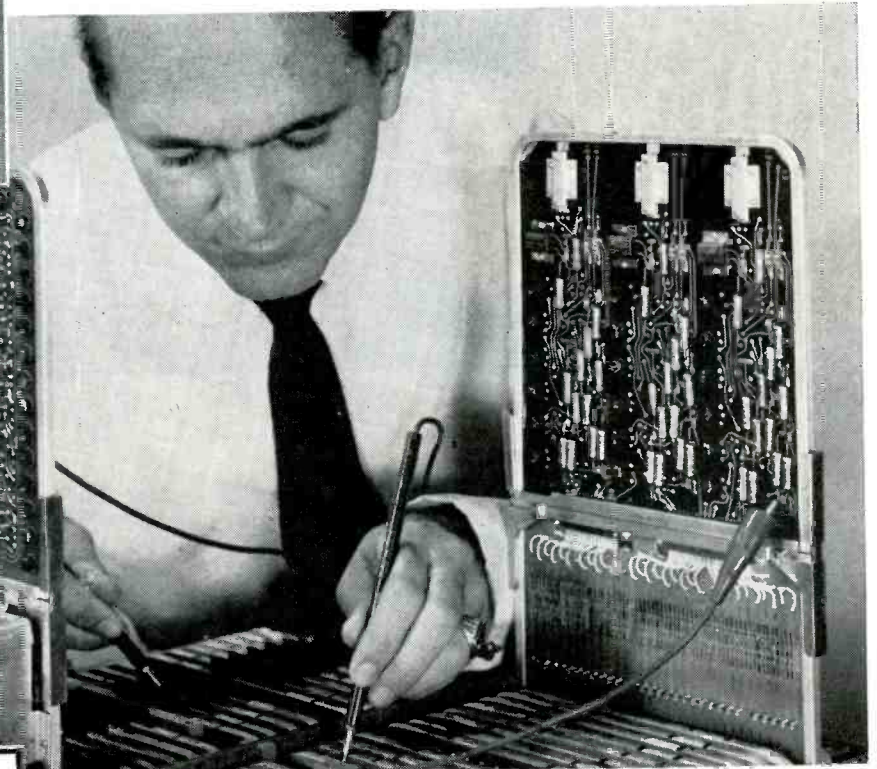
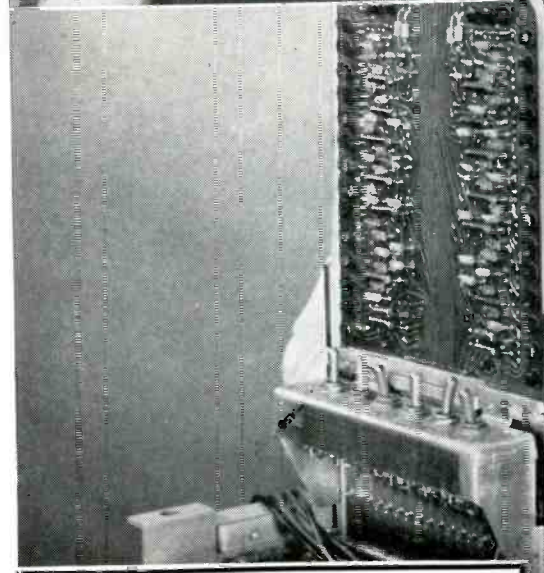
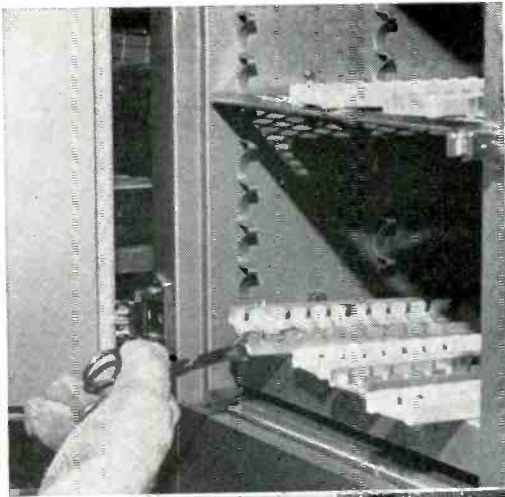

CHECK THE G-E TRANSISTOR DESIGNED SPECIFICALLY FOR YOUR COMPUTER SYSTEM

Computer system	G-E transistor type	Characteristics
DCTL logic	2N430 (silicon)	Low saturation resistance, controlled input characteristics.
NOR logic	2N430 (silicon)	Low saturation resistance, controlled input characteristics.
	2N396 (germanium)	Negligible aging, high speed, low saturation voltage.
DIODE logic	2N397 (germanium)	High peak power dissipation, high current gain at high collector currents, negligible aging.
Magnetic Drum Storage	4JD1B series (germanium)	Controlled current gain in either direction at 200 ma, one ampere peak currents, high dissipation, high voltage rating.
General Purpose	2N430 thru 2N434 (silicon)	Low I_{co} , narrow beta range, low saturation resistance.
	2N123 (germanium)	Proved in years of duty, high peak dissipation, 7 mc alpha cutoff.
	2N43 (germanium)	Low speed, high gain, 1 mc alpha cutoff, proved in years of duty.
Analog Computer Amplifiers	2N167 (germanium)	Low I_{co} , high output impedance, high current gain at low collector currents, high speed.

2N390 series added to General Electric's line of transistors for all computer systems

Characteristics of transistors have been known to change from the time when they've been subjected to manufacturer's heat tests until months later when they're finally at work in a computer. But not the new 2N390 series.

Each 2N390-series transistor exhibits parameters within a 10 per cent (plus or minus) drift area with time or under any storage conditions for which they are rated. You can depend on I_{co} and beta to remain stabilized.

Call your local General Electric representative for all the details on the new 2N390 series and other transistors. No matter what computer system you are working on, there are General Electric transistors specially designed for it. Or write *General Electric Company, Semiconductor Products Department, Section S25117, Electronics Park, Syracuse, N. Y.*

SPECIFICATIONS	2N397	2N396
Collector to Emitter (25°C)	—10 volts	—20 volts
Collector Current (25°C)	—250 ma	—200 ma
Power Dissipation (25°C)	150 mw	150 mw
Alpha Cutoff Frequency*	8 mc (min)	5 mc (min)
Collector Cutoff Current	—6 μ amp (max)	—6 μ amp (max)
Emitter Cutoff Current	—6 μ amp (max)	—6 μ amp (max)

*Common base— $V_{cb} = -5$ volts, $I_e = 1$ ma.

Progress Is Our Most Important Product

GENERAL  ELECTRIC

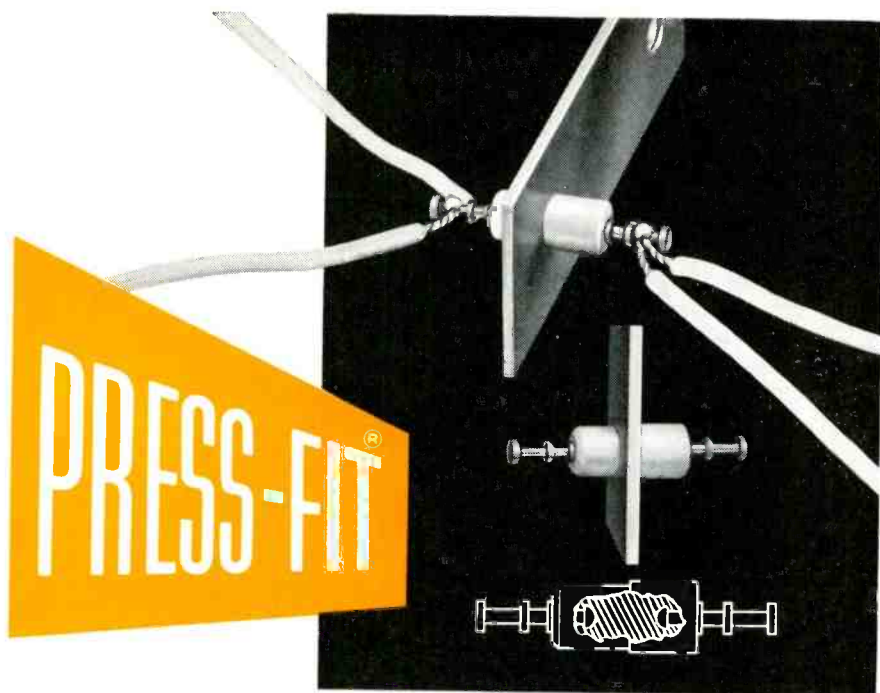

DOUBLE HEADER

TEFLON[†]-INSULATED STANDOFF TERMINALS

Another Sealectro First!

The exclusive Press-Fit "Double Header" provides in a single unit **two** insulated standoffs that mount in **one hole**. Connections made on either or both sides of chassis, independently of each other (not a feedthru). Saves space, labor, time, money. Series DST is available in six standard types. Pin or turret lugs. 3500 to 5500 volt nominal ratings. And available in eight code colors.

Just another example of the outstanding versatility of **genuine** Sealectro Press-Fit terminals. Over 600 standard numbers to choose from. Featuring Teflon insulation advantages, one-piece construction, jiffy installation, stay-put performance.

New Manual

Brand new edition. More pages, listings, engineering data. Write for copy.

†Trademark of E. I. Du Pont de Nemours & Co., Inc.



Sealectro
CORPORATION

610 Fayette Avenue, Mamaroneck, N. Y.

band, and it has a low noise figure over this range. With a built-in r-f bypass capacitor, the diode also has a separate output terminal for i-f which eliminates r-f chokes. Another feature is the simplified, low-cost mount design, used with the tripolar 1N1132.

At 25C, maximum overall noise figure is 9.5 db, i-f impedance is 100 to 200 ohms, and r-f impedance (vswr maximum) is 2.0. Ambient temperature is -40 C to +70 C. **Circle 437 on Reader Service Card.**



PULSE DELAY UNIT features compactness

ELECTRICAL AND PHYSICAL INSTRUMENT CORP., 42-19 27th St., Long Island City 1, N. Y., has available a pulse delay unit which allows delays of 5, 10, 15, 25, 50 and 100 millimicroseconds and combinations of these delays. Standard coaxial cables of 53, 73 and 93 ohms are used for these delays in order to maintain a fast rise time and minimize pulse shape distortions. The rise time for a step function input is less than one millimicrosecond for pulse delays of 25 millimicroseconds or less and less than 5 millimicroseconds for a 100 millimicrosecond delay. BNC connectors are mounted on the front panel at the beginning and end of each delay. Adaptors from BNC to either uhf or type N are provided so that variation of the delay inserted in a cable with these connectors can be effected in a simple manner.

Dimensions of the pulse delay unit are 12 in. high by 7 in. wide



How to keep informed on the “with what” part of your business

AT YOUR FINGER TIPS, issue after issue, is one of your richest veins of job information — advertising. You might call it the “with what” type — which dovetails the “how” of the editorial pages. Easy to read, talking your language, geared specifically to the betterment of your business, this is the kind of practical data which may well help you do a job quicker, better — save your company money.

Each advertiser is obviously doing his level best to give you helpful information. By showing, through the advertising pages, how his product or service can benefit *you* and *your* company, he is taking *his* most efficient way toward a sale.

Add up all the advertisers and you've got a gold mine of current, on-the-job information. Yours for the reading are a wealth of data and facts on the very latest in products, services, tools . . . product developments, materials, processes, methods.

You, too, have a big stake in the advertising pages. Read them regularly, carefully to keep job-informed on the “with what” part of your business.



McGraw-Hill PUBLICATIONS

we don't make
a "SPECIAL"
of *sealing out*
SMOG,
SMOKE
and SWEAT

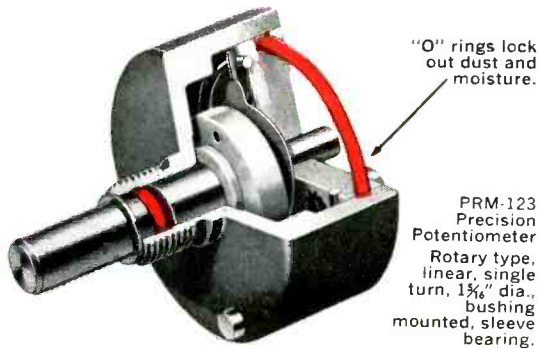

PRM-123
Precision
Potentiometer
Rotary type,
linear, single
turn, 1 1/4" dia.,
bushing
mounted, sleeve
bearing.

This particular little precision pot of ours meets Government specs, competitive specs and specs that haven't been written yet, but we feel none of that lifetime performance is worth anything to you unless it's *sealed in*—against smog, smoke and sweat for the life of the pot. So we seal all our pots as *standard*, and don't charge you extra, to safeguard the dependability we've built *into* the pot.

General Controls maintains forty-two factory branch offices in key cities, staffed with sales engineers who know the story on why this PRM-123 is a better pot for you. They are in the phone book. Give them a call.



GENERAL CONTROLS ELECTRONICS DIVISION

Glendale, California • Skokie, Illinois • Guelph, Ontario, Canada
Factory Branch Offices in 42 principal cities

Circle 229 Readers Service Card

by 7 in. deep. Circle 438 on Reader Service Card.

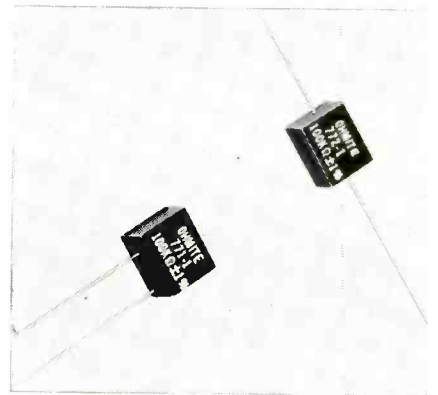

PRECISION RESISTOR

metal film type

OHMITE MFG. Co., 3661 Howard St., Skokie, Ill. A new kind of precision resistor, the Riteohm Series 77 metal film resistor, is now available.

The advanced metal film resistors were developed to meet tough, new military and industrial demands. They represent a radical departure in construction from wire wound precision resistors. Bulletin 155 gives complete information. Circle 439 on Reader Service Card.



SOLDERING AIDS

for printed circuits

CBS-HYTRON, A Division of Columbia Broadcasting System, Inc., Danvers, Mass., has introduced two miniaturized soldering aids for printed circuits. The new tools—one with straight tip, the other with angled tip—are especially designed for servicing the compact and delicate printed boards of modern miniaturized equipment.

Both tools offer features of the

NEY'S SMALL PARTS PLAY A BIG PART IN PRECISION INSTRUMENTS • NEY'S SMALL PARTS

PRECIOUS METAL

ENGINEERED CONTACTS, SLIP RINGS & ALLOYS

Ney designs and makes to customers' specifications sliding contacts, slip rings and assemblies, commutator segments and assemblies, brush and brush holder assemblies, and precious metal resistance wire. Consult Ney's Engineering Dept. and find out how precious metals can improve your products.

THE J. M. NEY COMPANY, P.O. BOX 990, DEPT. E HARTFORD 1, CONN.
Specialists in Precious Metal Metallurgy since 1812

Ney has just built this modern new plant to give you even better products and better service.

NEY'S SMALL PARTS PLAY A BIG PART IN PRECISION INSTRUMENTS • NEY'S SMALL PARTS

This is **AC** ...

... and the electronics business, including electro-mechanical devices of the most complex nature ... from Inertial Guidance Systems for supersonic missiles to Afterburner Controls for jet engines.

This is GENERAL MOTORS ...



... and all that the name implies—a solid, sound company with a policy of decentralization that offers greater opportunities for the growth of individuals within the organization.

This may be for you ...

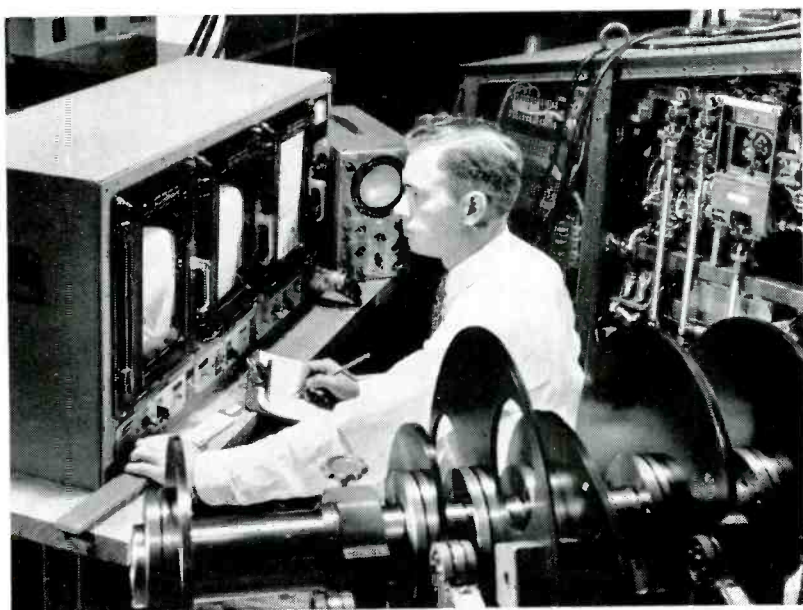

If you are a graduate engineer with an electrical, mechanical or electronic background (and 3 to 10 years experience), there is a spot for you at AC.

AC is now developing and producing Inertial Guidance Systems, Gyroscopes, Gyro-Accelerometers, Afterburner Fuel Controls, Speed Sensitive Switches, Speed Sensors, Three-way Selector Valves, Emergency Fuel Controls, Bombing Navigational Computers, Gun-Bomb-Rocket Sights, Manifold Air Pressure Regulators, and Torquemeters.

Opportunities now exist for you to work on any one of these projects, with some of the leading men in each of these fields.

If you feel AC may be the place for you, write or phone Mr. Cecil E. Sundeen, Supervisor of Technical Employment. AC ... the Electronics Division of General Motors, 1925 E. Kenilworth, Milwaukee 1, Wisconsin.

AC  THE ELECTRONICS DIVISION OF GENERAL MOTORS

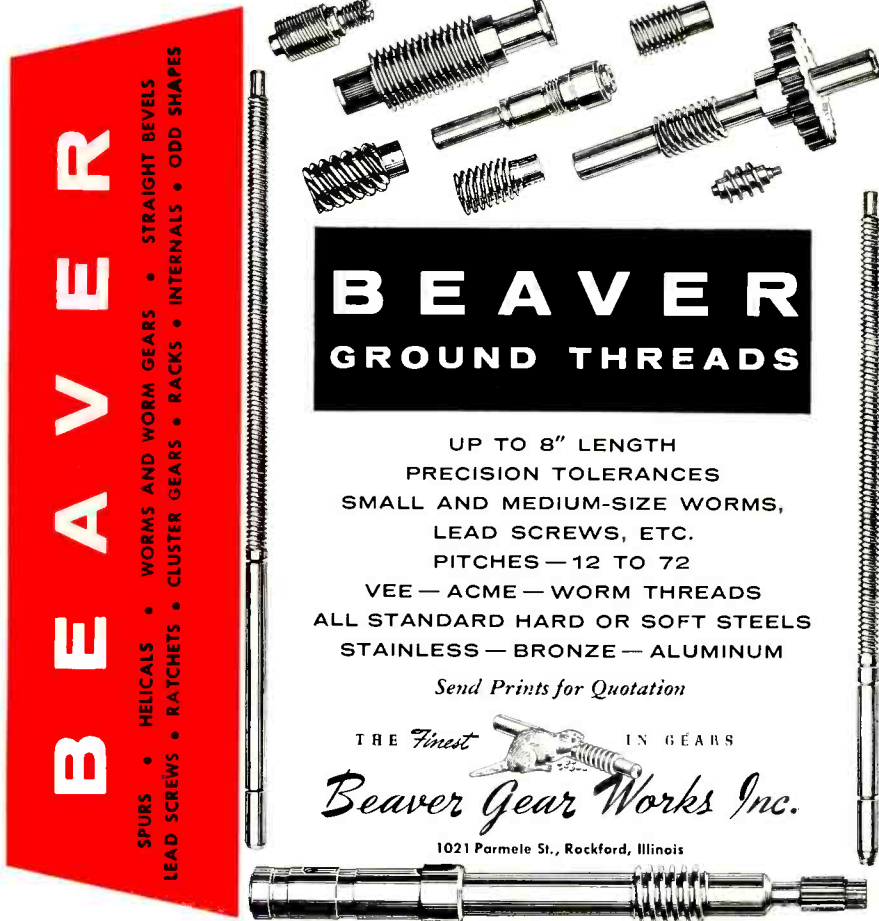

BEAVER

SPURS • HELICALS • WORMS AND WORM GEARS • STRAIGHT BEVELS
LEAD SCREWS • RATCHETS • CLUSTER GEARS • RACKS • INTERNALS • ODD SHAPES

**BEAVER
GROUND THREADS**

UP TO 8" LENGTH
PRECISION TOLERANCES
SMALL AND MEDIUM-SIZE WORMS,
LEAD SCREWS, ETC.
PITCHES — 12 TO 72
VEE — ACME — WORM THREADS
ALL STANDARD HARD OR SOFT STEELS
STAINLESS — BRONZE — ALUMINUM

Send Prints for Quotation

THE *Finest* IN GEARS
Beaver Gear Works Inc.

1021 Parmele St., Rockford, Illinois

Circle 231 Readers Service Card

original CBS standard soldering aids. The fork end easily disconnects soldered joints. The spade end reams solder from lug hole. Many other uses are possible.

Tips are of tool steel tempered to withstand heat and hard-chrome plated to shed solder. Circle 440 on Reader Service Card.

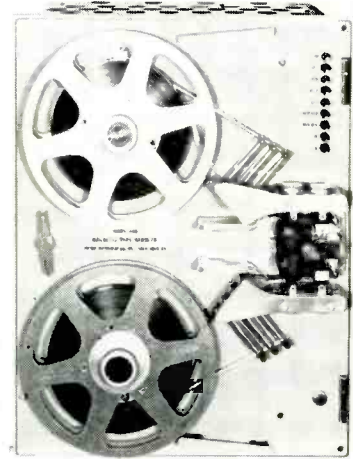
**TAPE HANDLERS**

with speeds up to 75 ips

POTTER INSTRUMENT CO., Sunnyside Blvd., Plainview, N. Y. Features of the model 905 series of digital magnetic tape handlers include tape speeds up to 75 ips with 3 millisecond starts and stops. Any tape width up to 1½ in. may be used. Other new features include fast rewind in both forward and reverse directions, dual speeds in the ratio of four to one with high speeds up to 75 ips, transparent dust cover, quick threading, and rack mounting. The transport mechanism is mounted on a hinged panel which provides immediate access to all mechanical parts and tubes. A hinged rear door provides access to all wiring connections and the remote control terminal strip.

The model 905 is automatically stopped when the end of a reel of tape approaches, when line voltage fails or drops below a prescribed minimum, or in the event of a tape failure. All machine functions, including on, off, forward, stop, reverse, forward rewind, reverse rewind, high speed

zzz-i-p! **it's cabled!**

with **ALPHLEX®**
ZIPPER TUBING
by **alpha wire**

- stock sizes ½" — 4" I.D.
- meets MIL specs
- immediate delivery

to harness wire
to custom-cable
to enclose
to protect
to replace worn jackets

*faster, better, at lower cost
strong, flexible, durable*

Write for free catalog
AZ-1 and name of
nearest distributor

ALPHLEX TUBING DIVISION
Alpha Wire Corporation
200 Varick St., N. Y. 14, N. Y.
ALgonquin 5-5400
NY-1-1152

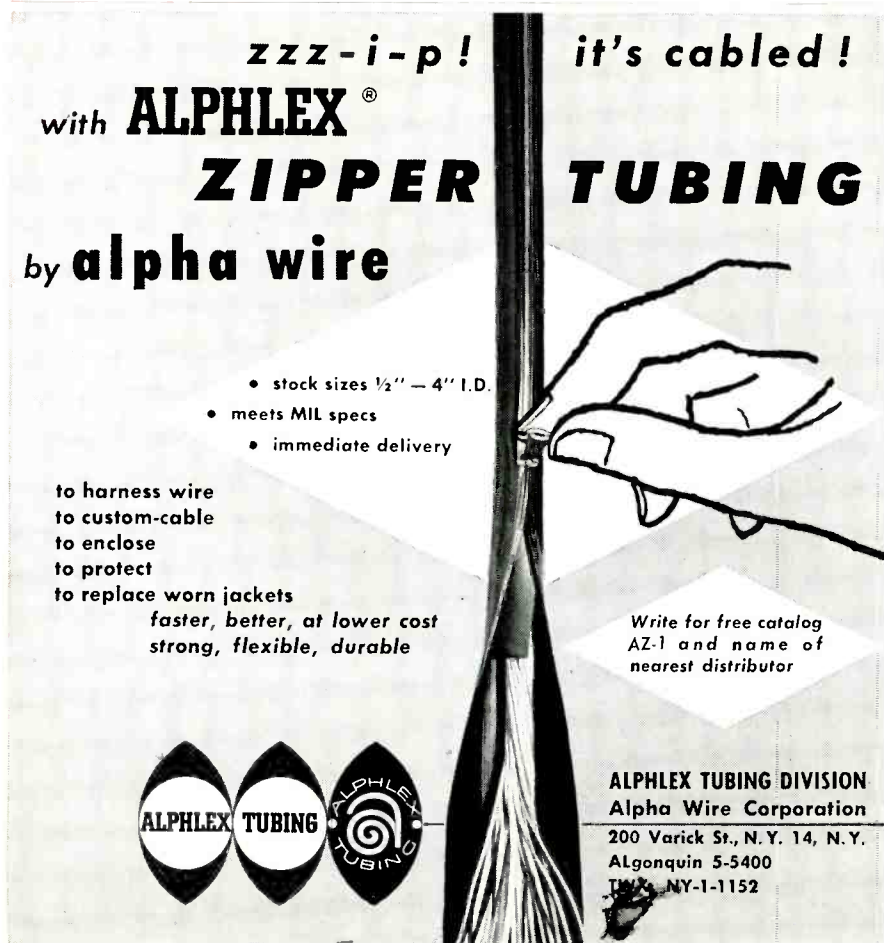

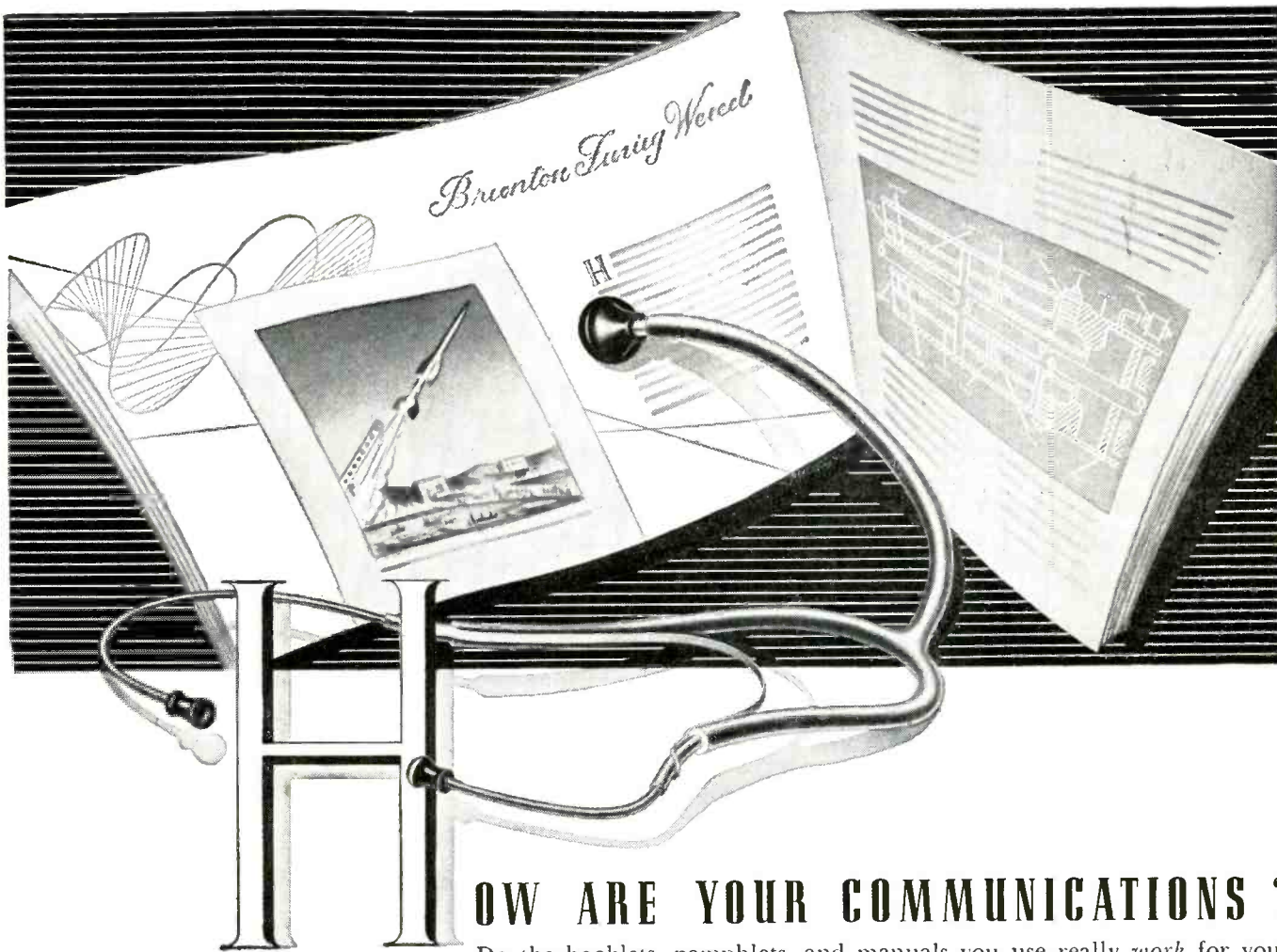

HOW ARE YOUR COMMUNICATIONS ?

Do the booklets, pamphlets, and manuals you use really *work* for you? Are these vital publications, that tell the story of your products and your company, as effective, readable, well designed and illustrated as they can be? Today more than ever, your entire operation is judged by each annual report, employee manual, and public relations piece that you produce. Have you examined your communications lately? If you have any doubt as to the impact of your instructional and promotional literature, remember . . .

COMMUNICATION IS OUR BUSINESS

For a good many decades McGraw-Hill has stood for complete coverage in the business literature field. Now the McGraw-Hill TECHNICAL WRITING SERVICE offers a new approach to your publication problems — an *integrated* writing, editing, illustrating, and printing service for the *custom* production of: INSTRUCTION MANUALS, PRODUCT BULLETINS, TRAINING AIDS, INDUSTRIAL RELATIONS LITERATURE, ANNUAL REPORTS, COMPANY HISTORIES, PROCEDURAL GUIDES and other collateral literature. More than 150 editorial and graphic experts are at your disposal, ready to prepare high-quality material to your own or government specifications. Save time, save money . . . and make your communications work! Let *our* staff be your staff for technical and business publications.

McGraw-Hill Book Co. TECHNICAL WRITING SERVICE

Write or phone Technical Writing Service, McGraw-Hill Book Co., Inc.
330 West 42nd Street, New York 36, N. Y. • LOngacre 4-3000

This service is available through ad agencies.

**RELIABLE CONTROL INSTRUMENTS
AND COMPLETE SYSTEMS —
...Daystrom Instrument Can Supply Both!**

Daystrom Instrument will develop and manufacture control equipment and systems to meet your exacting needs. Through the years we've proven the RELIABILITY of our products to every branch of the Armed Forces ... and to many of America's greatest industries. The talent, technical skills and facilities we make available to you assure a product which will meet your most critical requirements. And this goes for the development and manufacture of a complete system ... or our entry "any place along the line."



**RADAR
SET CONTROL**

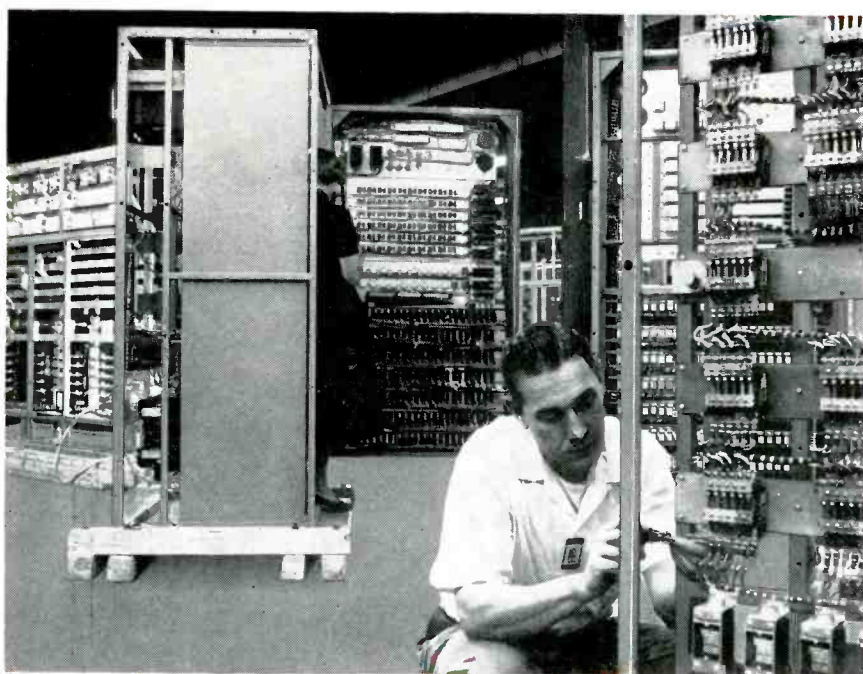

Power Control Distribution for SAGE



STEPPING SWITCH

Other products made at Daystrom Instrument include fire control systems, communications systems, test equipment, attack directors, underwater ordnance, power supplies, electronic chassis, radar, gear assemblies, servo applications, aircraft instrumentation and many other electronic and electro-mechanical products.

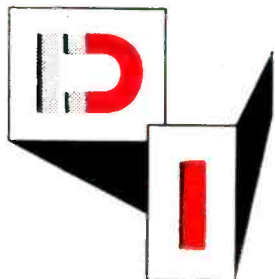

**DAYSTROM
INSTRUMENT**

Division of Daystrom Inc.

Archbald, Pennsylvania

and low speed may be controlled by conveniently grouped front-panel pushbuttons or by remote contact closures or pulses. **Circle 441 on Reader Service Card.**



PULSE RESISTOR

views current waveforms

INTERNATIONAL RESISTANCE Co., 401 North Broad St., Philadelphia 8, Pa., has announced the addition of current pulse-viewing resistors to its extensive product line.

To observe or measure the magnitude and rise times of current pulses encountered in magnetrons and other devices, a means must be provided for applying the current pulse as a signal to the deflecting plates of a cathode-ray tube. IRC's pulse resistor views current waveforms with rise times from 0.01 to 0.5 μ sec.

Noninductive resistive elements assure minimum distortion with sharp rise time presentation. The phone plug termination makes possible direct insertion into a live circuit. **Circle 442 on Reader Service Card.**

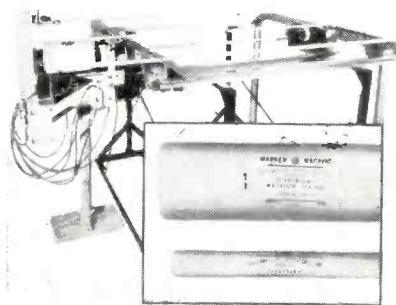

PRINTING MACHINE

marks tubular parts

MARKEM MACHINE Co., Keene 77, N. H. Rigid conduit, electrical metallic tubing and other long

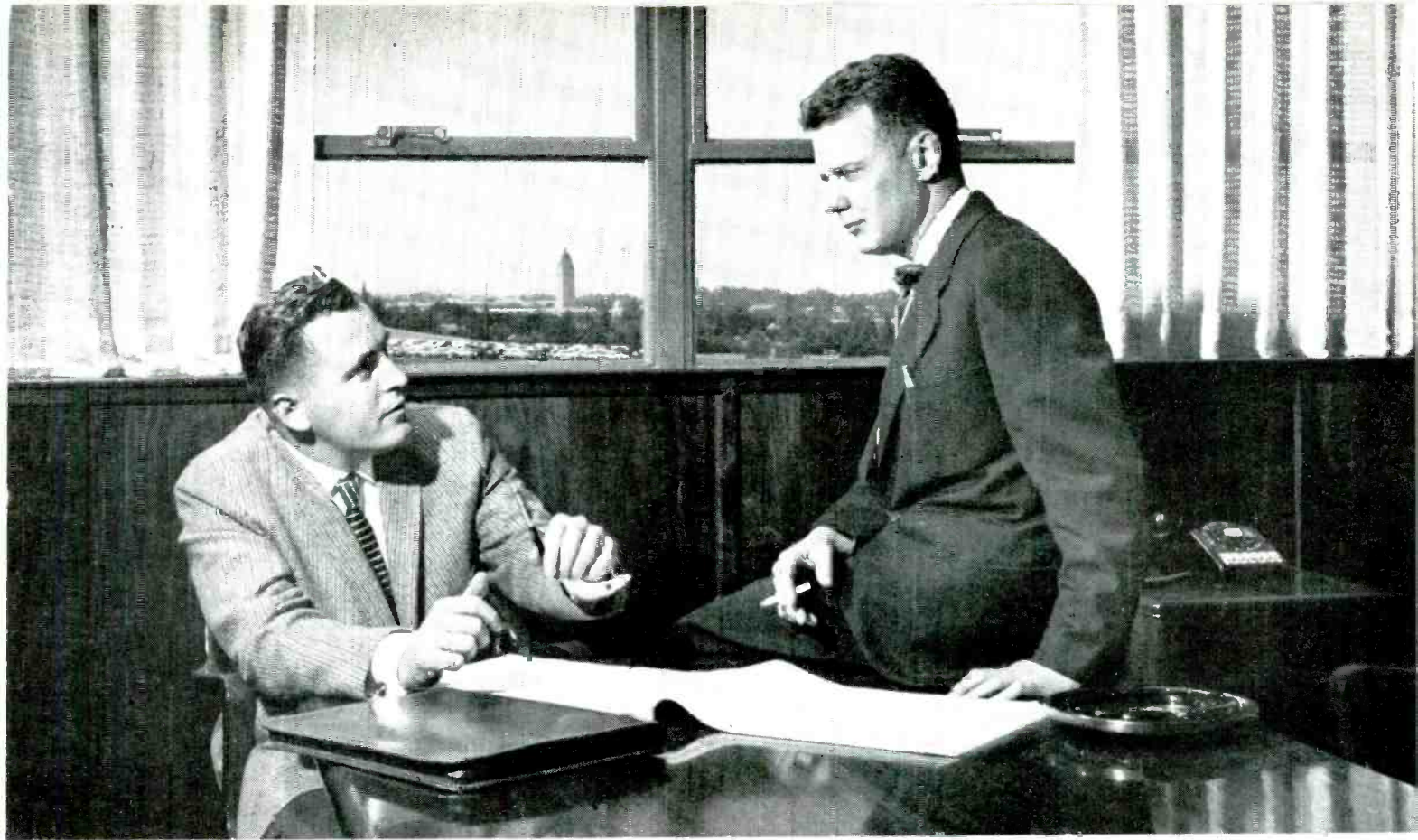

Here E. V. Stearns (left), Inertial Guidance Department Manager, and G. D. Schott, Flight Controls Department Manager, discuss preliminary design of guidance and control systems.

Lockheed Missile Systems announces...

NEW POSITIONS IN INERTIAL GUIDANCE

Few areas of science or engineering equal inertial guidance in growth or the need for continuing advances.

It is a field of major effort at Lockheed Missile Systems. Weapon systems management programs include all phases of inertial guidance and navigation.

Continued expansion in these programs has created a number of new positions, involving:

- Mechanical design of precision instruments such as gyros and accelerometers, giving extreme attention to size, weight, susceptibility to environment and related factors;
- electronics circuit design, using miniaturized and solid state techniques;
- design of precise computing systems for data handling within the guidance system;
- theoretical analysis and study of guidance problems to relate the dynamics of a vehicle in a defined flight path or trajectory to a prescribed mission or objective of the larger weapon system;
- theoretical analysis to determine performance of guidance systems and to optimize their design;
- analysis and prediction of component performance through application of theory, study and laboratory testing;
- design, development and construction of specialized testing equipment in which celestial and terrestrial motions form the basic reference for measurement;
- manufacturing development of inertial components such as gyros and accelerometers.

Those possessing a high order of ability and experience are invited to write the Research and Development Staff, Palo Alto 18, California.

Engineers who lack experience in inertial guidance but wish to participate in its growth are invited to write.



Lockheed

MISSILE SYSTEMS

A DIVISION OF
LOCKHEED AIRCRAFT CORPORATION

**PALO ALTO • SUNNYVALE
VAN NUYS, CALIFORNIA**

HIGH VOLTAGE QUALITY RELIABILITY

30 KV DC SUPPLY



A basic high quality High Voltage DC supply developed specifically for laboratory and industrial use by engineers with long experience in the high voltage field.

Controls and special features to suit your requirements are available.

Other supplies up to 200 KV, 20 KVA, in air, oil or solid insulating media, with vacuum tube or semi-conductor rectifiers.

SPECIFICATIONS

ELECTRICAL:

INPUT: — 115 volts, 50/60 cycles
 OUTPUT: — Voltage — 30 KV DC
 Current — 3 MA or 6 MA @ 30 KV
 POLARITY: — Either positive or negative high with one terminal at ground potential or center ground.

CIRCUIT: — Full wave voltage doubler.
 RECTIFIERS: — Vacuum tubes (easily replaced) or selenium rectifiers.

RIPPLE: — Less than 0.5% RMS per MA.
 INSULATING MEDIUM: — Special high grade insulating oil — to insure freedom from electrical noise.

PHYSICAL:

SIZE: — 10" x 12½" x 13" high (approx.)
 FINISH: — Gray hammertone
 HOUSING: — Heavy gauge steel tank.
 CONNECTORS:
 Input: — AN 3102A-14S-1P
 Output: — Shielded polyethylene cables.

tubular parts and products can be marked rapidly with the new Model 86A printer. Specially designed for this type of work, the 86A accepts diameters from ½ in. to 4 in. in standard 10 ft lengths, either plain or coated, and prints up to 30 pieces per minute, depending on the conduit size.

Maximum imprint area is 1½ in. from left to right along the axis of the tube, and 2 in. from top to bottom around the tube, dependent on tube area. Typical markings are the product name, trademark, grade or UL seal of approval.

Model 86A can be used as an automatic in-line unit or as a separate manually controlled machine. The machine is 36 in. long and 100 in. wide; height can be made to customer's order. Circle 443 on Reader Service Card.



DELAY LINES

feature small size

ADVANCE ELECTRONICS LAB., INC., 249-250 Terhune Ave., Passaic, N. J. A unit of type 4T series delay lines consists of 60 sections of m-derived networks. Each of these networks was especially designed to give linear phase response up to at least 70 percent of its cutoff frequency and less than 2 percent overshoot. These results are achieved by means of mutual coupling between two halves of a section, as well as mutual coupling between two adjacent sections. The amount of mutual coupling is carefully calculated and proved experimentally to be its optimum value for achieving minimum values of rise time, overshoot and ripples.

Cutoff frequency in mc equals



DEL ELECTRONICS CORPORATION

521 HOMESTEAD AVENUE • MOUNT VERNON, N. Y. • OWENS 9-3232

WE DESIGN, MANUFACTURE AND STOCK A COMPLETE LINE OF HIGH VOLTAGE TRANSFORMERS

McGraw-Hill TECHNICAL WRITING SERVICE

TWS offers you a single INTEGRATED publishing service prepared to undertake a project from research and planning through finished manuscript and art, typesetting, mechanical preparation, printing and binding. Whatever the situation, whatever the type of literature you need, our editorial and art consultants can help you, bringing to your most specialized job the craft and skill of publishing experts.

WRITING EDITING ILLUSTRATING PRINTING

TO YOUR OWN OR
GOVERNMENT SPECIFICATIONS

Whether you need an instruction book or service manual, to accompany your equipment, written to government specifications . . . or product catalogues or training booklets . . . or annual reports . . . or company histories . . . our writing staff can do the job for you, our artists can create and execute the illustrations. And McGraw-Hill printing, binding, and paper resources are among the best in the country.

SAVE MONEY AND TIME
LET OUR STAFF BE
YOUR STAFF FOR
TECHNICAL and BUSINESS
PUBLICATIONS

ASK
OUR REPRESENTATIVE
TO CALL

Write • Phone

Technical Writing Service
McGraw-Hill Book Co., Inc.
330 W. 42nd St., N. Y. 36, N. Y.
LOngacre 4-3000

IMMEDIATE DELIVERY

(Small Quantity)

Precision Carbon Deposited Resistors

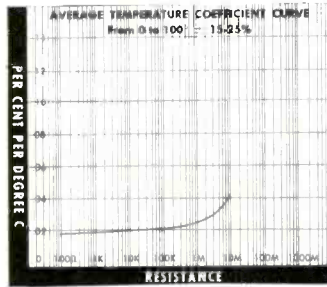

Temperature coefficient characteristics for ALPT-1 watt resistor

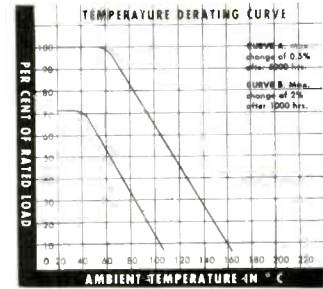

Derating curve for ALPT-1 watt resistor

STANDARD RESISTORS $\pm 1\%$ TOLERANCE IN 10% RMA
VALUES FROM 10 OHMS TO 2.7 MEGOHMS

APST- $\frac{1}{2}$ WATT, APXT- $\frac{1}{2}$ WATT AND APCT-1 WATT
SALES OFFICES AND DISTRIBUTORS

Factory Delivery, other than stock values:
1/10, 1/5, 1/4, 1/2, 1, 2 and 5 Watt

ALLIES' PRODUCTS CORPORATION
P. O. Box 188, Kendall Branch, Miami, Florida

BROCHURE SUPPLIED UPON REQUEST.

Circle 325 Readers Service Card

TRANSFORMERS FOR ELECTRONICALLY REGULATED POWER SUPPLIES

Now . . . over the counter

Avoid delay in making your breadboards,
no waiting for a special when a

STERLING 2K SERIES

transformer will meet your requirements exactly.
Stock STERLING 2K units are available for supplies
from 100 milliamperes at 100 volts
to 400 milliamperes at 300 volts

Each 2K transformer provides:

- PLATE VOLTAGE ALLOWANCE FOR PASS TUBE VOLTAGE DROP 570-0-570V 240 mac*
- RECTIFIER FILAMENT POWER 5.0V 3 A
- PASS TUBE FILAMENT POWER 6.3V 3 A
- REGULATOR CIRCUIT FILAMENT POWER 6.3V 1.2A
- AUXILIARY FILAMENT POWER FOR OTHER CIRCUIT REQUIREMENTS 6.3VCT 6 A
- REGULATOR CIRCUIT PLATE POWER *Note 40 ma provided
- APPLICATION BULLETIN WITH EACH UNIT

Military versions of each of these units is also available. Technical data on the complete line is available on request.

SAMPLES?
SPECIALS?
SHORT RUNS?

The 2K series is only one of the many types we make. We specialize in custom-built transformers to your specifications. Let our engineering staff help solve all your transformer problems.

Samples delivered in 1 to 3 weeks.



Technical specifications on a typical unit of this family of transformers for use in a 300 volt 200 milliampere dc regulated power supply with 90 to 130 V AC input:

ST2010
Primary:
115 Volts AC, 50 to 1000 cps

Secondaries:
570-0-570V 240 mac*
5.0V 3 A
6.3V 3 A
6.3V 1.2A
6.3VCT 6 A

*Note 40 ma provided
Size: 5 1/8 x 4 5/8 x 5 1/2 H
Mtg. Centers: 3 1/2 x 3 1/2
Weight 15 lbs.
Associated Choke: ST2009
4 Henries at 240 macd.

STERLING

TRANSFORMER
CORPORATION

299 North 7th St., Brooklyn 11, N. Y.
STagg 2-4200

Circle 326 Readers Service Card

THERMAL DESIGN PROBLEMS?

(Here's big news about thermally stable Hymu "80" laminations)

EUREKA! THIS IS IT!.. WE WILL CALL THEM THERMALLY STABLE LAMINATIONS!

FROM -55°C TO +85°C THEY REMAIN STABLE AND NO OTHER LAMINATION CAN MAKE THAT STATEMENT!

ORDINARY LAMS → THAT'S US! → **CURVES SHOW 1/3 OF THE VARIATION IN THIS MATERIAL COMPARED WITH REGULAR HYMU "80"!**

YEP! USE THERMALLY STABLE LAMINATIONS WHERE HIGH PERMEABILITY MUST REMAIN CONSTANT OVER A WIDE TEMPERATURE RANGE

USE 'EM FOR ROCKETS OR ANY OLD THING!

WE ASKED 4,852 TOP ENGINEERS AND GUESS WHAT WAS MOSTLY ON THEIR MINDS?...

THERMALLY ACTIVE COMPONENTS

WE HAVE MORE INFORMATION FOR YOU!.. JUST ASK US!

Magnetic Metals Company is processing Hymu "80" transformer laminations which will remain stable at temperatures from -55°C to $+85^{\circ}\text{C}$. Core designers will find of great value the combination of thermal stability and reliable high permeability at low density. Laminations for a variety of applications are available in this material.

MAGNETIC METALS COMPANY



ELECTROMAGNETIC CORES and SHIELDS
HAYES AVENUE AT 21st STREET • CAMDEN 1, N. J.

NEW PRODUCTS

(continued)

19.2 divided by D , where D is the total time delay of the delay line in μsec . The rise time is less than 5 percent of the time delay. Accuracy of the time delay is ± 2 percent. Physical size is $3\frac{1}{2}$ in. by 3 in. by 6 in.

There are more than 50 types available for this series. The total time delay can be made any value from $0.3 \mu\text{sec}$ to $60 \mu\text{sec}$. The impedance can be made any value from 50 ohms to 2,000 ohms. Circle 444 on Reader Service Card.

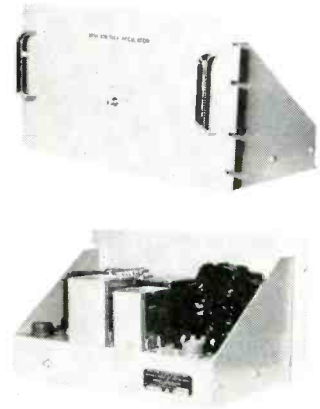

VOLTAGE REGULATOR

all-magnetic, tubeless

MAGNETIC RESEARCH CORP., 3160 West El Segundo Blvd., Hawthorne, Calif. An all-magnetic, tubeless, 3 kva a-c line voltage regulator for use in 115-v, 400-cycle single-phase and 3-phase military ground support and laboratory equipment is now available.

Designated MRC part number 75-113-0, the unit maintains a constant 400-cycle a-c line voltage regardless of line or load variations. It insures proper operation of precision equipment where changes in a-c voltage could cause malfunctioning or loss of accuracy. Three of the single-phase units can be connected for three-phase operation, delivering a total of over 5 kva.

Regulation is held within ± 0.5 percent against line changes between 100-130 v, load changes from 2.5-25 amperes, and frequency changes between 380 and 420 cps. Response time is less than 20 milli-sec. Output wave form distortion is 5 percent maximum. With out-

Only a few
Proceedings
of the IRE
special issues

are still available Each issue of *PROCEEDINGS OF THE IRE* is the result of the most advanced thinking in the field of radio-electronics. Based on exacting research, and written by men who are foremost in their specialty, these issues are invaluable works of reference. This is also material not available from any other source. As the official publication of *The Institute of Radio Engineers*, *PROCEEDINGS* presents the years-ahead ideas on which new advances are based. These history-making issues, originally over-printed for reserves are rapidly being exhausted and will not be reprinted.

YOU CAN STILL GET:

VERY LOW FREQUENCY, June, 1957 — New research in the very low frequency band, below 30 kc., opens up greater portions of the radio spectrum for communication purposes. VLF has many new and important uses. A reference work you'll need for years.

SINGLE SIDEBAND, December, 1956 — A round-up of recent technical discoveries as presented by the Joint Technical Advisory Committee through its sub committee on Single Sideband techniques. This special study for the FCC points up the many advantages of single sideband.

FERRITES, October, 1956 — This new group of solid state materials outmodes the intermittent "pulse" system of World War II radar. The ferrites allow simultaneous sending and receiving on a single microwave antenna; as well as full-power transmission in microwave ranges with reduced power loss and interference.

SOLID STATE ELECTRONICS, December, 1955 — This issue heralds the arrival of a new epoch in radio electronics — the solid state electronics era. Defined and named with the birth of the transistor, this concerns the control and utilization of the electric magnetic and photic properties of solids. There are now whole new classes of electronic devices due to discoveries in this field.

SCATTER PROPAGATION, October, 1955 — Here's radio history in the making. This issue presents practical application of a new principle in the fields of broadcasting and electronics. Thirty-five papers lay the foundation of a new means of communicating over long distances.



The Institute of Radio Engineers
 © 1 East 79th Street, New York 21, N. Y.

Please send me the following issues of *PROCEEDINGS OF THE IRE*:

Enclosed is my check for \$ _____ *

Enclosed is Company Purchase Order

Name _____

Company _____

Address _____

City _____ State _____

*One copy at \$1.25 to IRE members, domestic and foreign. \$3.00 to non-members; \$2.40 to public libraries, colleges and subscription agencies; postage prepaid to U. S. and Canada; 25c additional per copy to other countries.

PHILCO®

REGISTERED TRADEMARK OF PHILCO CORPORATION

uses **ERIE "PAC"**
in its newest
TV models

to...

**LOWER
PRODUCTION
COSTS**

**REDUCE
INVENTORY**

**CUT DOWN
CHASSIS AREA**

**SPEED
ASSEMBLY**

**SIMPLIFY
INSPECTION**

**REDUCE
INSERTIONS**

**REDUCE
PUNCHED HOLES**

**ELIMINATE
ASSEMBLY
EQUIPMENT**

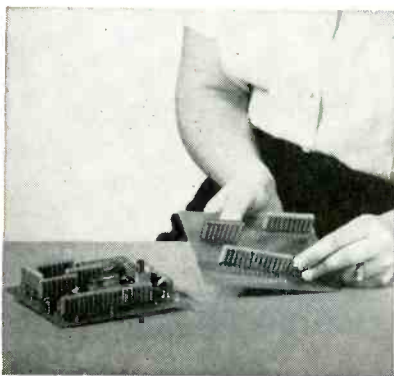

The ERIE Pre-Assembled Components system, known as PAC, is a custom designed module containing standard resistors and capacitors mounted to a printed wiring board. Other manufacturers of many types of electronic equipment are taking advantage of similar benefits of lower production costs and more compact chassis assemblies by the employment of PAC's. Our engineers will be glad to consult with you about incorporating PAC in your equipment.

ERIE

Electronics Division

ERIE RESISTOR CORPORATION

MAIN OFFICES: ERIE, PA.

FACTORIES: ERIE, PA. • HOLLY SPRINGS, MISS. • TRENTON, ONTARIO, CANADA

NEW PRODUCTS

(continued)

put voltage continuously adjustable between 110 and 120 v, the most desirable output of 115 v lies in the center of the adjustment range. The unit is particularly useful to provide independently regulated 400 cps power for individual laboratories which are fed from a common 400 cps supply.

All magnetic components of the regulator are designed to meet MIL-T-27A specifications. Use of rugged, long-life magnetic amplifiers instead of tubes assures high reliability and long service in unattended locations. The unit is maintenance-free. It is short-circuit protected and cannot produce dangerous output overvoltages. Circle 415 on Reader Service Card.

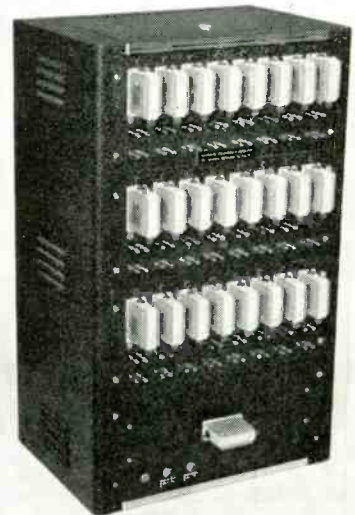

DRY CIRCUIT TESTER checks relays

FLEETWOOD LABORATORIES INC., 300 Victory Blvd., New Rochelle, New York, has available relay test sets that pass low-current, low-voltage signals through the contacts of relays to be used for grid switching applications while the relays are energized. Individual contacts can be monitored for research into the dry circuit phenomena or all contacts can be connected in series for production lots. Model R-3C passes 30 μ a through the contacts with an open circuit voltage of 30 mv. Model R-4C passes 1 μ a through the contacts with an open circuit voltage of 5 mv. Models with adjustable sensitivity, over

a wide range of test conditions, are also available.

The test relay is energized once per second and a counter records the number of times a failure is encountered. Test sets of various sizes are available to test from 1 to 24 relays simultaneously. Circle 446 on Reader Service Card.

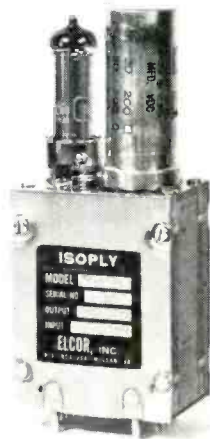

POWER SUPPLY

isolated miniature type

ELCOR INC., P. O. Box 354, McLean, Va. Model 4150-10A Isoply is the second in a series of new isolated miniature power supplies, featuring very low shunt capacitance from d-c output to ground. A novel transformer construction and special mounting of the rectifiers and filter circuit elements allows the entire secondary circuit to be capacitively as well as conductively isolated from ground. The low value of shunt capacitance (20 μmf) makes the supply suitable for use in a wide variety of high-speed direct-coupled circuits that require an ungrounded power supply. The Isoply is also very useful wherever bootstrapping is needed, as in pentode cathode followers and certain sweep generators. A leakage resistance in excess of 100,000 megohms and voltage breakdown exceeding 2,500 v are features that make the supply useful in special applications.

Model A150-10A features a regulated 150 v output conservatively rated at 10 ma maximum current. Maximum ripple is less than 0.01 v. The unit operates directly from 110-125 v, 60 cycles a-c. Dimen-

STABILITY

3%

MAXIMUM CAPACITY CHANGE over temperature range +10° to +85°C (Z5E) on this proven Hi-K dielectric.

ERIE TYPE "H-A" TEMPERATURE STABLE Hi-K DISC CERAMICONS®

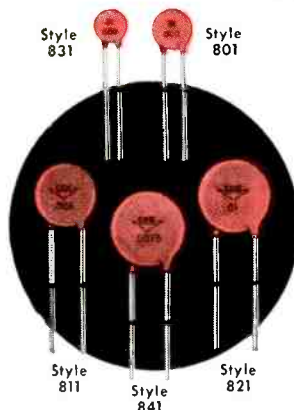
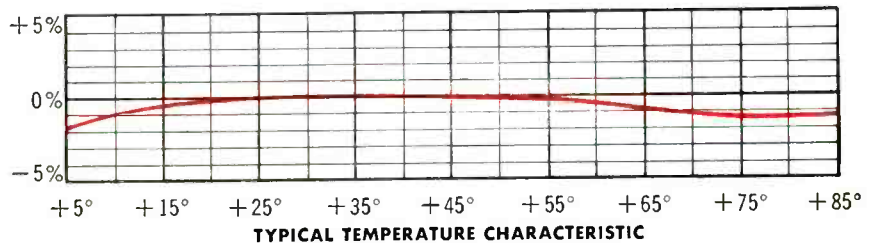

For further information write for ERIE Bulletin 449.

ERIE's continued basic laboratory research in Ceramics results in an outstanding Hi-K ceramic . . . ERIE TYPE "H-A". This dielectric exhibits the flattest temperature characteristic Hi-K material ever offered to industry.

TYPE "H-A" Temperature Stable Ceramicons are available in production quantities in any nominal capacitance value ranging from 150 mmf. to 4,250 mmf. with tolerances of $\pm 10\%$ and $\pm 20\%$. Diameters of the "H-A" Ceramicons range from $\frac{5}{16}$ " to $\frac{3}{4}$ ". Available in 22 gauge wire leads; also with 20 gauge wire leads or spade leads for insertion in printed circuit boards.

Because of their small size and convenient shape, the TYPE "H-A" disc is ideally suited for critical applications that formerly required the use of expensive capacitors of other types, and is an excellent replacement for paper and mica capacitors.

ERIE DISCS AVAILABLE IN 3 TYPES

TEMPERATURE COMPENSATING ERIE Disc Ceramicons offer a wide combination of temperature coefficient and capacitance values. They meet all requirements for RETMA REC-107A Class 1 ceramic capacitors. Available in capacity ranges from 1.5 to 2810 mmf. at 500 V.D.C.W. and temperature coefficients ranging from P120 through N5600.

GENERAL PURPOSE ERIE Disc Ceramicons have low series inductance which assures efficient high frequency operation. Values from 1.5 mmf. to .02 mfd. Rated at 500 Volts D.C. Working.

HIGH VOLTAGE ERIE Disc Ceramicons use the same basic design that have been standardized in 500 Volt ratings. Available in 1 KV thru 4 KV, based on 1,000 hr. 85° C life test at $1\frac{1}{2}$ times rated voltage.



SEE and MEASURE pressure distribution

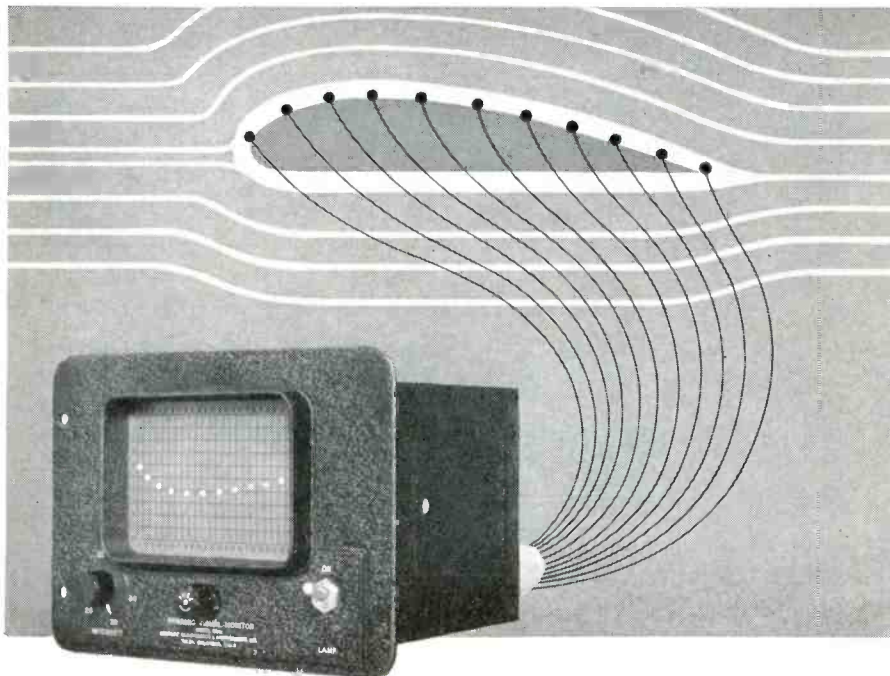

with CENTURY Model 20 VISUAL MONITOR

Visual presentation of airfoil pressure distribution is achieved by a major airframe manufacturer by means of the Century Model 20 Dynamic Visual Monitor.

By dynamic bargraph display, simultaneous observation of 24 pressure-transduced signals is permitted throughout an extended range of frequencies. Variations in pressure gradient, peak pressures, as well as oscillations associated with sonic flow phenomena are thus presented in continuous analog form.

Information presented by the Monitor permits a high degree of selection of those data for permanent recording by conventional tape or recording oscillograph process. With such discretion available, the great savings in data reduction time becomes apparent.

The Monitor provides a display of the focused light beam from as many as 24 pencil-type galvanometers on a calibrated viewing screen, 2.5" high x 4.0" wide. Galvanometers, flat in range of 0 to 42 cps with sufficient deflection sensitivity for direct coupling to most transducers are available. Other galvanometers are available for use in the region of 0 to 240 cps.

Monitoring of temperatures throughout a system or along a given piece of material, monitoring of vibration, flow, colorimetry and current are also vital applications of the Monitor.

Century Electronics & Instruments, Inc.

1333 No. Utica, Tulsa, Oklahoma

NEW PRODUCTS

(continued)

sions are 1½ in. wide by 2¼ in. long by 5½ in. high. Circle 447 on Reader Service Card.

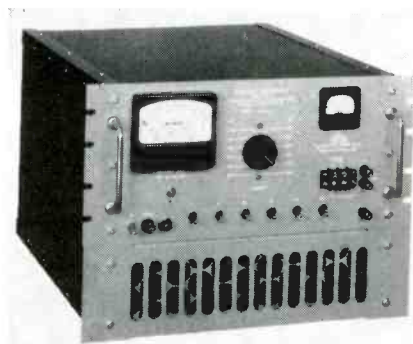

CURRENT GOVERNOR is a transistorized unit

NORTH HILLS ELECTRIC Co., INC., 402 Sagamore Ave., Mineola, N. Y. Model CG12 "Current Governor" offers many firsts through transistorized current stabilization. It is a two terminal current stabilizer, modulator and electronic load. Completely transistorized, the CG12 features front panel control for selection of current levels in 50-ma steps from ½ to 30 amperes. The stabilized current may be modulated 0-100 percent by external signals including sine wave, complex waveforms and d-c.

Together with its primary applications for constant current generation, and as a programmable electronic load, the versatile CG12 may be excellently applied to diode testing, transistor testing, magnetic core investigation, fuse testing, battery testing and wherever a modulated stabilized current is required. Circle 448 on Reader Service Card.

TRANSMITTER extends telemetering range

TEXAS INSTRUMENTS INC., 6000 Lemmon Ave., Dallas 9, Texas. A new 200-w transistorized p-m transmitter has been announced which increases substantially the effective range of f-m/telemetering. The new equipment is complete in a single unit, requiring no amplification of the output. It is smaller and lighter than presently

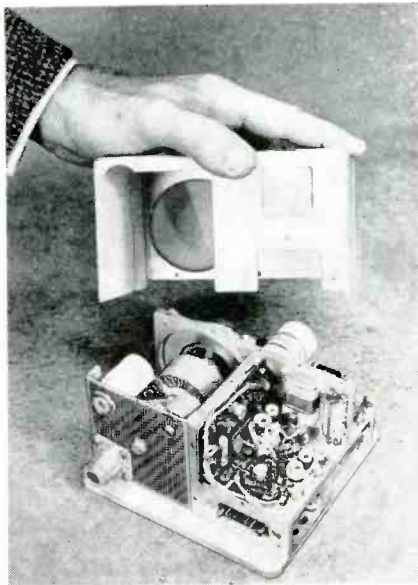

available 50-w transmitters for similar duty, occupying only 67 cu in.

The new units transmit in the 215-235 mc range with frequency stability of ± 0.01 percent up to 71 C. Higher frequencies are possible with only minor modifications. The basic unit also can be modified to operate at power outputs as low as 25 w. Operation at 200 w requires 12 cfm external cooling air. Integral "heat sink" provisions are ideally suited to missile requirements and stretching out the transmitter's operation during periods of rapid heat build up. High temperature silicon transistors are used in the oscillator, phase modulator, video amplifier, and frequency doubler circuits. The output stage utilizes a stacked ceramic tetrode with considerable excess capacity, and tubes are also used as drivers and multipliers. **Circle 449 on Reader Service Card.**

X-Y RECORDER

with 0.25 percent accuracy

THE BRISTOL Co., Waterbury 20, Conn., has announced a new electronic Dynamaster X-Y recorder. The new strip-chart recorder will automatically plot a continuous-curve showing the relationship of one measured variable to another.

Some typical uses for the instrument included plotting temperature versus pressure in the process industries, position of intake parts versus gas flow in wind

LEACH

SOLVES RELAY ENVIRONMENTAL PROBLEMS

Unique Balanced-Armature Relays meet all requirements of the most exacting operating environments — shock, acceleration, vibration and high temperatures.

In the Leach Balanced-Armature Relay, shock and vibration forces cannot move the relay armature. This eliminates faulty operation of contacts during extreme vibration and acceleration.

These Leach Relays meet or exceed requirements of MIL-R-5757, MIL-R-6106, MIL-E-5272. Typical ratings include: vibration, 20 G's to 500 cps (higher ratings available); shock and acceleration, more than 50 G's; temperature, -50° to $+125^{\circ}$ C; life, 50,000 continuous operations minimum at rated load; available 28 vac, 115 vac, 400 cps operation. At right is Leach 9226, 1.49x1.49x1.68 inches.

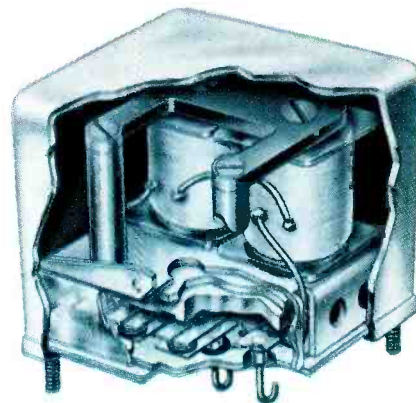

Leach has gained a unique reputation for creating reliable relays, *custom-tailored* to solve specific circuitry problems. Write for your copy of the Leach Balanced-Armature Relay Catalog.



LEACH CORPORATION

LEACH RELAY DIVISION

5915 Avalon Blvd., Los Angeles 3, California

District Offices and Representatives in Principal Cities of U. S. and Canada

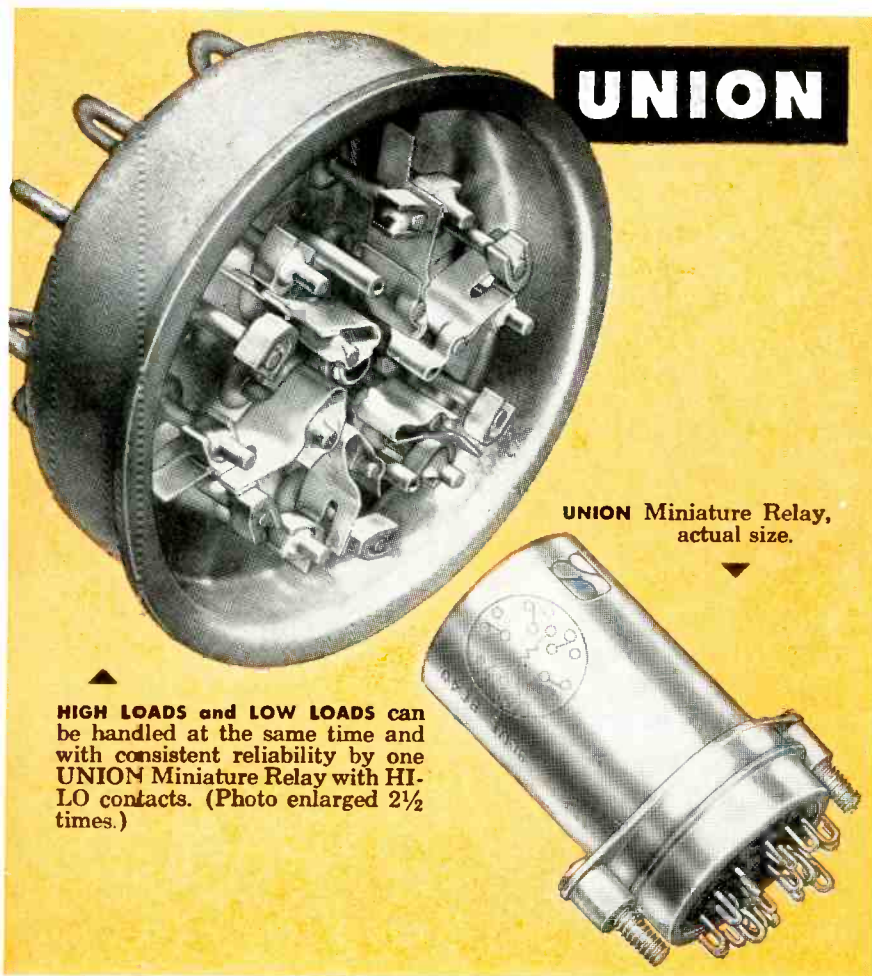

UNION

UNION Miniature Relay,
actual size.

HIGH LOADS and LOW LOADS can be handled at the same time and with consistent reliability by one UNION Miniature Relay with HI-LO contacts. (Photo enlarged 2½ times.)

New HI-LO Contacts make one UNION Relay do two jobs!

Now you can use *one* UNION Miniature Relay for both high-level and low-level circuits. A new contact material handles high loads of two amperes or low dry-circuitry loads with consistent reliability. Formerly, two separate relays were required for these applications.

The new HI-LO contact material provides optimum contact resistance for both high-level and low-level

loads. This means you can frequently save the cost of buying two different types of relays . . . and inventory expenses are much less.

You can get all standard UNION 6-pole and 4-pole Miniature Relays with HI-LO contacts. They meet or exceed specification Mil-5757-C and are available in DC or AC models. Write for Bulletin 1012 on UNION Miniature Relays.

UNION SWITCH & SIGNAL

DIVISION OF WESTINGHOUSE AIR BRAKE COMPANY

PITTSBURGH 18, PENNSYLVANIA

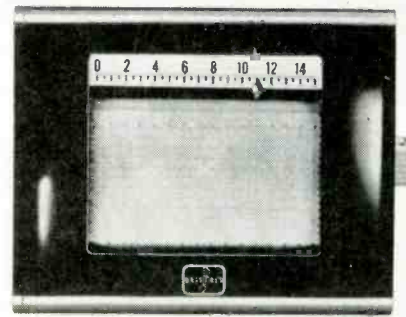

tunnel research, location on web versus thickness in paper making, and speed versus torque in motor operation. Most other variables can also be handled.

The Dynamaster records on a 12-in. strip chart, and is available in pen speeds of up to 0.4 sec for full scale traverse to follow the most rapidly changing variables. Circle 450 on Reader Service Card.

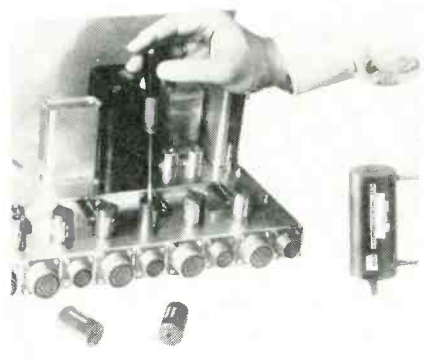

WIRE WOUND RESISTOR adjustable precision type

EASTERN PRECISION RESISTOR CORP., 675 Barbey St., Brooklyn 7, N. Y., announces Comp-U-Trim 113, an adjustable precision wire wound resistor, totally encapsulated to surpass all applicable MIL Specifications.

It is a precise trimming potentiometer embedded within the body of precision wire wound resistor. Similar temperature coefficient wire is used for both the main and trimming sections. With values up to 1.5 megohms, Comp-U-Trim 113 can be adjusted to 0.1 percent of the nominal value and trimmed to 0.001 percent. Special temperature coefficients and wider trimming variations are available on request. No. 20 Awg tin copper

leads can be specified for printed circuit applications. Circle 451 on Reader Service Card.



COORDINATE CONVERTER new analog computer

DYNALYSIS DEVELOPMENT LABORATORIES, INC., 11941 Wilshire Blvd., Los Angeles 25, Calif. Model 8-1101 high precision target acquisition computer is a special purpose unit which accepts d-c voltage representing X, Y, and Z coordinates and automatically performs transformation to azimuth angle, elevation angle, and slant range. Also available as an output signal is geographic range.

The computer, a completely self-contained unit, includes ten Dynalysis model 5-1103 computing amplifiers and four model 3-1030 servo resolvers. Total dynamic and static errors are less than one degree. Circle 452 on Reader Service Card.



PUNCHED CARD READER used with control systems

THE PEERLESS ELECTRIC Co., Electronics Division, Warren, Ohio. A static punched card reader designed for use with industrial



Digital Indicator (left) can display a possible 16 characters and is about half the size of the alpha-numerical Indicator (right) which displays 64 characters.

UNION INDICATORS

for Data Display Storage and Transfer

UNION Digital and Alpha-numerical Indicators are electro-mechanical, D.C.-operated readout devices for displaying characters in accordance with a predetermined code. The character display may be made to suit the users' requirements.

Indicators are designed for plug-in mounting in a row so that data or messages of any desired length can be stored, displayed or transmitted at will. The indicators can be applied to the output of digital computers, teletype receiving equipment in conjunction with a buffer storage unit, telemetering systems, or wherever data needs to be displayed.

An important feature of these indicators is their inherent storage and transmitting characteristics, which provide for data entry and

retransmission. The indicators can be used to accept data from a source, free the source for other programs, and disseminate the data from one indicator to another as required.

Two interesting applications: The Alpha-numerical indicator is being used in data display equipment for flight control built for CAA wherein data enters the system by keyboard or via teletype at 60 words a minute, or from magnetic drum storage at speeds up to 1000 words per minute.

The Digital Indicator is being used in pipeline remote control systems, for displaying and storing telemeteral data such as temperature, pressure, flow, etc. in a central office. Write for Bulletin No. 1011 for further information.

UNION SWITCH & SIGNAL
DIVISION OF WESTINGHOUSE AIR BRAKE COMPANY

PITTSBURGH 18, PENNSYLVANIA

TERMALINE COAXIAL LOAD RESISTORS

NEW PRODUCTS

(continued)

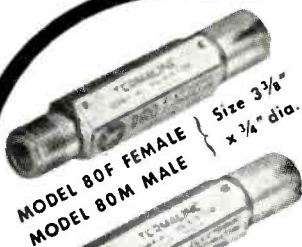

MODEL 80F FEMALE } Size 3 3/4"
MODEL 80M MALE } x 1/4" dia.

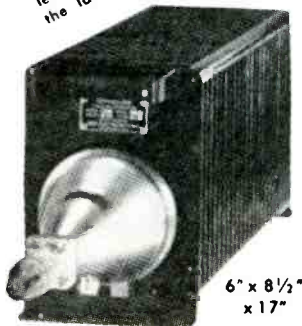

VERY HANDY in lab and production test. At signal generator levels and below 5 watts, this is the last word for low VSWR.

MODEL 82

6" x 8 1/2" x 1 7/8"

50 ohms DC to 4000 mc—5 watts to 2500 watts

The constant resistance (Low VSWR) of the TERMALINE resistor make it the ideal dummy load and standard resistor at UHF and VHF Design is such that normal reactance is put to work producing a pure resistance over an extremely wide frequency range. Acting as a "bottomless pit" for RF energy, thousands of TERMALINE units are in daily use in high frequency applications.

Model	Cont. Power Rating	Input Connector
80F	5 watts	UG-23B/U
80M	5 watts	UG-21B/U
80A	20 watts	UG-23B/U
81	50 watts	UG-23B/U
81B	80 watts	UG-23B/U
82	500 watts	} Adaptor to fit UG-21B/U supplied
82A	500 watts	
82C	2500 watts	

Adaptors or cable assemblies for standard coaxial line available.

ALL TERMALINE units, except Model 82C, are self-cooled. Substantial quantity discounts.

LITERATURE UPON REQUEST

processing and control systems is now manufactured.

The card reader accepts an IBM or any other standard punched card having as many as 80 vertical columns with 12 punching positions in each column. The reader is equipped with Cannon Connectors for connection to associated control equipment.

As a punched card is put into the reading slot, rollers automatically place it in reading position. A signal light indicates the unit is "sensing" the card. An spdt switch automatically activates associated equipment.

When the card is no longer needed, it is ejected either manually or automatically. Cards inserted upside down are ejected immediately.

The company offers standard readers with four bottom plate configurations and a top plate having up to 690 electrically insulated connecting points. Unit dimensions are 15 by 16 by 6 in.; weight is 36 lb. Specification bulletin BR-7A gives full description and schematic drawings. Circle 453 on Reader Service Card.



**BIRD
ELECTRONIC CORP.**
1800 EAST 38TH ST., CLEVELAND 14, OHIO
TERMALINE Coaxial Line Instruments

VAN GROOS
COMPANY
Sherman Oaks, Cal.

Circle 242 Readers Service Card

Metallurgists... and Specialists in Small Wire

BASE METAL WIRES . . . Very small diameter — for filaments, thermocouples, resistance units.

PRECIOUS METAL WIRES . . . Produced in Platinum, Gold, alloys and pure metals — small diameter . . . Platinum alloy resistance wires.

COATED WIRES . . . Comprising an extensive range of electroplated grid wires . . . Enamel insulated wires for precision resistors and potentiometers.

ANODIZED ALUMINUM WIRE . . . Insulation at 800°F. Precision drawn to close resistance in the smaller sizes

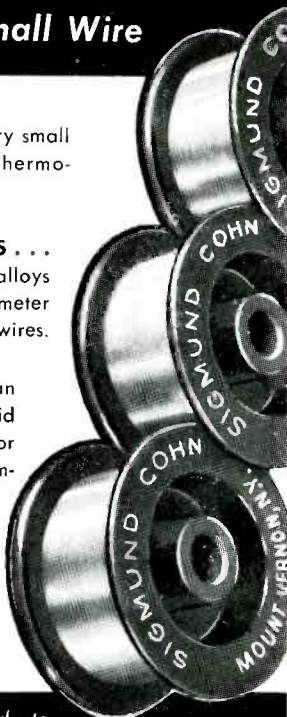

Write for List of Products

SIGMUND COHN CORP.

121 SOUTH COLUMBUS AVE., MOUNT VERNON, N. Y.



DELAY LINES

measure 4 1/4 x 4 1/4 x 1 1/4 in.

CONTROL ELECTRONICS Co., Inc., 1925 New York Ave., Huntington Station, N. Y., offers a new series of miniature variable delay lines in a large selection of total delays and characteristic impedances.

Typical of this series is model V-203, which has a 0.5 μsec total delay and 580 ohm characteristic impedance. At full delay its rise time is 0.035 μsec and attenuation



Serving
Industry
for Over
56 Years



Since 1901

0.5 db. The delay is selected by a 60-position shorting-type rotary switch. The shorting feature provides an intermediate delay of one-half step so that the resolution is one part in 120. The switch has been tested mechanically for a quarter-million cycles of operation with no signs of wear. Delays up to 10 μ sec and impedance up to 5,000 ohms are possible. Circle 454 on Reader Service Card.



SAMPLING SWITCHES high speed devices

GENERAL DEVICES, INC., P.O. Box 253, Princeton, N. J. announces a precision switch having miniature multipin connectors attached to cables of convenient length, designed for military and commercial applications.

Up to five poles with 60 shorting (make before break) channels or 30 nonshorting (break before make) channels per pole, the switch is equipped with the company's exclusive constant force perma brushes and lifetime semi-molded contact plate for long service free life. All poles are locked in precise phase relationship.

The special construction of the switch affords replacement of all brushes in a matter of minutes without force or phase adjustments. The cover plate is easily removed for inspection of the brushes and contacts. Both of the two rotors and all brushes may be replaced as a unit. The switch is easily adapted to a variety of motor drives and is equipped with a precision machined ball bearing output shaft. Approximate dimensions as shown are 3.488 in. in diameter by 3.480 in. in depth.

Typical applications include airborne and shipboard oscilloscope displays, stabilization of groups of

Kinney®

VACUUM

PRESCRIBED FOR YOUR PROJECT

A new tool for the researcher as well as manufacturers of transistors and semi-conductors of all types . . . the standard KINNEY Crystal Growing Furnace.

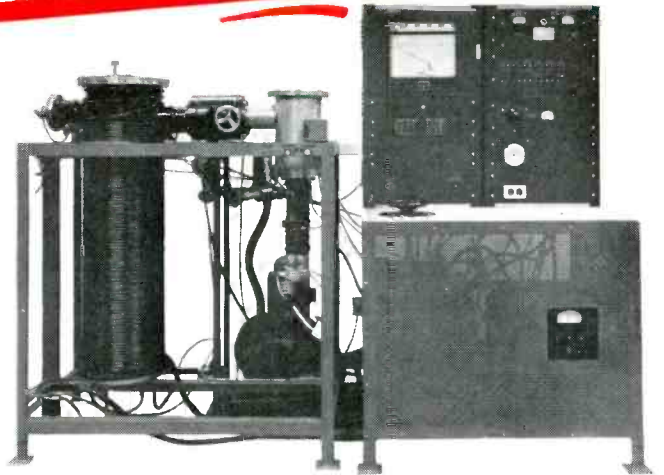

Advances in High Vacuum equipment and technology are significant in many industries . . . but none more than in Electronics. And, KINNEY High Vacuum Pumps, Complete Systems and Component Parts, play a particularly important role in these advances . . . important to you from the standpoint of: *Product Improvement, Increased Production and Sound Economy.*

The KINNEY Mechanical Booster Pump delivers ultimate pressures to less than 0.1 micron.

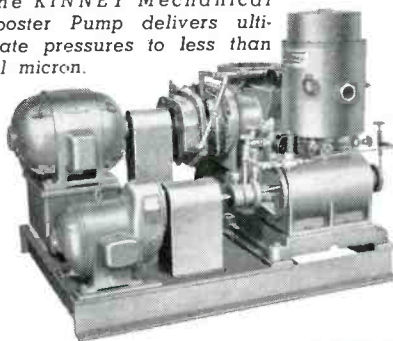

Today, the KINNEY line represents the broadest selection of High Vacuum Pumps in the world. In performance, KINNEY Pumps deliver ultimate pressures to 0.10 micron. Thus, with KINNEY you can provide a Prescription Answer to Your Vacuum Problem.

What is true of Pumps is also true of new developments in complete High Vacuum Systems for research, pilot plant or full production.

WRITE:

get the facts on
**KINNEY High
Vacuum Pumps,
Complete Sys-
tems, Valves,
Gauges, etc.**

KINNEY MFG. DIVISION THE NEW YORK AIR BRAKE COMPANY

3565 WASHINGTON STREET • BOSTON 30 • MASS.

Kindly send me full information on new developments in

- KINNEY High Vacuum Pumps
- KINNEY High Vacuum Components
- KINNEY High Vacuum Systems for Electronics

Name _____

Company _____

Address _____

City _____ Zone _____ State _____

Four Bulletins on FANSTEEL TANTALUM CAPACITORS

Fansteel TANTALUM CAPACITORS
Bulletin 6.100-1
Supersedes Bulletin 6.100

WRITE FOR BULLETINS INDICATED

- Bulletin 6.100 "PP" Series—For General Use
- Bulletin 6.111 "HP" Series—High Temperature
- Bulletin 6.112 "STA" Series—Solid Tantalum
- Bulletin 6.113 "VP" Series—Vibration Resistant

FANSTEEL METALLURGICAL CORPORATION
NORTH CHICAGO, ILLINOIS, U.S.A.
RECTIFIER-CAPACITOR DIVISION



CS77A

FANSTEEL METALLURGICAL CORPORATION
North Chicago, Illinois, U. S. A.

high-gain d-c amplifiers, error indicating systems, multichannel data systems and the like.

Current models include single or multiple pole, stacked, concentric, opposed, raised contact, segmented or printed circuit design. A brochure may be had upon request. Circle 455 on Reader Service Card.



FLAT-FACED CRT

small-sized, all glass

RAYTHEON MFG. Co., 55 Chapel St., Newton 58, Mass., has announced an improved version of the 3UP1, a small-sized, all-glass 1 $\frac{1}{8}$ in. by 2 $\frac{1}{8}$ in. rectangular flat-faced crt. A new two-piece bulb design permits the flat faceplate to have a uniform thickness which greatly improves this feature over the previously available tubes. Other features of the tube are a phosphor screen size of 1 $\frac{1}{8}$ in. by 1 $\frac{1}{8}$ in., electrostatic focus and deflection, 1 $\frac{1}{8}$ in. neck diameter, 7 $\frac{1}{2}$ in. tube length with a standard 12-pin base. For use as a display indicator, the 3UP1 can be made available with various screen colors and persistences. Circle 456 on Reader Service Card.



MINIATURE CHOPPER

has no moving parts

KEARFOTT Co., INC., Little Falls, N. J., announces immediate avail-

ability of an all-electronic chopper containing no moving parts, which for all practical purposes assures a minimum operating life of 5,000 hours.

Although used primarily as a d-c voltage into a-c voltage converter sensitive to the phase of the reference voltage it can be used to convert a-c into a d-c voltage.

Primary features include the following: zero phase shift, 180 deg dwell time; frequency range from 60 cps to 20 kc; unlimited life when properly applied; meets or exceeds the requirements of MIL-E-5272A; and standard 7-pin miniature socket plug-in base.

Characteristics of the No. 333058 chopper (used as modulator) are: reference power—6.3 v at 2 ma; load resistance—1,000 ohms to 1 megohm; load current—5 ma maximum; and d-c signal input—1 mv to 5 v. Circle 457 on Reader Service Card.



MEGOHMMETER speeds production testing

KEITHLEY INSTRUMENTS, INC., 12415 Euclid Ave., Cleveland 6, Ohio. Many production and laboratory tests can be made faster and more accurately with the new model 510 megohmmeter. It measures six decades of resistance on a single six-inch mirror scale and has 5 to 10 times faster response than conventional ohmmeters.

Typical uses are: rapid checking of insulation resistance of motor windings, capacitors, transformers, cables and many appliances; and measurements of surface and volume resistivity in insulating compounds. With its 5, 50 and

New Bulletin

FANSTEEL SILICON RECTIFIERS

- Write today
for your
FREE Copy

FANSTEEL METALLURGICAL CORPORATION
North Chicago, Illinois, U. S. A.



€ 378%

DIFFERENTIAL DATA AMPLIFIER

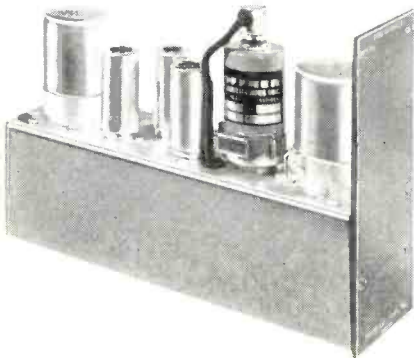

For amplification of thermocouple, strain gage, and similar low level signals the Type 190 Data Amplifier provides a combination of features available in no other amplifier:

- ☆ Infinite rejection of common-mode d-c signals
- ☆ One microvolt input resolution
- ☆ Gain stability of 0.01%
- ☆ Rapid step input response
- ☆ Linearity of 0.05%

Ask for bulletin No. 572
giving full technical information

OFFNER DYNOGRAPH Direct-Writing Oscillograph

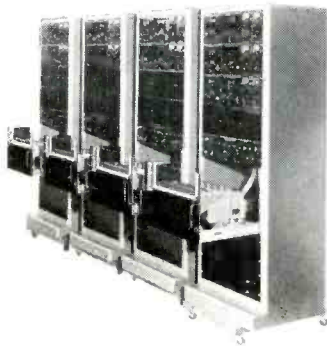

Zero-drift d-c recorder with micro-volt sensitivity. One amplifier type covers all requirements. Models for one to 19 channels. Rectilinear or curvilinear recording.

Ask for bulletin No. L-861



**OFFNER
ELECTRONICS**
5324 N. Kedzie Avenue
Chicago 25, U.S.A.

Circle 247 Readers Service Card

500 v test potentials, the instrument provides a selection of safe voltages for measuring all test samples and for checking voltage coefficients.

Features of the model 510 include elimination of range-switching, a linear scale with no compression at the high end, negligible drift, simple operation controls, and a guarded, completely shielded input.

Details are available in *Engineering Notes*, Vol. 5 No. 9. Circle 458 on Reader Service Card.

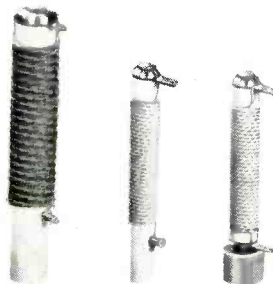

RL-100 RL-101 RL-102

R-F CHOKES for transmitting

RAYPAR, INC., 7800 W. Addison St., Chicago 34, Ill., has introduced a new line of frequency-rated r-f choke coils. Six part numbers, RL-100, RL-101, RL-102, RL-110, RL-111, and RL-112, offer medium and high power units in three mounting types for use on frequencies between 3.5 and 31 mc, and 12 and 55 mc.

These application-designed chokes insure predictable performance on prescribed frequencies. Catalog bulletin RL 557-10 gives complete description. Circle 459 on Reader Service Card.

FREQUENCY INDICATOR and counter

ELECTRO-PULSE, INC., 11861 Teale St., Culver City, Calif. A new solution to industrial counting and recurrence rate measurement problems, the model 7340C frequency indicator and counter is a low-cost reliable instrument easily operated by nontechnical personnel.

Advanced physical design fea-

HIGH Sensitivity RELAYS

for Military Equipment
and
Commercial Applications

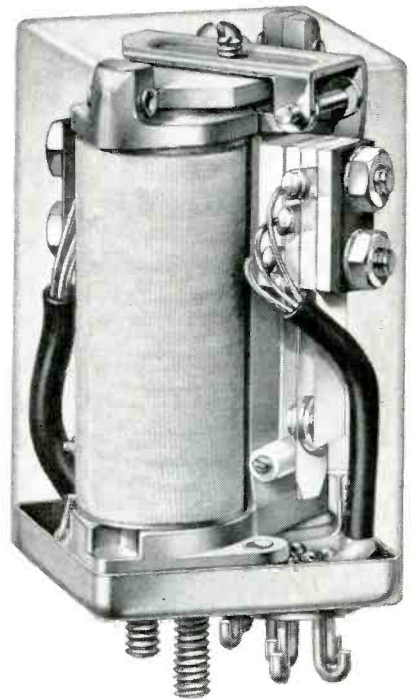

- Meet MIL R-5757C and MIL R-25018 specifications.
- Sensitivity down to 6 mw.
- Coil Resistances to 20,000 Ohms.
- Switching Capacities up to 5a., 28 v., d.c.
- Standard contact arrangements to DPDT.
- Same long life and reliability in relays for commercial applications.

All relays may be purchased in a wide variety of terminals and mounting means to suit most applications.

Early delivery of relays built to standard specifications.

WRITE FOR RELAY DATA BULLETIN



BASO INC.

formerly

MILWAUKEE GAS SPECIALTY CO.

Dept. RE-1, Milwaukee 1, Wisconsin

Circle 248 Readers Service Card

November 1, 1957 — ELECTRONICS



tures printed wiring and modular construction, with snap-off top and bottom plates allowing full access for ease of maintenance.

The input signal (photocell, tachometer generator, or flowmeter) is counted during a known time base (0.1 sec, 1 sec, and 10 sec) and displayed.

A self-test switch position, for check of time bases and counters, is provided and the instrument may be used with an external time base. **Circle 460 on Reader Service Card.**



OCTAL SOCKET

for klystron tubes

GLOBE ELECTRICAL MFG. CO., 1729 West 134th St., Gardena, Calif. Assembly time can be reduced and rework eliminated by the use of a new moulded chassis mounted octal socket for the JAN-CRP-2K45 thermally tuned klystron tube. Self-aligning gold-plated contacts are flexibly mounted in slightly over-size orifices of a glass-filled diallyl phthalate socket body. The new socket provides accurate alignment and probe penetration in the waveguide mount which avoids any possibility of mismatch.

Design of the new klystron tube socket also eliminates both the need for insulated bushings and

This outer jacket is TEFLON®. . . Quick as a Pixie's wink we can change it to Nylon, Vinyl, Kel-F; Silicone or Teflon impregnated fiberglass; or lacquered Nylon Braid!

Feast your eyes on this outer conductor! It's precision-engineered and fashioned of silver plated copper with 90% minimum coverage . . . Tops in reliability!

Here's quality that stands up under close inspection! Extruded Teflon Dielectric.

This is where flexibility begins! Stranded conductors of 25 or 30 AWG . . . Silver Plated Copperweld.

MINIATURE COAX C A B L E by Tensolite

Here is a "Pixie Eye View" of Tensolite's new miniature Coaxial Cable . . . and here are the answers to some of the questions you will ask:

TEMPERATURE RANGE: From -90° to $+250^{\circ}\text{C}$. . . depending on jacket used. Teflon jackets approved for entire temperature range listed.

IMPEDANCE VALUES: 50, 70, 75, 93 and 95 OHMS available from TENSOLITE as standard constructions.

TO MILITARY SPECIFICATIONS: MIL-C-8721 (with KEL-F jacket); RG-178, RG-179 and RG-180. MIL-C-17B (with TEFLON jacket); RG-187/U, RG-188/U, RG-195/U and RG-196/U.

COLOR CODED JACKETS: In standard colors and striped combinations.

AND FOR YOUR CUSTOM REQUIREMENTS: TENSOLITE Factory and Field Engineers are ready to assist you in the Design, Development and Production of any miniature Coaxial Cables for specific or unusual applications. Simply write or call TENSOLITE for complete descriptive literature and samples.

© DUPONT

Tensolite INSULATED WIRE COMPANY, INC.
198 MAIN STREET, TARRYTOWN, N. Y.
PACIFIC DIV.: 1516 N. GARDNER ST., LOS ANGELES, CALIF.





**HERE'S THE RELAY
THEY'RE TALKING ABOUT**

The NEOMITE

Designers are excited about the unique advantages of Elgin's new *NEOMITE* Relay. It's the world's smallest, weighing just .09 ounces, and requires only 100 milliwatts of power to open and close electrical circuits. *There's nothing like it for size or performance . . . and now they're available from leading distributors.*



SPECIFICATIONS

Relay Type	NMIC 50	NMIC 200	NMIC 500	NMIC 1K	NMIC 2K
D. C. Coil Resistance ($\pm 10\%$ @ 20°C)	50 Ohms	200 Ohms	500 Ohms	1000 Ohms	2000 Ohms
Coil Voltage	3-5 V.D.C.	6-10 V.D.C.	9-15 V.D.C.	12-21 V.D.C.	18-30 V.D.C.
Pickup	44 MA Max.	22 MA Max.	14 MA Max.	10 MA Max.	7 MA Max.

Duty: Continuous
Dropout: 30 to 60% of pickup
Contact Rating: .25 AMP at 28 V.D.C. resistive load
Operation Time: 4 milliseconds max. @ rated voltage
Dielectric Strength: Sea level: 500 V RMS. High altitude: 500 V RMS

Shock: Shock test: 50 G. without damage
Vibration: 10 G to 500 cps
Contact Arrangement: SPDT Form C
Ambient Temperature Range: -55°C to $+85^{\circ}\text{C}$
Life: 1,000,000 operations at rated load
Contact Resistance: .05 Ohms

YOU'LL FIND WHAT YOU WANT IN ELGIN'S ADVANCE RELAY LINE



Midget Antenna
AM Series



Latching
LE & LH Series



Coaxial
CB Series



Power Control
PC Series



Power Transfer
PV Series

. . . it's the most complete line of relays to meet almost every need. And they're available from stock at leading distributors all over the country. Write today for catalog information.



ELECTRONICS DIVISION
 ELGIN NATIONAL WATCH COMPANY
 Elgin, Illinois

any contact shorting to the waveguide tube mount. Contact tabs are easily accessible for fast accurate circuit assembly. Circle 461 on Reader Service Card.



D-C POWER SUPPLY voltage regulated

OPAD ELECTRIC CO., 69 Murray St., New York 7, N. Y. Model 7M25 is a tubeless laboratory type regulated d-c power supply with a continuous duty rating of 0-150 v d-c at 2 amperes. Voltage regulation is held to ± 1 percent and ripple is less than 0.03 percent of the average d-c at maximum output.

Extremely compact, the unit occupies only $8\frac{1}{2}$ in. of panel height. Depth behind the panel is 9 in.

Controls include a power switch, pilot light, indicating type line and load fuses, a $4\frac{1}{2}$ in. 2-percent accurate d-c voltmeter and ammeter and a pair of 5-way insulated binding posts. An additional pair of output terminals are provided at the rear of the chassis.

The equipment is also available in a cabinet for bench use. The bench unit is designated Model TM25B. Circle 462 on Reader Service Card.

TWIN TRIODES for f-m tuner circuits

RADIO CORP. OF AMERICA, Harrison, N. J. The 6DT8 and 12DT8 are high-mu twin triodes of the 9-pin miniature type. They are intended for use as combined oscillator-mixer and r-f amplifier tubes in cathode-drive or grid-drive circuits of f-m tuners. The tubes which differ only in their heater voltage and current, may also be

**alumina
ceramics**
for electronic applications

Now you can apply the unique properties of alumina ceramics to special electronic projects:

- Low dielectric losses at all microwave frequencies.
- Extremely high mechanical strength in conjunction with thermal stability and chemical inertness.
- Can be metallized and hermetically sealed to various metals by high temperature brazing.

Frenchtown alumina ceramics are produced in a variety of sizes and geometries, either in prototype or production quantities. Dense shapes of over 200 cubic inches have been manufactured.

To engineers and scientists who wish to learn more about the capabilities and limitations of alumina ceramics, Frenchtown welcomes the opportunity to assist in the selection and proper utilization of these amazing materials. This assistance is directed toward obtaining optimum performance, simplifying complexity, reducing cost and expediting delivery.

Technical literature will be sent upon request.

frenchtown
PORCELAIN COMPANY
FRENCHTOWN, NEW JERSEY

Circle 251 Readers Service Card
ELECTRONICS — November 1, 1957

NEW PRODUCTS

(continued)



used in a wide variety of applications in tv receivers.

The two units of each type are effectively isolated from each other by an internal shield having a separate base-pin terminal. This shielding arrangement enables the designer to achieve substantial reduction in antenna radiation and to obtain stable performance in h-f applications. In addition, the two cathodes in each type have separate base-pin terminals to provide the equipment designer with greater flexibility of circuit connectors. Circle 463 on Reader Service Card.

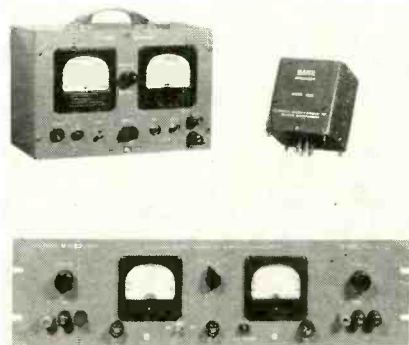

L-V POWER SUPPLIES
packaged for various uses

ELECTRONIC ASSEMBLY Co., INC., 5 Prescott St., Boston 19, Mass. Another source of transistorized power supplies is now available with the entry of the Minisource. These power supplies are semi-variable with nominal voltages ranging from 6 to 50 v and full load current ratings from 50 to 500 ma.

Designed for either 60 or 400

DIGITIZERS REPLACE COMPLEX ELECTRONIC EQUIPMENT

DIGITIZER

[Analog to Digital]

The Coleman DIGITIZER provides a simple, economical, and reliable method of recording, in digital form, the analogs of temperature, pressure, voltage, strain, distance, etc. This record may be produced automatically by printers, punched cards, electric input typewriters, and perforated-tape machines.

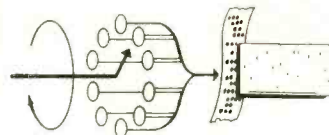

Shaft rotation input. Unambiguous contact setting. Digital contact output.



DECIMAL DIGITIZER



BINARY DIGITIZER



BINARY-CODED DECIMAL DIGITIZER

[Digital to Analog]

Converts... DIGITIZERS can also be used in automation systems as a positioning device to convert digital inputs to predetermined shaft position.

Your name.....

Company.....

Address.....

Write for Free Data File.
Mention your application.

Coleman

Engineering Company, Inc.
6040 West Jefferson Boulevard
Los Angeles 16, California

Circle 252 Readers Service Card

DIGITIZERS REPLACE COMPLEX ELECTRONIC EQUIPMENT

SPECIFY *HOYT* METERS

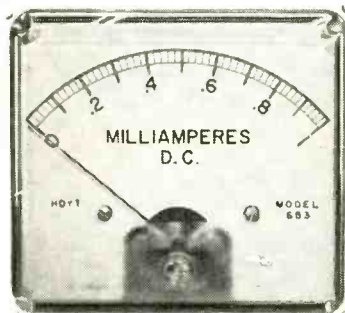

No. 653 Illustrated

for **EVERY** **APPLICATION**

NEW! 2 1/2, 3 1/2, 4, 4 1/2 inch, anti-static treated, AC or DC meters with clear polystyrene cases for modern installations. Feature standard or matched colors on lower frosted panel for appearance and functional identification.

Be sure of the highest accuracy, dependability, and readability PLUS economy with HOYT precision AC and DC instruments—the complete line of Panel Meters. Moving coil, rectifier, and repulsion types available in a wide variety of sizes, ranges, cases, and colors. Also, custom-designed to meet your most rigid specifications for a quality instrument.

Write for NEW, fully illustrated literature containing descriptions, engineering data, and prices.



Write to Export Manager regarding world-wide availability for original equipment and replacement use.



ELECTRICAL INSTRUMENTS

Sales Div.: BURTON-ROGERS COMPANY

42 Carleton Street, Cambridge 42, Mass., U.S.A.

Circle 253 Readers Service Card

Wire Forming

Metal Stamping

Deep-Drawing

Write for Catalog or to have our representative call.

EASTERN TOOL & MFG. CO.

1 Montgomery St., Belleville 9, N. J.
Phones: New York—REctor 2-7875
Belleville—PLYmouth 9-7100

cycle operation, ripple and regulation factors are better than 0.5 percent; with temperature range of operation from -30 to +65 C. Units have passed shock and vibration tests.

The photograph shows how the units have been packaged for various design applications: for laboratory use, for incorporation with various types of instrumentation, and in special packaging for a variety of industry's needs. Circle 464 on Reader Service Card.

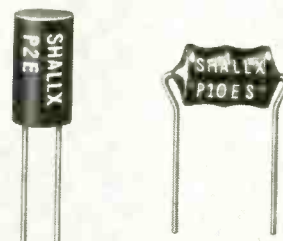

WIREWOUND RESISTORS for printed circuits

SHALLCROSS MFG. Co., Collingdale, Pa. Two miniature precision wirewound resistors designed especially to meet the size and mounting requirements of printed circuits are available. Both are fixed noninductively wirewound types sealed in epoxy resin, and suitable for operation in ambients up to 125C. The distance between leads is closely controlled for manual or automatic insertion in printed circuit boards.

The P-2 resistor is only 3/4 in. long and 1/8 in. in diameter. Termination is by means of two No. 20 axial leads at one end of the resistor. Resistances up to 200,000 ohms may be supplied to tolerance as close as 0.1 percent. The power rating for 1 percent tolerance has been tentatively established at 0.3 w for a 125 C ambient.

For higher resistance values the P10S resistor, 1 1/2 in. long and 1/4 in. diameter, is recommended. It has No. 20 axial wire leads at each end. The resistor will lie flat on a printed circuit board for vibration and shock resistance. Resist-

AN INVITATION TO JOIN ORO

Pioneer In Operations Research

Operations Research is a young science, earning recognition rapidly as a significant aid to decision-making. It employs the services of mathematicians, physicists, economists, engineers, political scientists, psychologists, and others working on teams to synthesize all phases of a problem.

At ORO, a civilian and non-governmental organization, you will become one of a team assigned to vital military problems in the area of tactics, strategy, logistics, weapons systems analysis and communications.

No other Operations Research organization has the broad experience of ORO. Founded in 1948 by Dr. Ellis A. Johnson, pioneer of U. S. Opsearch, ORO's research findings have influenced decision-making on the highest military levels.

Our computer laboratory is equipped with the 1103-A Univac, the "Cadillac" of computers. Encompassing 1200 sq. ft., it is leased at a cost of \$40,000 per month. ORO's professional atmosphere encourages those with initiative and imagination to broaden their scientific capabilities. For example, staff members are taught to "program" their own material for the Univac computer so that they can use its services at any time they so desire.

ORO starting salaries are competitive with those of industry and other private research organizations. Promotions are based solely on merit. The "fringe" benefits offered are ahead of those given by many companies.

The cultural and historical features which attract visitors to Washington, D. C. are but a short drive from the pleasant Chevy Chase suburb in which ORO is located. Attractive homes and apartments are within walking distance and readily available in all price ranges. Schools are excellent.

For further information write:
Professional Appointments

OPERATIONS RESEARCH OFFICE

The Johns Hopkins University
7100 CONNECTICUT AVENUE
CHEVY CHASE, MARYLAND

NEW PRODUCTS

(continued)

ances up to 1 megohm may be supplied to tolerances as close as 0.1 percent. Power rating for 1 percent tolerance is 0.5 w for a 125 C ambient. Circle 465 on Reader Service Card.

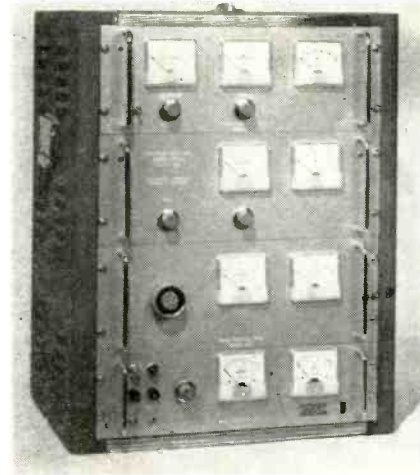

TWT POWER SUPPLY

general purpose unit

WAVE PARTICLE CORP., P. O. Box 252 Menlo Park, Calif. Model 500 is a versatile general purpose traveling wave tube power supply which will operate most low-level and intermediate-level traveling wave tubes. Regulation is within 0.1 percent on the anode, helix and bias, within 1 percent on the solenoid and collector, within 1 percent line on the heater, and within 10 percent on the input. Price is \$2,200. Circle 466 on Reader Service Card.

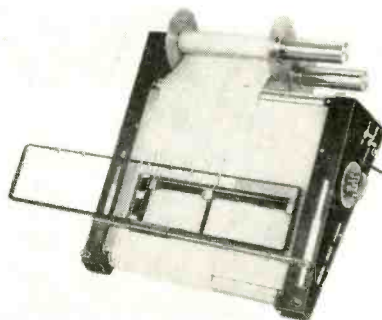

OSCILLOGRAM READER

priced at only \$1,740

THE GERBER SCIENTIFIC INSTRUMENT Co., 162 State St., Hartford 3, Conn. Model R-1 data reader is a new, inexpensive oscillogram

CRITICAL POT SPECS* are met at CIC

INFINITE
RESOLUTION

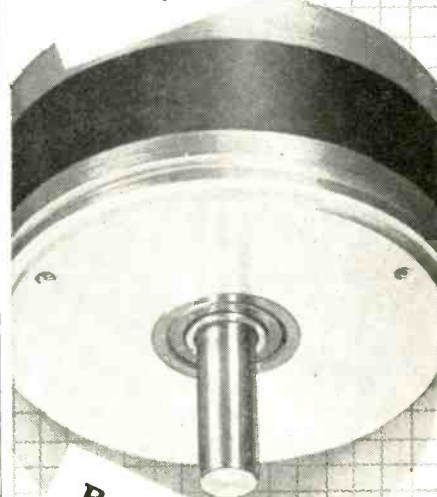

Precision
CARBON FILM POTS



Equipment designers who demand more than "shelf item" specifications, rely on CIC for dependable delivery of ultra-precise potentiometers.

The result of CIC research, carbon film potentiometers are setting new standards of accuracy, life at higher speeds and performance reliability.

CIC has assisted many firms in a wide variety of industrial instrumentation, military fire control and flight guidance equipment.

Why not discuss your specific requirements with us?

*New carbon film techniques assure virtually infinite resolution; linearity to .01%, sine-cosine to .025%; compact ganging; precision ball bearing servo construction.

"For Precision Performance...specify CIC"

Detailed Technical Data
Sheets available on request.



**COMPUTER
INSTRUMENTS
CORPORATION**

92 Madison Ave. • Hempstead, Long Island, N. Y.

Circle 255 Readers Service Card



Specialists IN STAMPING AND DRAWING

- KOVAR • RODAR
- THERLO • FERNICO
- Other IRON-NICKEL-COBALT Alloys

COMPLETE FACILITIES FOR PRECISION PRODUCTION OF ELECTRONIC COMPONENTS

Our facilities are geared to meet your production and engineering needs for components of any description. Unusually Complete Tool Room • Press Shop • Hydrogen Annealing, Machining and Polishing Operations • Glass-to-Metal Hermetic Sealing. Production of completed parts ready for assembly in your own plant.

A complete service in our plant means prompt service to your plant.

CUT TOOLING COSTS!

Over 3,000 high precision tools and dies available to reduce your initial tooling time and costs.

Call on us for free consultation and quotations.

ZELL PRODUCTS CORP.
279 Main Street, Norwalk, Conn.

Circle 256 Readers Service Card

TELREX LABORATORIES

Designers and Manufacturers of

COMMERCIAL SERVICE "BEAMED-POWER" ARRAYS

Calibrated
for the commercial
13 to 14
mc. band.
Other
frequencies
available.

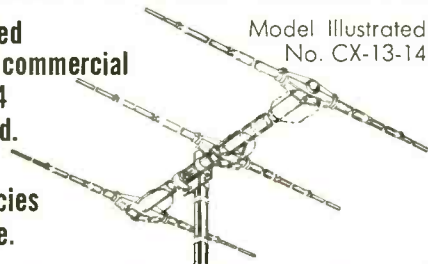

Model Illustrated
No. CX-13-14

Precision Tuned, Matched and Calibrated for easy assembly and repetition of our Specifications at your site, providing optimum gain per element and hi-signal-to-noise, hi-signal-to-interference "Balanced Pattern."

Electrical Specifications: Gain 8 db, F/B ratio 28 db, V/S/W/R 1.2/1 or better! Impedance, 52 ohm thru coaxial halfwave "Balun" (supplied). Power capacity 5 KW — Higher power models available at extra cost.

Mechanical Specifications: Wt. 60 lbs., 3" OD x 26 ft. boom, taper swaged elements, tapering from 1 3/8" OD to 1/2" OD, incorporating stainless steel hardware, "Borg-Warner" Cycolac moldings, 1/4-20 S.S. junction terminals and heavily cadmium plated mounting plate. Wind surface area: 7 sq. ft. Wind load at 100 mph: 210 lbs.

Price \$338.00 f.o.b. Asbury Park, New Jersey
Available three (3) days after receipt of order.
Descriptive literature on request.

Telrex is equipped to design and supply to our specifications or yours, Broad-band or single frequency, fixed or rotary arrays for communications, FM, TV, scatter-propagation, etc.

Consultants and suppliers to communication firms, universities, propagation laboratories and the Armed Forces.



telrex LABS.
COMMUNICATION & TV
ANTENNAS SINCE 1921

**ASBURY PARK 25
NEW JERSEY, U.S.A.**
Tel. PRespect 5-7252

Circle 257 Readers Service Card

reader. It is capable of handling any number of linear or nonlinear channels, correcting for linear or nonlinear scale factors, as well as automatically correcting for the zero line location of each channel. Tracking, record damage and record tension problems have been virtually eliminated.

Features include film widths of 0-16 in.; 6-in. maximum roll diameter; expendable strawboard rolls which can be loaded right in the darkroom; designed for both reading and scanning; pushbutton operation forward and reverse from panel or with foot switch; special variable scale for linearizing all channels; markers provided for quick individual channel reference line location; vertical variable scale to count cycles, read frequencies, or space stations directly; X, Y type reading system, adjustable speed drive with variable transformer control, brake motor to stop instantly; cantilevered rolls for quick, easy loading. A bulletin is available. Circle 467 on Reader Service Card.



SELENIUM RECTIFIER requires no filament supply

BRADLEY LABORATORIES, INC., New Haven, Conn., is manufacturing a new selenium rectifier, designed to replace a 6AL5 vacuum tube in tv circuits where the peak inverse voltage does not exceed 40 v.

Primary advantages of the new unit (model SE51K4D883) over the tube are that it does not require any filament supply, provides practically unlimited service life and will withstand current surges as high as 80 ma.

Specifications for the unit are: maximum applied voltage of 26 v rms; maximum d-c output voltage of 20 v; peak inverse voltage

of 40 v. Rectifier plates are encapsulated in a molded phenolic housing whose low coefficient of expansion resists effects of changing temperatures. Circle 468 on Reader Service Card.

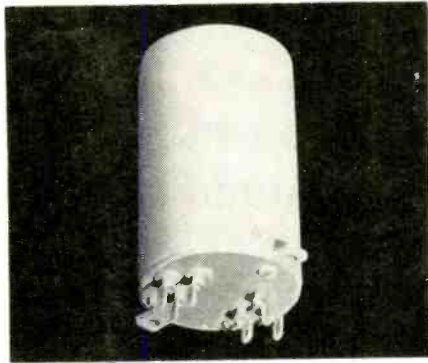

COMPONENTS OVEN
for capacitors and the like

BULOVA WATCH Co., Electronics Division, Woodside 77, N. Y., introduces their new AM-200 oven. The new oven is specifically designed for components such as capacitors, resistors and transistors.

The AM-200 oven cavity measures 1 in. in diameter by 2 in. in length. Temperature regulation is ± 3 C over an ambient range of -55 C to $+100$ C. It is available with either plug-in or stud mountings. Circle 469 on Reader Service Card.

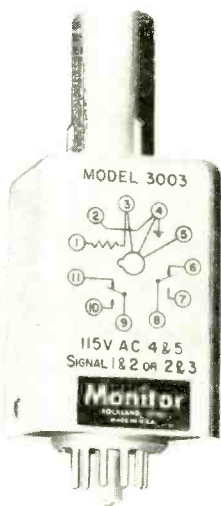

ELECTRONIC RELAY
multipurpose type

MONITOR CONTROLLER, 99 Grove St., Rockland, Mass. Model 3003 relay will operate with as much as $\frac{1}{2}$

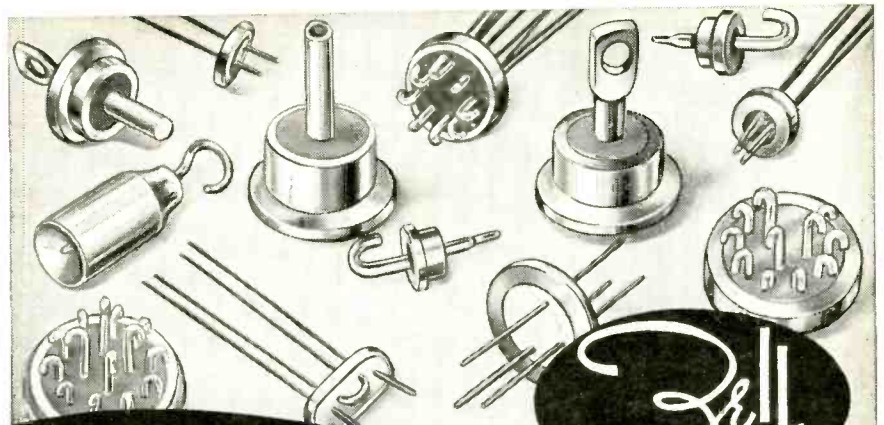

Compression and Kovar Type
HERMETIC SEALS

"The Seal of Excellence"

Meeting the ever-increasing standards of perfection established by the electronics industry is a challenge admirably met by Zell's highly skilled engineers. They are able to exercise unusually rigid quality controls because all production operations are carried out in Zell's own completely equipped, ultra modern plant.

SPECIALISTS IN STAMPING AND DRAWING KOVAR — RODAR — THERLO — FERNICO AND OTHER ALLOYS
Write us for FREE Technical Consultation and Information.

ZELL Hermetic Seals Enjoy
These Desirable Characteristics:

- ★ A stable finish that protects seals against corrosive atmospheres. ZELL'S GOLD PLATE WITHSTANDS THE MOST STRINGENT TRANSISTOR ETCH TESTS DEvised.
- ★ High resistance to mechanical and thermal shock.
- ★ Excellent electrical properties.
- ★ Tight dimensional tolerances.
- ★ Easy weldability and solderability.

ALL FACILITIES UNDER ONE ROOF

- Complete tool room facilities.
 - 65 Power Presses (to 50 tons).
 - Double stage annealing-fusing furnaces.
 - Advanced plating facilities for Nickel, Gold, Tin, Cadmium, Copper, Silver, etc.
 - Complete glass facilities.
 - Mass Spectrometer leak testing.
- ZELL engineers control every process every step of the way, assuring uniform quality and performance.

REPRESENTATIVES: Your Inquiries invited!

ZELL PRODUCTS CORP.
279 Main Street, Norwalk, Conn.

The completeness of our facilities assures the completeness of your satisfaction!

Circle 258 Readers Service Card

Make springs yourself . . . fast, exact!
WITHOUT USE OF ARBORS

For a replacement or experimental spring, any shape, diameter or pitch from flat or round wire sizes .005" to .125", you can produce it in a matter of seconds with Perkins Precision Spring Coiler. You eliminate arbors, yet turn out precision springs — torsion, compression, extension, tapered, or special springs, coiled either



Starret adjustable jaw cut nippers (left) and Gardener Hook-Kon spring looping tool (center) — handy, precision, time-saving accessories for spring coiling. Perkins Spring Coiler available as bench model or power model shown here, (right) for tool shop or continuous runs.

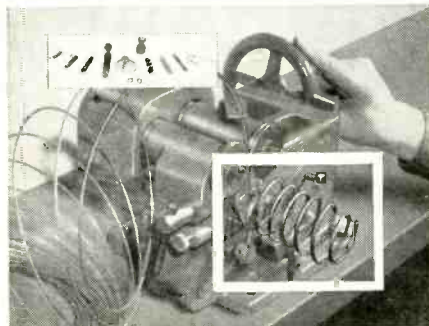

left or right hand, in any desired length, any diameter from 3/32" to 12" and larger, with or without initial tension, and with open or closed ends. Eliminate expensive special orders and costly production delays! Make your own springs to exact specifications as replacements or experimental work. Make them fast, right in your own shop!



Perkins Machine and Gear Co.
Special Machinery Division, Dept. C3
W. Springfield, Mass.
Please send information and prices on Perkins Spring Coiler.
Hand Model Power Model

Name.....Title.....
Company.....
Address.....
City.....State.....

the specs are the proof . . .
the BEST BUYS are **EICO**[®]
for COLOR & Monochrome TV servicing



NEW COLOR
and Monochrome
DC to 5 MC LAB & TV
5" OSCILLOSCOPE

=460
Factory-wired
and tested \$129⁵⁰
Also available as kit \$79⁹⁵

• Features DC Amplifiers!

Flat from DC-4.5 mc, usable to 10 mc. **VERT. AMPL.:** sens. 25 rms mv/in.; input Z 3 megs; direct-coupled & push-pull thruout; K-follower coupling bet. stages; 4-step frequency-compensated attenuator up to 1000:1. **SWEEP:** perfectly linear 10 cps-100 kc (ext. cap. for range to 1 cps); pre-set TV V & H positions auto. sync. ampl. & lim. **PLUS:** direct or cap. coupling; bal. or unbal. inputs; edge-lit engraved lucite graph screen; dimmer; filter; bezel fits std. photo equlpt. High intensity trace CRT. 0.06 usec rise time. Push-pull hor. ampl. flat to 400 kc, sens. 0.6 rms mv/in. Built-in volt. calib. Z-axis mod. Sawtooth & 60 cps outputs. Astig. control. Re-trace blanking. Phasing control.

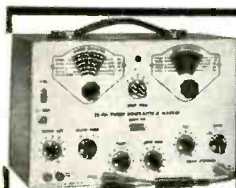

NEW TV-FM
SWEEP GENERATOR
& **MARKER**

=368
Factory-wired \$119⁹⁵
and tested
Also available \$69⁹⁵
as kit

Entirely electronic sweep circuit (no mechanical devices) with accurately-biased inductor for excellent linearity. Extremely flat RF output; new AGC circuit automatically adjusts osc. for max. output on each band with min. ampl. variations. Exceptional tuning accuracy; edge-lit hairlines eliminate parallax. Swept Osc. Range 3-216 mc in 5 fund. bands. Variable Marker Range 2-75 mc in 3 fund. bands; 60-225 mc on harmonic band. 4.5 mc Xtal Marker Osc., xtal supplied. Ext. Marker provision. Sweep Width 0-3 mc lowest max. deviation to 0-30 mc highest max. dev. 2-way blanking. Narrow range phasing. Attenuators: Marker Size, RF Fine, RF Coarse (4-step decade). Cables: output, 'scope horiz., scope vertical.

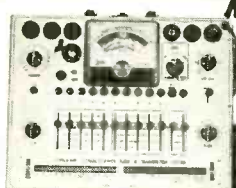

NEW DYNAMIC
CONDUCTANCE
Tube &
Transistor Tester

=666
Factory-wired \$109⁹⁵
and tested
Also available \$69⁹⁵
as kit

COMPLETE with steel cover and handle.

SPEED, ease, unexcelled accuracy & thoroughness. Tests all receiving tubes (and picture tubes with adapter). Composite indication of Gm, Gp & peak emission. Simultaneous sel of any 1 of 4 combinations of 3 plate voltages, 3 screen voltages, 3 ranges of continuously variable grid voltage (with 5% accurate pot). New series-string voltages: for 600, 450, 300 ma types. Sensitive 200 ua meter. 5 ranges meter sensitivity (1% shunts & 5% pot.) 10 SIX-position lever switches: free point connection of each tube pin. 10 push-buttons rapid insert of any tube element in leakage test circuit & speedy sel. of individual sections of multi-section tubes in merit tests. Direct-reading of inter-element leakage in ohms. New gear-driven rollchart. Checks n-p-n & p-n-p transistors: separate meter readings of collector leakage current & Beta using internal dc power supply. CRA Adapter \$4.50

See the 50 EICO models IN STOCK at your neighborhood distributor. Write for FREE Catalog E-11

Prices 5% higher on West Coast

EICO[®]

33-00 NORTHERN BLVD.,
LONG ISLAND CITY 1, N. Y.

Circle 260 Readers Service Card

megohm in series with the contacts. Relay action is initiated by an external contact connected to the input circuit and the current through the contacts is less than 10 millionths ampere with 500,000 ohm contact resistance.

Operating time is less than 0.05 sec and the relay will drop out in 0.05 sec or less. Power amplification is about 12 million to one, as input power is less than 0.00005 w and the output circuit can carry up to 600 w. A cold cathode-type tube is used and power consumption is less than 2 w. The relay operates from 115 v, 50-60 cps power input. Contacts are dpdt with 5-ampere resistive load.

A few of the many delicate operations the model 3003 relay can perform are level control for filling containers, using a probe; temperature or pressure control where a mercury column or Bourdon tube contacts the relay; precision measurement at the anvils of a micrometer; control of oil refining apparatus and electronic sorting equipment. The relay lists at about \$25. Circle 470 on Reader Service Card.



MULTIPLIER PHOTOTUBE

for scintillation counters

RADIO CORP. OF AMERICA, Harrison, N. J. The 7046 is a 14-stage head-on type of multiplier phototube intended for use in scintillation counters for the detection and measurement of nuclear radiation, and applications involving the measurement of low-level light sources.

The 7046 has fast response, high



GUDEBROD
BRAIDED
NYLON
LACING
TAPES ARE
EASY TO TIE:
WON'T SLIP—
EASY ON
THE HANDS:
WON'T CHAFE—
EASY TO SEE:
COLOR-CODED

Gudebrod flat braided lacing tapes hold harness securely—no bite-through or slip, yet are easy on the hands. Some resist high temperature, some are color-coded . . . and they come wax-coated or wax-free . . . rubber-coated . . . or with special coating. Gudebrod makes many tapes for many purposes, including defense work. Send us your lacing problems or your specifications . . . we can supply the answer to both.

GUDELACE • GUDE-NYLACE
GUDELACE H • TEFLACE

GUDEBROD BROS. SILK CO., INC.

ELECTRONICS DIVISION

225 W. 34th St., New York 1, N. Y.

EXECUTIVE OFFICES

12 South 12th St., Philadelphia 7, Pa.

Circle 261 Readers Service Card

November 1, 1957 — ELECTRONICS

current gain, high peak current capability and relative freedom from after-pulses. Its very small spread in electron transit time makes it particularly useful for fast coincidence scintillation counting.

Spectral response of the 7046 covers the range from about 2,500 to 6,500 angstroms, with maximum response occurring at approximately 4,200 angstroms. Design features are available on request. Circle 471 on Reader Service Card.

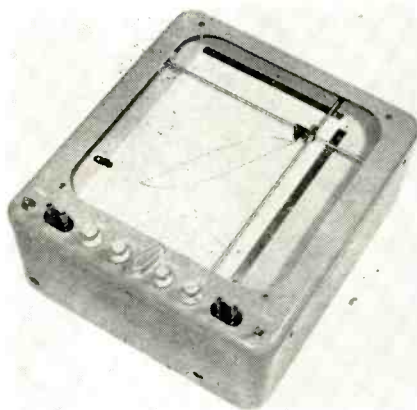

X-Y PLOTTER

with flat bed construction

MANDREL INDUSTRIAL INSTRUMENTS, division of Mandrel Industries, Inc., 5134 Glenmont Drive, Houston, Texas. The ER-90 X-Y plotter, with an input sensitivity as high as 1 mv per in., features a flat bed construction for full chart visibility and a slip-on pen plotting on standard 8½ in. by 11 in. paper. Reliable operation is insured by conventional chopper-stabilized amplifiers and standard 3-turn re-balance potentiometers in the null-seeking servo system plus a simplified cord drive system. The two axes are electrically independent.

Priced at \$520, this recorder has a limit of errors better than 0.75 percent, and a repeatability better than 0.5 percent. Circle 472 on Reader Service Card.

BEAM POWER AMPLIFIER

with stacked construction

SYLVANIA ELECTRIC PRODUCTS INC., 1740 Broadway, New York 19, N. Y., is producing an audio beam

Chip-proof PLASTIC LEGEND PLATES
engrave them yourself

Tough GRAVOFLEX blanks are laminated in sharp contrast colors. No need to keep large inventory—all sizes, varied colors available on short notice. Low-cost GRAVOFLEX legend plates stand up better, stand out better!

Use the portable ENGRAVOGRAPH to mark legend plates to your specifications, on the spot, when you need them—with unskilled labor, because it's tracer-guided. Big savings on short runs and "one-shot" jobs. Eliminates costly delays. 17,000 Engravographs in use.

Send for Booklet ZL-1 and sample plate

new hermes ENGRAVING MACHINE CORP.
13-19 UNIVERSITY PLACE, NEW YORK 3, N. Y.
Circle 262 Readers Service Card

Now you can
solder as easy as you write!
—with
HEXACON INSTRUMENT SOLDERING IRONS
—for fast soldering and long life on constant duty

Because of new efficient design, these tiny tips out-perform irons with larger tips and higher wattages. HEXACON offers a new standard in soldering iron efficiency for every conceivable need in the soldering of miniature assemblies.

Send for new circular No. 127 giving more details and comparative competitive performance data.

20Z. SUPER-PENCIL IRONS*
No. 25S 25w. 1/8" tip \$6.00
No. 26S 30w. 3/16" tip \$6.00

30Z. BANTAMWEIGHT HATCHET IRONS*
No. 25H 25w. 1/8" tip \$6.50
No. 26H 30w. 3/16" tip \$6.50

30Z. PIN-POINT IRONS*
No. P-25A 25w. 1/8" tip \$6.00
No. P-26 30w. 3/16" tip \$6.00

*Also available in higher wattages

INDUSTRY'S No. 1
HEXACON
SOLDERING IRON

HEXACON ELECTRIC COMPANY
130 West Clay Ave., Roselle Park, New Jersey

Type 2000 Laboratory Receiver

NEW PRODUCTS

(continued)

The NEMS-CLARKE Type 2000 Laboratory Receiver has been designed to fill the need for such a unit in development laboratories. It is an extremely useful instrument in antenna development and RF filter design.

The receiver operates in effect as a linear voltmeter having a 100 db range in 20 db steps. The receiver contains an output meter which has a logarithmic scale calibrated between 1 and 10. An IF gain control and a 20 db step attenuator in this receiver permits the microvoltmeter to be set at any desired full-scale range from 10 microvolts to 0.1 volt.

Audio frequency circuits in the receiver permit oral monitoring of both AM and FM transmission. The receiver is supplied in a cabinet and the panel is a light blue smooth finish.

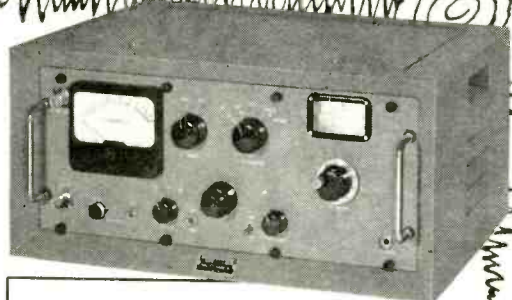

SPECIFICATIONS

Frequency range	54 to 240 megacycles
Sensitivity at input terminals as a voltmeter	1.0 microvolt
Maximum signal input direct to receiver	0.1 volt
Receiver input impedance	51 ohms
Intermediate frequency	21.4 megacycles
IF bandwidth	300 kilocycles
Output indicator	panel meter with logarithmic scale
Auxiliary outputs:	a: Audio for headphones
	b: DC output to operate a 1-ma chart recorder

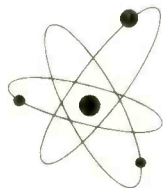

NEMS • CLARKE

A DIVISION OF VITRO CORPORATION OF AMERICA

919 JESUP-BLAIR DRIVE
SILVER SPRING, MARYLAND

For further information write department LR-1

Circle 264 Readers Service Card

power amplifier capable of maximum reliability in high ambient temperatures.

Designated type SN-2146B, the new tube, which makes use of the stacked ceramic construction, is capable of 4.5 w power output under class A conditions. Designed primarily for military equipment manufacturers the tube offers greater resistance to heat, shock, vibration, altitude and humidity than types hertofore available. Circle 473 on Reader Service Card.



SYNCHROVERTER CHOPPER for specialty circuits

THE BRISTOL Co., Waterbury 20, Conn., has announced a new Syncroverter chopper with a center-tapped coil. This new chopper should prove useful in a wide variety of special driving circuit applications, such as flip-flop, push-pull, or pulsed type. It offers the same contact ratings and high degree of reliability in dry circuit applications as does the company's standard Syncroverter chopper.

As a result of this coil construction, the unit can also be used as a polar relay, when a biasing voltage is applied, or as a true differential relay, which operates at a given predetermined differential, rather than on a specific amperage value for either coil. Coil requirements vary according to application; typical applications require approximately 90 peak ampere-turns.

Ambient temperature limits for the new chopper are -65 to 125 C. The output wave form of the chopper is unaffected during

PIX

WIRE FORMING SPECIALISTS

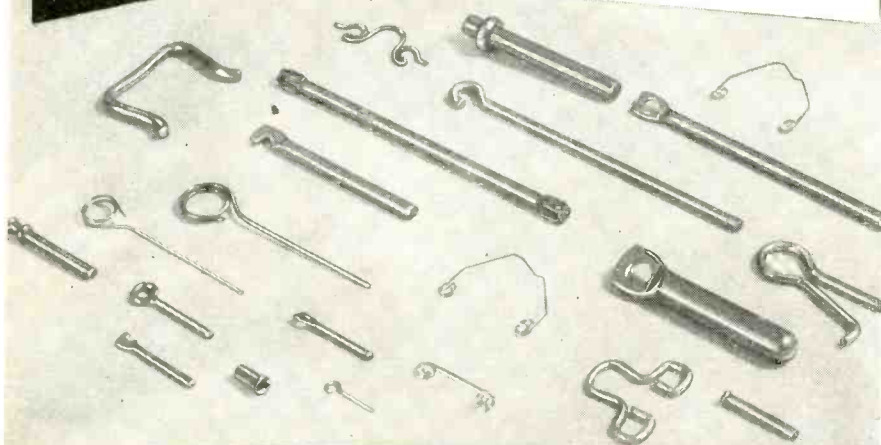

**PIX Manufacturing
Co., Inc.**

81-A Hudson St.
Newark 3, New Jersey

Precision Parts to meet your production and engineering needs. From .002" dia. to .187" dia. Modern Facilities, Hi-Production Equipment. Radio tube parts, stampings, drawings, relay components, transistor bases, terminal lugs, multi-slide stampings, beryllium copper contacts and printed circuit connectors.

Metal Crystal Holder Parts • Send sketch or print for quotation.

severe shock and vibration. It is available in either the newly-introduced external-coil, low-noise version, or in the standard model. **Circle 474 on Reader Service Card.**

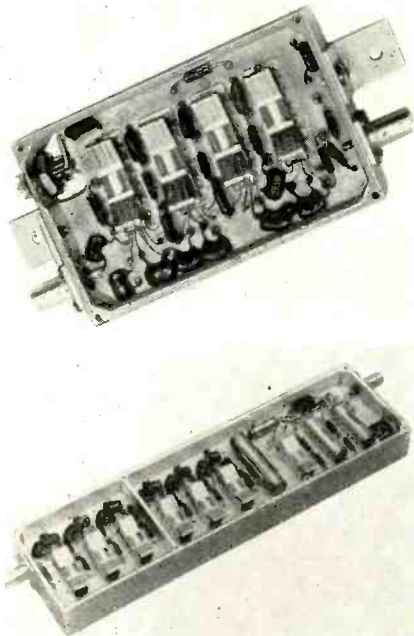

I-F AMPLIFIER

featuring fast recovery

LEL, INC., 380 Oak St., Copiague, L. I., N. Y., is in production on a new type of subminiature i-f preamplifier (model IF65) and main amplifier (model IF66) combination. Specifically designed for airborne use they are unique in their ability to detect 0.1 μ sec r-f pulses at a -116 dbm level for a peak video pulse output of 125 v. Following a -16 dbm signal the combination will detect a -116 dbm signal within 0.9 μ sec. **Circle 475 on Reader Service Card.**

COMPUTER ELEMENTS

transistorized, plug-ins

RANSOM RESEARCH, 323 W. Seventh St., San Pedro, Calif., has announced a line of computer elements for the design of industrial counting equipment, data processing equipment, logical control systems, digital systems and computer logic. They feature all transistor design, rapid design and construction, printed circuitry throughout,

TELEPHONE AND TELEGRAPH EQUIPMENT

Radio Engineering Products is currently producing a number of types of equipment, electrically and mechanically interchangeable with standard Bell System apparatus.

CARRIER-TELEPHONE EQUIPMENT

C5 Carrier-Telephone Terminal (J68756). A kit for adding a fourth toll-grade channel to existing C systems is available. • C1 Carrier-Telephone Repeater (J68757) • 121A C Carrier Line Filter • H Carrier Line Filter (X66217C).

CARRIER-TELEGRAPH EQUIPMENT

40C1 Carrier-Telegraph Channel Terminal (J70047C) • 140A1 Carrier Supply (J70036A1, etc.) • 40AC1 Carrier-Telegraph Terminal.

VOICE-FREQUENCY EQUIPMENT

V1 Telephone Repeater (J68368F) • Power Supply (J68638A1) • V1 Amplifiers (J68635E2 and J68635A2) • V3 Amplifier (J68649A) • V-F Ringers (J68602, etc.) • Four Wire Terminating Set (J68625G1) • 1C Volume Limiter (J68736C).

D-C TELEGRAPH EQUIPMENT

16B1 Telegraph Repeater (J70037B) • 10E1 Telegraph Repeater (J70021A) • 128B2 Teletypewriter Subscriber Set (J70027A).

TEST EQUIPMENT

2A Toll Test Unit (X63699A) • 12B, 13A, 30A (J64030A) and 32A (J64032A) Transmission Measuring Sets • 111A2 Relay Test Panel (J66118E) • 118C2 Telegraph Transmission Measuring Set (J70069K) • 163A2 Test Unit (J70045B) • 163C1 Test Unit (J70045D).

COMPONENTS AND ACCESSORIES

255A and 209FG Polar Relays • Repeating and Retard Coils, several types • 184, 185, 230A and 230B Jack Mountings.

RADIO ENGINEERING PRODUCTS
 1080 UNIVERSITY ST., MONTREAL 3, CANADA
 TELEPHONE UNIVERSITY 6-6887
 CABLES RADENPRO, MONTREAL

Circle 266 Readers Service Card

**12%
MORE
PRODUCTION**

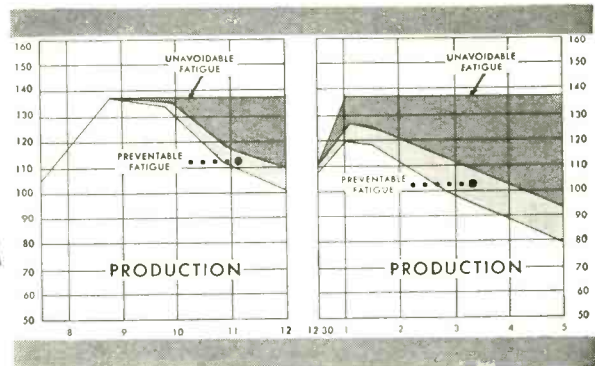

... worker fatigue reduced with *Royal*

INDUSTRIAL SEATING



Your workers are more alert, more productive when comfortably seated. Tests prove it! *Royal* industrial seating reduces fatigue, gives you high production all day (see charts above).

Posture is Personal. *Royal* industrial chairs let the worker sit the way he wants. Backs adjust 4 ways for individual comfort fit. *Royal* chairs adjust quickly, lock firmly. For any job, under any working conditions, there's a *Royal* chair that's just right—29 types and models.

ROYAL METAL MANUFACTURING COMPANY
 175 N. Michigan Avenue, Chicago 1, Ill., Dept. 30-L
 (In Canada: *Royal* Metal Manufacturing Co. Limited, Galt, Ont.) Please send Catalog 7001 on *Royal* Industrial Seating.

Individual _____
 Company _____
 Street _____
 City, Zone, State _____

PHAZOR NULL METER

A PHASE SENSITIVE NULL METER WHEREIN NOISE AND HARMONIC VOLTAGES ARE EFFECTIVELY ELIMINATED



MODEL 100A

PRICE
\$25900
F.O.B.
NEW YORK

- Allows separate balance of in-phase or quadrature in null circuits.
- Eliminates the necessity for filters.
- High sensitivity.
- Direction of null clearly shown on zero centered meter.
- Synchro zeroing without recourse to coarse and fine switching.

For further information contact your nearest representative or write for brochure

INDUSTRIAL TEST EQUIPMENT CO.
55 E. 11th ST. · NEW YORK 3 · GR. 3-4684
Circle 268 Readers Service Card

- Manufacturers of:
- PHASE METERS
 - NULL DETECTORS
 - IMPEDANCE COMPARATORS
 - POWER OSCILLATORS
 - FREQUENCY STANDARDS
 - AUTOMATIC HI-POT
- Other Electronic Test Equipment

NEW PRODUCTS (continued)

low power consumption, small space requirements and modular construction. Circle 476 on Reader Service Card.

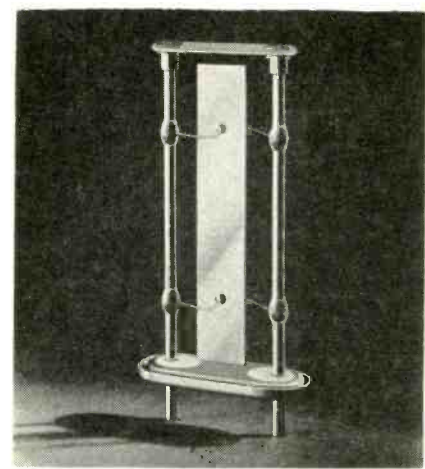

L-F CRYSTALS meet MIL specs

REEVES-HOFFMAN Div., Dynamics Corp. of America, Carlisle, Pa. These new low-frequency duplex crystal units are designed to provide accurate frequency control in the audio range of from 4 to 15 kc. Designated as type RH-8DP, they may be used in aircraft navigation equipment, telephone carrier systems, communication systems and test equipment. They are available in either standard 1½-in. HC-13/U metal holder, hermetically sealed, or in T6½ glass bulbs.

These crystals meet MIL C-3098 B specifications for shock, vibration, aging and moisture resistance. They are operable over a temperature range of -55 to +90 C with a stability of ±0.02 percent. Circle 477 on Reader Service Card.

LINEAR DEMODULATOR designed for servo systems

EMERSON ELECTRIC MFG. Co., Electronics and Avionics Div., Support Systems Laboratory, 8100 West Florissant Ave., St. Louis 21, Mo. Model IC-101 phase sensitive detector is a linear demodulator designed for high performance servo systems. Its principal feature is the combination of small time delay and low ripple component of

Little Mag says:



ENGINEERS-THERE IS ONLY ONE UNITIZED RECTIFIER® IT'S MAGNATRAN THE PACKAGE WITH A PURPOSE

Why not be the satisfied, worry-free Engineer who has provided for his company's own security, progress and savings? . . . You, too, can be the one to "choose and use"—Unitized Rectifiers®.

For AM, FM, TV and "over the horizon" transmitters—for Radar and Guided Missile Tracking—Hi-Voltage D. C. Equipment



Magnatran Unitized Rectifiers® are built in sizes to 500 KW capacity and to 250 KV, DC output—dry type—oil or Askarel. One Delivery—

Already Assembled—Unitized!!

Write for details—Ask for New Bulletin 57-00-A



MAGNATRAN incorporated
P.O. Box 211 KEARNY, NEW JERSEY, U.S.A.

For consistently high purity...

"LINDE" M.S.C. RARE GASES
Trade-Mark
(Mass Spectrometer Controlled)

- Helium
- Argon
- Neon
- Krypton
- Xenon

In radar electronic equipment, nuclear radiation counters, cosmic ray cloud chambers, and thyratrons, where the purest rare gases are demanded, LINDE M.S.C. Grade gases meet the specifications. They are produced under continuous mass spectrometer control to assure you of gases of known purity and consistently high quality. LINDE, the world's largest producer of gases from the atmosphere, can meet your individual needs of volume, mixture, and container.

For information on the physical, chemical, and electrical properties of these gases, send for the booklet, "LINDE Rare Gases."



LINDE COMPANY

Division of
Union Carbide Corporation
30 E. 42nd Street  New York 17, N.Y.

In Canada:
LINDE COMPANY, Division of Union Carbide
Canada Limited, Toronto

The term "Linde" is a registered trade-mark of Union Carbide Corporation.

Circle 270 Readers Service Card

WHERE PRECISION AND STRENGTH COUNT...

VIGOR Pliers Have the Edge

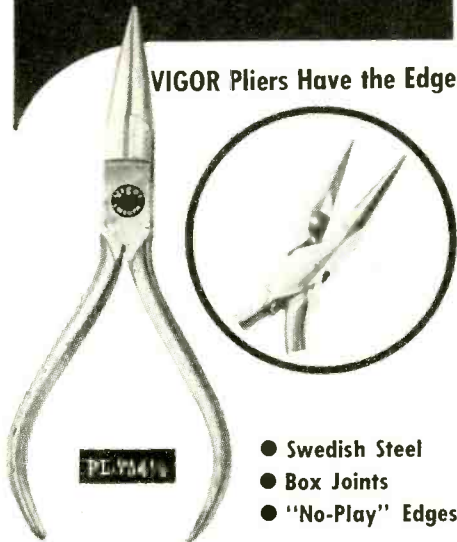

- Swedish Steel
- Box Joints
- "No-Play" Edges

Add up to life-time accuracy

Specially suited for miniature parts

Available in all styles — Sizes to six inches — Brochure on request.

B. JADOW, Inc.

860 Broadway, New York, N. Y.

Sold Through Electronic Wholesalers

Circle 271 Readers Service Card

ELECTRONICS — November 1, 1957

NEW PRODUCTS

(continued)

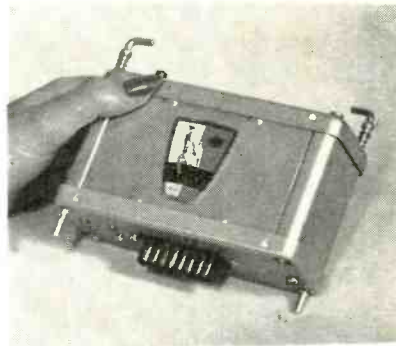

output. This particular model is designed for demodulating 400 cps carrier signals. Input signal range is from 0.025 to 15 v rms. The output ripple is less than 10 mv and the output impedance is 700 ohms.

Physically it is approximately 5 in. by 3 in. by 2 in. and weighs 15 oz. The PSD is mounted with "air-loc" fasteners to a mating Blue Ribbon connector which is supplied.

The basic circuit employed has been used by the company in many military applications such as the B-58 fire control system. Applications include recording instrumentation, servo detection, null indication and digiting. Circle 478 on Reader Service Card.

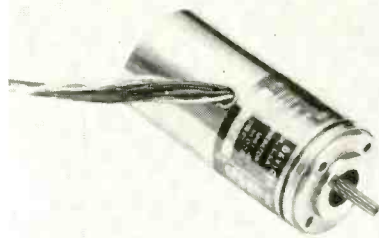

MOTOR TACHOMETER
new shorter version

EASTERN AIR DEVICES, INC., 385 Central Ave., Dover, N. H., has announced a shorter version of its size 11 motor tachometer. Shortened from 2.552 in. to 2.125 in., the new unit achieves improved electrical characteristics. This 115-v tachometer delivers 0.6 v per 1,000 rpm with 19 mv of total null. Lower nulls are readily available on request. Also of significance is the upper temperature rating of 150 C.

These units combine a high per-

Save space
with these
Johnson
miniature
capacitors!

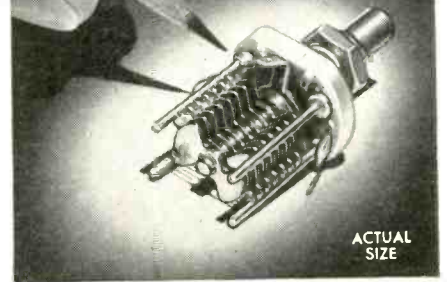

ACTUAL SIZE

Perfect for compact RF equipment . . .

These tiny variable capacitors provide the ideal solution to compact design problems. Requires just $\frac{5}{8}$ " x $\frac{3}{4}$ " panel area—the longest model extends only $1 \frac{17}{64}$ " behind panel. Soldered plate construction, oversized bearings, and heavily anchored stator supports provide extreme rigidity—torque is steady—rotor stays "put" where set! Bridge-type stator terminal provides extremely low inductance path to BOTH stator supports. Nickel-plated rotor contact—steatite end frames DC-200 treated. Single section, butterfly, and differential types available.

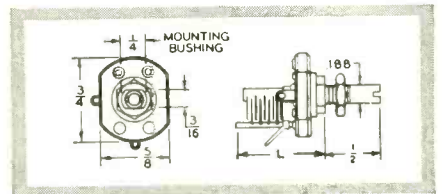

SPECIALS—Johnson Miniature Air Variables are available in production quantities with the following features: 1. Locking bearing. 2. 180° stop. 3. Various shaft extensions. 4. High torque. 5. Silver or other platings.

For complete information on these miniature capacitors or other Johnson electronic components—write for your free copy of our newest components catalog.

Free
Catalog

Contains complete specifications on all Johnson electronic components.



E. F. Johnson Company

2519 Second Ave. S.W. • Waseca, Minnesota

Circle 272 Readers Service Card

Pulse Notes



USING PULSE TRANSFORMERS IN TRANSISTOR CIRCUITS

The circuit diagram below illustrates the use of the new STAT-TRAN* Pulse Transformer in transistor blocking oscillator circuits.

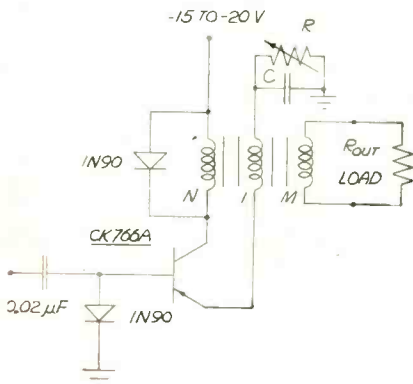

STAT-TRANS* used in the above circuit are identified on the basis of primary inductance measured at 1kc @ 0.04 v rms. The STAT-TRAN* has 4:1 pulse forming windings where the 4N winding is in the collector and the 1N winding is in the emitter. The circuit above was chosen because it requires a low level trigger of less than 0.5 v from a high impedance input and produces a low impedance output pulse essentially equal to the supply voltage.

The STAT-TRAN* transformer excels in this circuit because:

1. The coil is wound on a flat bed which gives better control of leakage and distributed capacity.
2. The core material is of extremely high permeability (2400 μ) which provides for the highest flux density and lowest core losses.

Write today for your free copy of our new 12 page catalog giving complete specifications on pulse transformers and filters as well as outlining typical circuitry and applications.

*REG. TRADE NAME

3

Pulse Engineering



2657 Spring Street
REDWOOD CITY
CALIFORNIA

Circle 273 Readers Service Card

NEW PRODUCTS

(continued)

formance servo motor and a low inertia drag cup damping tachometer generator. They are available in a great many variations including voltage and power ratings aimed at transistor operation, special lead locations, the incorporation of precision gearheads which facilitate the mechanical design of servo systems, and adaptation to unusual environmental requirements.

The new improved modification of the size 11 motor tachometer meets Bureau of Ordnance Mark 14 specifications. Circle 479 on Reader Service Card.

POWER SUPPLY

switching transistor type

ARNOLD MAGNETICS CORP., 4613 W. Jefferson Blvd., Los Angeles, Calif., has announced a 60-w switching transistor power supply that is regulated against both line and load variations simultaneously. Featured are small size and outstanding reliability.

The unit is used in aircraft, missile and commercial fields as a lightweight replacement for rotating equipment having 150 and 300 v d-c outputs. Bulletin 591-A is available. Circle 480 on Reader Service Card.

ELECTROMETER

vibrating capacitor type

NUCLEAR CORP. OF AMERICA, INC., 33-61 Crescent St., Long Island City 6, N. Y. The NUCOR vibrating capacitor electrometer is useful in measurement of direct currents to 10^{-10} amperes; resistances to 10^{18} ohms. It features excellent zero stability ($\pm 100 \mu\text{v}$ in any 12-hour period). Model 33B has an input resistance of 10^{13} ohms. Model 33C's input resistance is 10^{16} ohms. Circle 481 on Reader Service Card.

D-C AMMETER

in two range combinations

SENSITIVE RESEARCH INSTRUMENT CORP., New Rochelle, N. Y. Model

Toroidal Winder

Exclusive
Representative
and Distributor
for U.S.A.

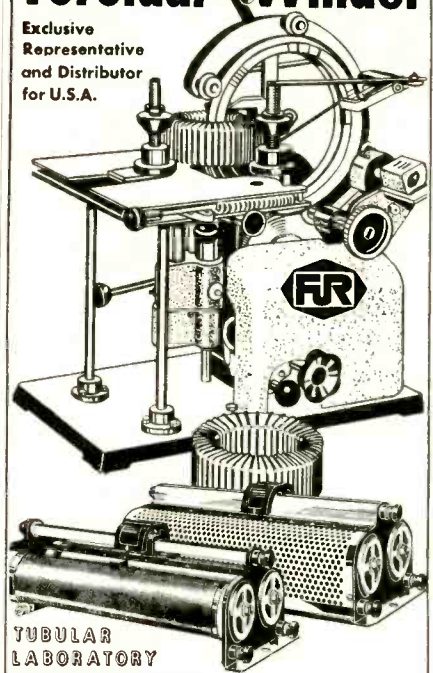

TUBULAR
LABORATORY
RHEOSTATS

INDUCTIVE & NONINDUCTIVE

REX RHEOSTAT CO.

BALDWIN, N. Y.

Circle 274 Readers Service Card

CABLE CLIPS

of all Nylon
for severe conditions

of Ethyl
Cellulose
for maximum
economy

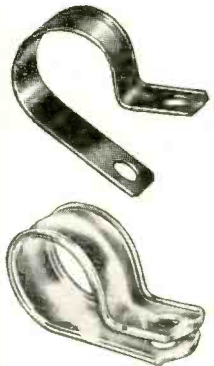

WECKESSER



molded
Black Nylon
SCREWS
and NUTS

- ★ Acid resistant
- ★ Need no insulation
- ★ Can't rust
- ★ Can't corrode

WECKESSER COMPANY
5701 Northwest Highway • Chicago 30, Ill.

Circle 275 Readers Service Card

November 1, 1957 — ELECTRONICS

CHC is a direct reading heavy current d-c ammeter. It is available in two ranges: 0/1/5/10/20/50/100 amperes; and 0/1.5/3/7.5/15/30/75 amperes. Accuracy is 0.2 percent. Scale length is 6.3 in. Weight is 21 lb. Size is 16 $\frac{3}{8}$ in. by 10 $\frac{1}{2}$ in. by 8 $\frac{3}{4}$ in. high. Price is \$750. Literature may be obtained on request. Circle 482 on Reader Service Card.

TINY TRANSFORMER

700 weigh less than 1 lb

GRAMER-HALLDORSON TRANSFORMER CORP., 2734 N. Pulaski Rd., Chicago 39, Ill., announces the release of the new Teenyformer, which is so small that it is completely hidden by the normal eraser on a lead-pencil. Designed for transistor applications, these transformers measure only 0.203 in. by 0.297 in. by 0.297 in. Circle 483 on Reader Service Card.

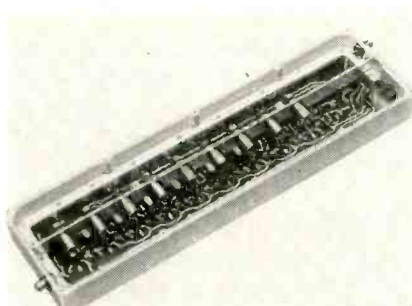

I-F AMPLIFIER

transistorized

LEL, INC., 380 Oak St., Copiague, L. I., N. Y., has introduced a new version of its series 80 transistorized i-f amplifiers. These units are now offered at frequencies up to 60 mc using either silicon or germanium transistors. Typical gain is 100 db, bandwidth 3 mc at 30 mc center frequency. Components are mounted on a printed circuit board which is supported in a cast aluminum frame. Electrical characteristics of the unit can be modified to meet specific application requirements. Reduced power, ruggedness and elimination of heat dissipation problems are some of the advantages obtained by their use in missile or radar systems. Circle 484 on Reader Service Card.

★ ULTRA LOW capacitance & attenuation

TYPE	$\mu\text{F}/\text{ft}$	IMPED. Ω	O.D.
C 1	7.3	150	.36
C 11	6.3	173	.36
C 2	6.3	171	.44
C 22	5.5	184	.44
C 3	5.4	197	.64
C 33	4.8	220	.64
C 4	4.6	229	1.03
C 44	4.1	252	1.03

WE ARE SPECIALLY ORGANIZED TO HANDLE DIRECT ORDERS OR ENQUIRIES FROM OVERSEAS

SPOT DELIVERIES FOR U.S.

BILLED IN DOLLARS—
SETTLEMENT BY YOUR CHECK

CABLE OR AIRMAIL TODAY

TRANSRADIO LTD. 138A Cromwell Rd. London SW7 ENGLAND

Circle 276 Readers Service Card

GUARANTEED

to meet all military environmental specs.

G-M specializes in the design and manufacture of servo motors for military uses. Readily available, both in standard sizes and as special units, these precision-built motors meet *all* military specifications for altitude, high and low temperatures, vibration and shock, humidity and salt spray.

G-M Servo Motors

manufactured by the Components Division of
G-M LABORATORIES INC.

4336 N. Knox Avenue • Chicago 41

Write Now

for G-M charts, specifications and performance data. No obligation, of course.

BLILEY CRYSTALS-BLILEY OVENS

Combine for Greater Stability.....

New Literature

BLILEY CRYSTALS • BLILEY OVENS

NEW BLILEY BULLETIN

Bliley

REQUEST BLILEY BULLETIN #507.

BLILEY ELECTRIC COMPANY
UNION STATION BLDG. • ERIE, PA.

The inherent frequency stability of Bliley crystals is greatly enhanced by temperature control. Bliley builds various types of crystal ovens for this purpose. A new bulletin showing the combined performance of Bliley crystals and ovens is available.

Circle 278 Readers Service Card

NEW cathode ray indicator by TECHNITROL

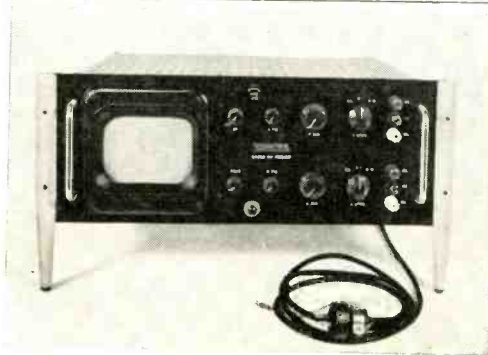

The Technitrol Cathode Ray Tube indicator provides a visual indicating device for the dynamic display of electrical signals. It is intended primarily as an output indicating device for such instruments as the Technitrol Dynamic Diode Tester and transistor curve tracers, no internal sweep circuits being provided.

This new indicator makes an excellent display unit for analogue computer and other applications where the repetitive

cycle rate of the display is consistent with screen persistences of available five-inch cathode ray tubes.

High-quality, conservatively-rated components assure a stable instrument which provides a very sharp focused beam on the face of the cathode ray tube.

Designed for standard 19" relay rack mounting, separate mounting legs are available at small additional cost.

- Equipped with identical high-gain DC-coupled amplifiers on both axes.
- Amplifier band widths: 3 db down at 110 kc; 6db down at 200 kc.
- Sensitivity: 7 millivolts rms per cm on horizontal channel; 5 millivolts per cm on vertical.
- Amplifiers provided with either single-ended or balanced inputs.



MANUFACTURERS OF PULSE TRANSFORMERS, DELAY LINES AND ELECTRONIC TEST EQUIPMENT

Circle 279 Readers Service Card

Parabolic Reflectors. Andrew Corp., 363 E. 75th St., Chicago 19, Ill. Bulletin No. 8438 covers the company's heavy gage aluminum parabolic reflectors for experimental and special microwave work. Included are listings of diameters, focal lengths, type numbers and prices. **Circle 501 on Reader Service Card.**

Electromagnetic Flow Meters. Nuclear Corp. of America, Inc., 33-61 Crescent St., Long Island City 6, N. Y. Brochure 1200 is a six-page folder illustrating and describing the Magnaflow, a precision flow measuring instrument that converts, without inherent pressure drop, a liquid flow velocity instantly into a proportional voltage. Operating principles and specifications are given. **Circle 502 on Reader Service Card.**

Automatic Capacitance Bridge. Simmonds Aerocessories, Inc., Tarrytown, N. Y. Publication No. AD401-10 deals with the part No. 387011 automatic capacitance bridge designed for measuring aircraft fuel gage system capacitances. It contains information on applications, range, accuracy, power, mounting, dimensions and weight. Operating instructions are included. **Circle 503 on Reader Service Card.**

Precision Wire Wound Resistor. Eastern Precision Resistor Corp., 675 Barbey St., Brooklyn 7, N. Y., has available a brochure describing the Comp-U-Trim 113, a new adjustable precision wire wound resistor with a precise trimming pot imbedded within its body. The component described is ideally suited for computers, voltage dividers, computer integrating networks, summing networks, tuned circuits, variable RC networks and matched resistance networks. **Circle 504 on Reader Service Card.**

Pulse Circuit Components. CBC Electronics Co., Inc., 2601 North Howard St., Philadelphia 33, Pa. Bulletin No. 731 gives complete engineering data on miniature and

subminiature pulse circuit components for radar, computers, and similar applications. Pulse transformers, packaged blocking oscillator circuits, and pulse circuit engineering kits are fully described with illustrations, dimensional data, and performance characteristics. Information formerly contained in bulletins BO and KA is brought up to date and condensed in two pages for quick reference. **Circle 505 on Reader Service Card.**

Electronic Lead and Hook-Up Wire. Belden Mfg. Co., P. O. Box 5070A, Chicago 80, Ill. Bulletin 8050 features the addition of Teflon insulated types E and EE, Mil Spec 16878-B hook-up wire to extend the company's wire and cable line. Illustrated and described are all Mil Spec wires made by the company for the electronic industry. **Circle 506 on Reader Service Card.**

H-V Power Supply. The Victoreen Instrument Co., 5806 Hough Ave., Cleveland 3, Ohio, has announced a new illustrated specification bulletin on the model 683 high-voltage power supply. Form 3000-7 "Victoreen Ultra-Stable Power Supply" covers principles of operation, gives suggested uses for the ultra-stable power supply, and lists detailed electrical and mechanical specifications. **Circle 507 on Reader Service Card.**

Data Reduction Systems. Fischer & Porter Co., Hatboro, Pa. Catalog 30A1200 is a six-page folder illustrating and describing the series 1200 industrial data logger and alarm scanner. Chief features of the system discussed include modular plug-in construction and flexible programming. **Circle 508 on Reader Service Card.**

Transistor Replacement Chart. Bendix Aviation Corp., Red Bank Division, Long Branch, N. J., has available copies of a new transistor replacement chart which gives information about the correct Bendix transistor to use when replacing weak or burned out transistors with Bendix units. Charts are available on request. **Circle 509 Reader Service Card.**

NEW FREQUENCY DOUBLERS

- Double the sampling rate
- Double the band width
- Eliminate zero offsets

DC-AC CHOPPERS

Twenty-two types, both single and double pole.

Long life.

Low noise level.

Extreme reliability.

Write for Catalog.

STEVENS INCORPORATED ARNOLD

7 ELKINS STREET
SOUTH BOSTON 27, MASS.

S/A-10C

Circle 280 Readers Service Card

AUGAT'S NEW TRANSISTOR CLIPS

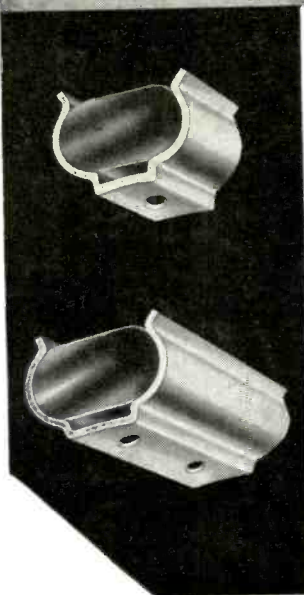

Augat Brothers have developed a new line of clips for the retention of transistors, crystals, diodes, etc.

Now available in all standard sizes, they are the answer to the engineers' layout problems in regards to shock and vibration. Made of either 1065 spring steel or 25 alloy beryllium copper to retain shape, a minimum of clamping action is lost in use.

If your requirements are not listed in our catalog, write us for information on clips made to your specifications.

AUGAT BROS. INC.
31 PERRY AVENUE • ATTLEBORO, MASS.

Circle 281 Readers Service Card

359

Plants and People

Edited by WILLIAM P. O'BRIEN

Electronics manufacturers expand plants and facilities by acquisition, leases or new construction. Top engineers and executives in the industry are promoted and move to new responsibilities. IRE names top award winners

Mt. Vernon Firm Quintuples Facilities

DEL ELECTRONICS CORP. has moved its operations to a new two story building at 521 Homestead Ave., Mt. Vernon, N. Y. The company is engaged in the design and manufacture of h-v power supplies and transformers to 200 kv up to 20 kva.

The new building provides the company with five times its former production facilities. Space has been allotted for research and development work and for a classified area for use in connection with an access permit recently granted the company by the Atomic Energy Commission.



Del Electronics Corporation's new quarters

Westinghouse Expands with Microwave Industry



Westinghouse plant expansion in Maryland

THE carrier-microwave department of Westinghouse Electric Corp. has expanded facilities in Halethorpe,

Md., by constructing a new, modern office building adjacent to the manufacturing plant.

Many processes such as coil winding, filter making, and wiring, formerly accomplished elsewhere, are now done within the plant. Future plans for the shop include facilities for internal production of fabricated parts requirements.

Nems-Clarke, Inc. Joins Vitro Corp.

AS of September 1, Nems-Clarke, Inc., electronic manufacturers in Silver Springs, Md., became an operating division of Vitro Corp. of America. The company now is known as Nems-Clarke Co. Allen S. Clarke remains as president of the company. Ralph E. Harmon is vice president.

Allen Clarke has stated that the new affiliation will result in expanded manufacturing and deve-

310D

No. 1 solution to dielectric problems—

PRECISION STEATITE by GENERAL CERAMICS

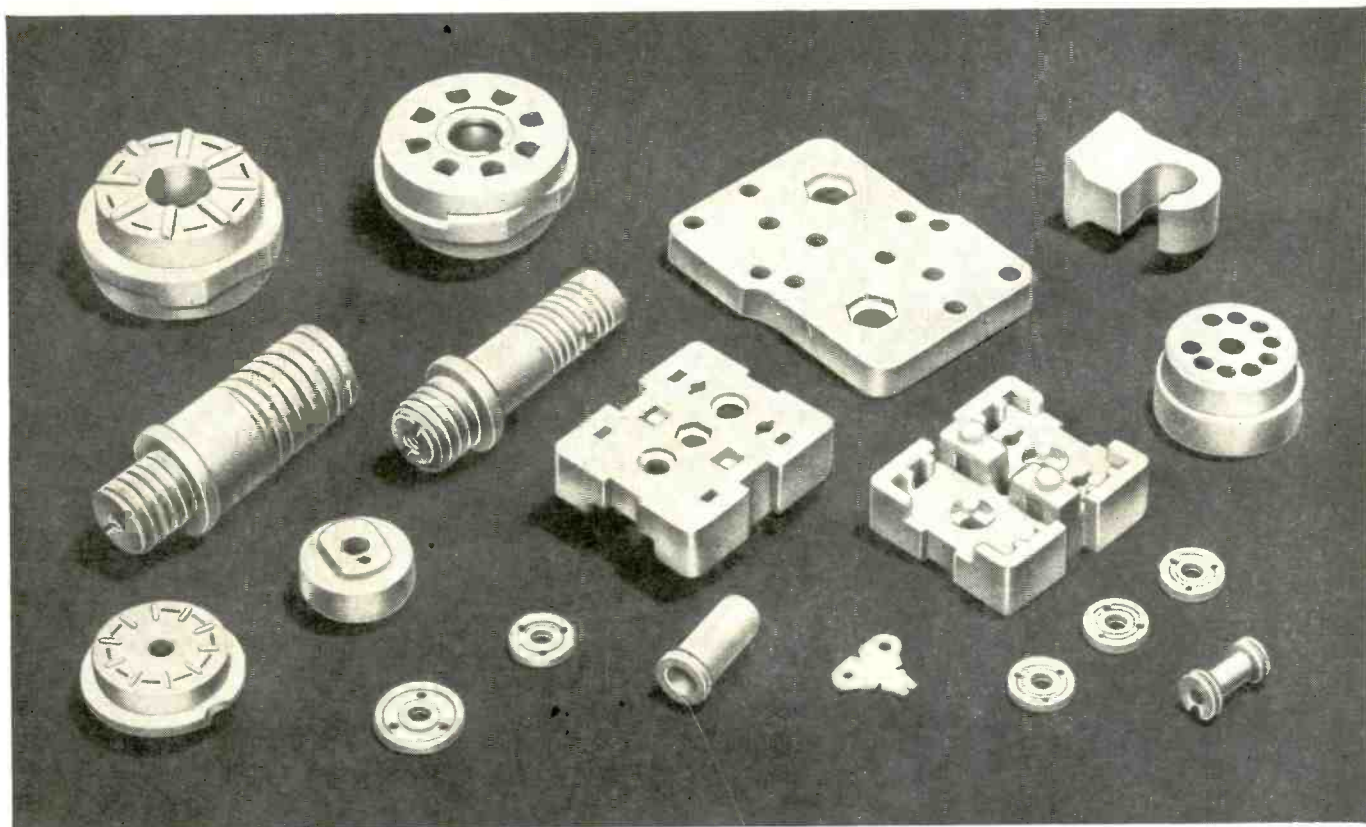

G-C steatite solves all of these problems...economically

- ▶ Widely varying ambient temperature
- ▶ Severe mechanical or thermal shock
- ▶ Permanence of dimensional accuracy
- ▶ Intricate shapes to close tolerance
- ▶ Efficient compaction of physical size
- ▶ Low electrical loss at high frequency
- ▶ High dielectric and mechanical strength
- ▶ Extreme immunity to environmental conditions

G-C electrical ceramics are news! Offering a far higher degree of dimensional accuracy than ever before possible, *precision* dielectrics provide a far greater design latitude in all types of electronic and electrical equipment. These new high accuracy ceramics are another example of

General Ceramics progressive manufacture . . . better products at lower cost through advanced research and improved methods of production. Why not ask for all the facts on *precision* electrical ceramics, now! Write General Ceramics Corporation, Keasbey, New Jersey, Dept. E.

GENERAL CERAMICS

Industrial Ceramics for Industrial Progress... Since 1906



FERRAMIC CORES



FERRAMIC
MAGNETIC CORES

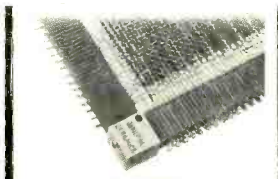

MAGNETIC
MEMORY PLANES



"ADVAC" HIGH
TEMPERATURE SEALS

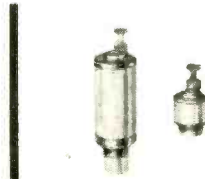

SOLDERSEAL TERMINALS

ment activity. A reorganization of the development laboratory is in process to broaden the base of the company's proprietary products.

While some changes in personnel

will be necessary in order to accomplish this reorganization, such changes will be kept to a minimum. The company expects to greatly expand its development activity for

the creation of new products in the fields of telemetry, medical electronics, photographic instrumentation, and communications equipment.

RIC Expands Engineering Facilities

H. A. BOGUSLAWSKI, vice president-engineering-sales of Rocke International Corp., New York, N. Y., has announced the following appointment: Baron C. de Beer is the new chief engineer, broadcast and communications. Before joining RIC he was associated with the Rediffusion group of companies (England) for a number of years and held the appointment of assistant chief engineer of the Jamaica Broadcasting Co. Prior to that he served for ten years in the communications branch of the RAF and held a commission as a Signal's officer. In this new capacity he will be responsible for the technical supervision and administration of both the broadcast and communications departments.

Maxwell C. Zeile moves to field engineering manager; in this ca-

capacity he will tour the overseas branches and agents making himself available for technical and commercial consultations. Before joining RIC in 1954, Zeile already had many years of experience in communications techniques. He also was chief of Instrument Laboratories for ISE in Argentina.

Electron Corporation Names Vice-President

FRANK BISCARDI has been named vice-president of the Electron Corp., a subsidiary of Ling Industries, Inc. He has been production manager of the corporation, which develops and manufactures closed-circuit tv cameras, since November 1956.

He was formerly electronics production engineer with General Electrodynamics Corp. in Garland, working on the development of the

Vidicon type camera tube, and in charge of all phases of cathode-ray-tube production for Haydu Bros. of New Jersey, a subsidiary of Burroughs Business Machines.

IRE Names Top Award Winners

ALBERT W. HULL, consultant to the GE Research Laboratory, and W. R. G. Baker, vice-president of GE, were among those named to receive the 1958 awards of the IRE.

Dr. Hull was named to receive the Medal of Honor, the highest technical award in the radio-electronics field "for outstanding scientific achievement and pioneering inventions and development in the field of electron tubes."

The Founders Award, bestowed only on special occasions to outstanding leaders in communica-

Board of Directors and Officers of EIA 1957-58



Ask yourself
why do you hesitate?

Take any One

OF THESE BOOKS

FREE

with membership in

McGraw-Hill's Book Club for
Electronics and Control Engineers



COUNTLESS Electronics and Control Engineers find these important technical books indispensable to a field so dynamic that even specialists can hardly keep up!

How many of the books shown here do you wish you had immediately at hand? We invite you to take one AS A GIFT and one as your first selection . . . your introduction to a technical reading program that cannot fail to be of value to you.

The McGraw-Hill Electronics and Control Engineers' Book Club was organized for engineers like yourself to bring to your attention outstanding books in your field that you might otherwise miss. The twelve books shown above suggest the quality of the volumes that will be made available to you. And you may obtain any or all selections at substantial savings.

How the Club operates. The Club will describe all forthcoming selections to you. Every second month you will receive the *Electronics and Control Engineers' Book Club Bulletin*. This gives complete advance notice of the next main selection as well as a

number of alternate selections. All books are chosen by editors of the McGraw-Hill Book Company whose thoroughgoing understanding of the standards and values of technical literature will be your guarantee of the authoritativeness of the selections.

From this point on, the choice is yours. If you want the main selection you do nothing; the book will be mailed to you. If you want an alternate selection or if you want no book at all for that two-month period, you notify the Club by returning the form and postage-paid envelope enclosed with your *Bulletin*.

We ask you to agree only to the purchase of three books a year. Certainly out of the large number of books in your field offered you in any twelve months there will be at least three *you would buy in any case*. By joining the Club you will save, in cost, about 15 percent from the publishers' prices.

It's up to you. Reach for your pen right now and fill out the coupon. You need send no money now. Remember, by taking advantage of this special introductory offer you will receive absolutely FREE any one of these books, together with your first selection—at the special club price.

So while this offer is in effect, put your application form in the mail today!

Mail Entire Coupon to:

The McGraw-Hill Electronics and Control Engineers' Book Club
330 West 42nd Street, New York 36, N. Y. P. O. Box 97

Please enroll me as a new member of the Electronics and Control Engineers' Book Club. I am to receive FREE the book I have indicated along with my first selection checked below. You will bill me for my first selection only at the special club price, plus a few additional cents for postage and handling. (The Club assumes this charge on prepaid orders.) Forthcoming selections will be described to me in advance and I may decline any book. I need take only 3 selections or alternates in 12 months of membership.

- Pulse and Digital Circuits** by Jacob Millman, Professor of Electrical Engineering, Columbia University and Herbert Taub, Associate Professor of Electrical Engineering, The City College of New York. Publisher's Price, \$12.50. Club Price, \$10.00.
- Modern Physics for the Engineer** edited by Louis N. Ridenour, Vice President, International Telemeter Corporation. Publisher's Price, \$8.00. Club Price, \$6.80.
- Electronic Analog Computers**, 2nd Ed., by Granino H. Korn and Theresa M. Korn, Industrial Consultants. Publisher's Price, \$7.50. Club Price, \$6.40.
- Mechanical Design for Electronics Production** by John M. Carroll, Associate Editor, *Electronics*. Publisher's Price, \$6.50. Club Price, \$5.50.
- Contracts, Specifications and Engineering Relations**, 3d Ed., by Daniel W. Mead, rewritten by the Staff of Mead and Hunt, Inc., and Joseph R. Akerman, Revisions Editor and Principal Author. Publisher's Price, \$7.00. Club Price, \$5.95.
- Random Processes in Automatic Control** by J. Halcombe Laming, Jr., Deputy Associate Director and Richard H. Battin, Assistant Director, Instrumentation Laboratory, Massachusetts Institute of Technology. Publisher's Price, \$10.00. Club Price, \$8.50.
- Institute of Technology**. Publisher's Price, \$10.00. Club Price, \$8.50.
- Transistors in Radio and Television** by Milton S. Kiver, Author of *Color Television Fundamentals*. Publisher's Price, \$6.50. Club Price, \$5.50.
- Servomechanism Practice** by W. H. Ahrendt, President, The Ahrendt Instrument Company. Publisher's Price, \$7.50. Club Price, \$6.35.
- Automatic Feedback Control System Synthesis** by John G. Truxal, Professor and Head, Dept. of Electrical Engineering, Polytechnic Institute of Brooklyn. Publisher's Price, \$12.50. Club Price, \$10.00.
- Electronic and Radio Engineering**, 4th Ed. by Frederick E. Terman, Dean, School of Engineering, Stanford University. Publisher's Price, \$13.50. Club Price, \$11.50.
- Analog Computer Techniques** by Clarence L. Johnson, Captain, U. S. Air Force; Assistant Professor of Mathematics, U. S. Air Force Institute of Technology. Publisher's Price, \$6.00. Club Price, \$5.10.
- Introduction to Numerical Analysis** by F. D. Hildebrand, Associate Professor of Mathematics, Massachusetts Institute of Technology. Publisher's Price, \$8.50. Club Price, \$7.25.

No-risk guarantee. If not completely satisfied, I may return my first shipment within 10 days and my membership will be canceled.

Name (Please Print)
Address
City Zone State

This offer is available only in the United States and its possessions.
In Canada write McGraw-Hill Canada, 253 Spadina Road, Toronto 4.

GE THYRITE® VARISTORS CUT SURGE VOLTAGE

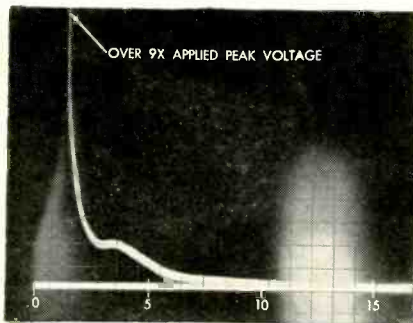

**FROM 9 TO 3 TIMES
APPLIED PEAK VOLTAGE**

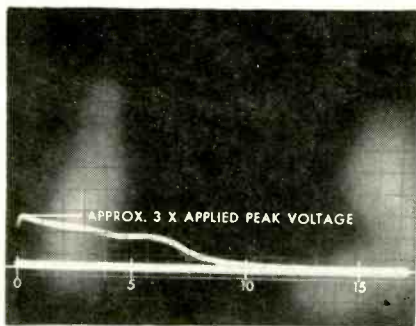

ON 115-V CIRCUITS

Sudden interruption in inductive current causes surge overvoltage, arcing, and high-frequency oscillation. Oscillograms (above) show how effectively G-E Thyrite varistors can limit these effects.

Without a Thyrite varistor (Fig. 1) in the 115-V circuit, surge voltage is 9 times applied peak voltage. With it (Fig. 2), surge voltage is limited to 3 times peak voltage.

With little current drain, they reduce surge voltage and arcing by offering low resistance at peak current . . . discharge circuit energy faster by offering higher resistances instantaneously as current decays.

G-E Thyrite varistors are available for components rated from 6 volts to 4000 volts.

For more information, or Thyrite varistor test kits, write: *Magnetic Materials Section, General Electric Company, 7806 N. Neff Road, Edmore, Michigan.*

THYRITE VARISTOR KITS



Kit No. 1: 1/2" dia. disks—2 each of 6 ratings (6V to 115V—.1w); color coded with connecting leads. Price: \$5.00.



Kit No. 2: 1/4" dia. rods—2 each of 5 ratings (115V to 4000V—.25w); color coded with connecting leads. Price: \$5.00.

Progress Is Our Most Important Product

GENERAL GE ELECTRIC

"Thyrite" is a trademark of General Electric Company

Circle 288 Readers Service Card



A. W. Hull



W. R. G. Baker

tions and electronics, will be given to Dr. Baker "for outstanding contributions to the radio engineering profession through wise and courageous leadership in the planning and administration of technical developments which have greatly increased the impact of electronics on the public welfare."

Recipient of the Morris Liebmann Memorial Prize will be Edward L. Ginzton, Professor of Applied Physics and Electrical Engineering, Stanford U., "for his creative contribution to the gen-

eration and useful application of high energy at microwave frequencies."

Edward W. Allen, Jr., chief engineer of the FCC, was named to receive the Harry Diamond Memorial Award "for his technical and administrative contributions in the field of radio spectrum utilization."

The Vladimir K. Zworykin, Television Prize will go to Charles P. Ginsburg, Ampex Corp., Redwood City, Calif., "for pioneering contributions to the development of video magnetic recording."

Norden-Ketay Divisions Get New Buildings

RECENTLY Norden-Ketay's two Long Island divisions, Precision Components Division and Gyromechanisms Division, completed their moves to new, modern quarters.

A 31,000-sq ft addition to the corporation's Precision Components Division at Commack represents a 36-percent increase to that division and brings total area to over 85,000 sq ft.

Gyromechanisms Division moves to a modern, new 17,000 sq ft building at Huntington Station.

The addition to Precision Components Div., and the new Gyromechanisms Plant will replace temporary or geographically separated facilities and will consolidate the operations of each division in fully integrated plants.

Norden-Ketay, with headquarters in Stamford, Conn., has other divisions in Milford, Conn., White Plains, N. Y., Miami, Fla., and Gardena, Calif.

Missile Test Chief Named at Farnsworth

LAWRENCE G. HAGGERTY, president of Farnsworth Electronics Co., has announced that Vernon L. Haag has joined the firm as vice president in charge of missile test equipment.

Farnsworth, a division of IT&T Corp., is a major contractor supplying test equipment for the Bomarc missile system and other development projects in the U. S. Government's program of national defense.

Haag comes to Farnsworth from

the Gray Mfg. Corp. of Hartford, Conn., where for the past ten years he has been vice-president in charge of operations in the fields of engineering and manufacturing. He also was a member of the board of directors at Gray.

Previously, Haag held top management and chief engineering positions with Aerovox Corp., Sperry Gyroscope, Crosley Radio Corp., and Elgin Watch Co.

Brown Moves Up at RCA



G. H. Brown

APPOINTMENT of George H. Brown as chief engineer, Industrial Electronic Products, RCA, has been announced.

Since last January, Dr. Brown has served as chief engineer of the former RCA Commercial Electronic Products unit, which has been incorporated in the new Industrial Electronic Products organization.

In his new capacity, he will have engineering responsibility for all RCA industrial equipment and systems, including broadcast, communications, and industrial electronic equipment, and computer, telecommunication, and industrial control systems.

Acoustica Associates Inc. Takes New Quarters

ON SEPTEMBER 1, Acoustica Associates, Inc. — designers and manufacturers of ultrasonic cleaning units, ultrasonic soldering

0 CPS to 1 MC!
DIRECT READING



new
Computer-Measurements Model 226A

UNIVERSAL COUNTER-TIMER

OUTSTANDING FEATURES:

- ★ Three independent, adjustable trigger level controls permitting full rated sensitivity at any voltage level between -300 and +300 volts.
- ★ Small voltage increments ordinarily masked by attenuators are easily selected.
- ★ Simplified color-coded controls and direct read-out in kc, mc, sec, or millise, with automatic decimal point indication.
- ★ Oscilloscope marker signals facilitate start and stop trigger level adjustment for time interval measurement of complex waveforms.

A brand new, multi-purpose instrument provides precision measurement of frequency, frequency ratio, period (1/frequency) and time interval. Pressure, velocity, acceleration displacement, flow, RPS, RPM, etc., may also be measured with suitable transducers. The 226A may be used as a secondary frequency standard.

price: \$1,100.00

Long Term: 3 parts per million per week

Display Time: Automatic: Continuously variable 0.1 to 10 seconds
Manual: Until reset

Input Impedance: 1 megohm and 50 mmf

Trigger Level: Continuously adjustable from -300 to +300 volts

Accuracy: ± 1 count \pm stability

Secondary Frequency Standard: 1 mc; 100, 10, 1 kc; 100, 10, and 1 cps

Dimensions: 17" W x 8 $\frac{3}{4}$ " H x 13 $\frac{1}{2}$ " D approx.

Weight: 50 lbs. approx.

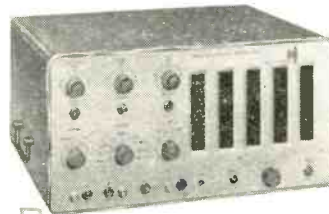

MODEL 225A 0 cps-100 kc UNIVERSAL COUNTER-TIMER

Similar to the 226A in design. Featuring Oscilloscope Trigger Level Marker Signals; Three Direct-Coupled Inputs of 70 mv sensitivity; Direct Reading, Automatic Illuminated Decimal Point. Easily portable. Price: \$840.00

Data Subject to Change Without Notice — Prices F.O.B. Factory

Write for complete specifications on the new 226A and the 225A models and the complete CMC line of electronic counting and controlling equipment.

Computer-Measurements Corporation
5528 Vineland Avenue, North Hollywood, Calif. Dept. 78-N

FREQUENCY

SPECIFICATIONS:

FREQUENCY MEASUREMENT

Frequency Range:
0-1,000,000 cycles
per second

Input Sensitivity:
0.2 volt rms.
Direct-coupled input

Time Bases:
0.00001, 0.0001, 0.001,
0.01, 0.1, 1 and 10
seconds. Also can use
external 0-1 mc standard

PERIOD MEASUREMENT

Period Range:
10 microseconds
to 1,000,000 seconds

Frequency Range:
0.000001 cps to 100 kc

Input Sensitivity:
0.2 volts rms.
Direct-coupled input

Gate Times:

1 and 10 cycles of
unknown frequency

Standard Frequency Counted:

1 mc; 100, 10, 1 kc;
100, 10, 1 cps;
external 0-1 mc.

TIME INTERVAL MEASUREMENT

Range:
3 microseconds to
1,000,000 seconds

Start and Stop:

Two independent or
common channels
Positive or negative slope

Input Sensitivity:
0.2 volts rms.

Direct-coupled input

Standard Frequency Counted:

1 mc; 100, 10, 1 kc;
100, 10, 1 cps; external 0-1 mc.

GENERAL

Stability:

Short Term: 1 part in
1,000,000 (temperature-
regulated crystal)

FREQUENCY • TIME INTERVAL • PERIOD • FREQUENCY • TIME INTERVAL • PERIOD • FREQUENCY • TIME INTERVAL • PERIOD • FREQUENCY

PERIOD • TIME INTERVAL • FREQUENCY • PERIOD • TIME INTERVAL • PERIOD • FREQUENCY

CMC

CC-30

**now! a low cost
gasoline/oil resistant
insulated wire . . .
the NEW Nylon-jacketed**

CONTINENTAL PETROL WIRE

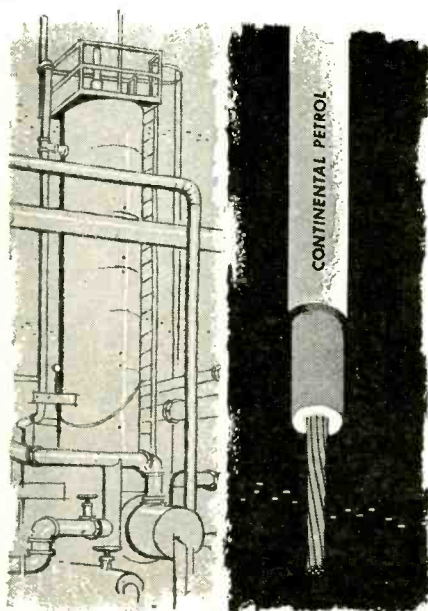

APPROVED BY
UNDERWRITERS' LABORATORIES, INC.

Looking for a low-cost gasoline and oil resistant insulated wire? An insulated wire approved for use in wiring gasoline pumps and in refineries BUT at lower cost than lead jacketed rubber insulation? Then you've been looking for this NEW Continental PETROL wire.

Nylon-jacket over thermoplastic insulation, PETROL wire is not affected by most oils, acids and alkalis. It is approved by Underwriters' Laboratories for 30°C in gasoline . . . 60°C in oil or air.

Available in sizes from 14 to 6 AWG . . . in a rainbow-range of colors. For more information on the new Continental PETROL wire, outline your requirements in a letter and mail to us immediately.

A Continental field engineer will be glad to help with any insulated wire problem in your area.

FREE 72-page catalog of the complete line of Continental Insulated Wire and Cable available on request. Send for your copy today.

Continental

WIRE CORPORATION

**WALLINGFORD, CONNECTICUT
YORK, PENNSYLVANIA**

Circle 290 Readers Service Card

guns, liquid level sensors, and entire cleaning systems for industry—moved from Glenwood Landing to new and larger quarters at 26 Windsor Ave., Mineola, L. I., N. Y.

The greatly expanded facilities will enable Acoustica to meet the increased demand for their products.

Narda Promotes Robertson



Donald R. Robertson

PROMOTION of Donald R. Robertson to manager of The Narda Microwave Corporation's electrical assembly plant, Mineola, N. Y., has been announced. He has been plant manager of Kama Instrument Corp., Mineola, N. Y., since its acquisition by Narda in 1956, and previously was Kama's chief engineer. In his new capacity he will be responsible for both the planning and supervision of all Narda's electrical assembly operations.

Three Electronic Firms Merge

FORMATION of a new manufacturer of electrical and electronic components, known as National-El Ray Co., North Hollywood, Calif., has been announced. The new corporation combines the facilities and personnel of three existing companies: El Ray Motor Co., manufacturers of miniature a-c and d-c

motors; Valco Engineering Co., makers of ceramic capacitors; and National Electronics Corp., manufacturers of filters, transformers and electronic heating elements for aircraft and missiles.

Two plants occupied by the predecessor companies have been renovated and new production techniques, the latest testing equipment for quality control and inspection, and general organization of production line layouts have been completed.

The two plants are located at 11747 and 11845 Vose St. in North Hollywood.

Daystrom Systems Builds New Laboratory

CONSTRUCTION has begun on a modern electronic laboratory in La Jolla, Calif., by Daystrom Systems, for research and development in the field of advanced automation.

Daystrom Systems, division of Daystrom, Inc., is expected to move from present quarters in La Jolla to the first section of some 30,000 sq ft by the end of this year or early 1958.

The systems division is engaged in the advanced development of complete electronic systems for automatic control and data handling in the industrial, military and scientific fields.

Exec V-P Elected at AIL

ELECTION of Donald M. Miller, as executive vice-president of Airborne Instruments Laboratory, Mineola, N. Y., has been announced. He has been v-p in charge of the Engineering and Production Division of the company since 1946. AIL, organized in 1945, is active as a developer and manufacturer of military radar and electronics equipment as well as aviation instrumentation and industrial automation equipment.

In his new position Miller will, under the direction of Hector R. Skifter, president of AIL, assume responsibility for the overall direction and control of the company's



Donald M. Miller

operations. He will coordinate the activities of the various operating divisions and will be responsible for obtaining results in keeping with the company's policies and objectives.

Lynch Carrier Names Chief Network Engineer

LYNCH CARRIER SYSTEMS INC., manufacturers of telephone and telegraph carrier equipment, recently announced the appointment of Arie Slikkerveen, as chief network engineer, with responsibility for theoretical engineering design. He has been with the Lynch Co. for the past eight years in various responsible engineering capacities.

Airpax Appoints Chief Engineer

CLIFF N. WILLIAMSON was recently named chief engineer of the Central Engineering Division, Airpax Products Co., Fort Lauderdale, Fla. Williamson, who transferred to the Florida plant June 1, has supervised development of the company's line of Magmeter frequency detectors at the Middle River Plant in Baltimore, Md. Prior to that, he was senior vibrator engineer at the Cambridge Division, Cambridge, Md. He has carried out special studies of transistor power converters and development of magnetic components.

Before joining Airpax, William-



GREEN ENGRAVERS *are fast!*

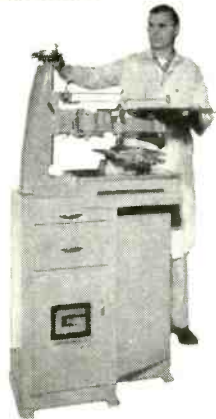

- Spindle speeds up to 26,000 rpm to engrave or for machining modern materials
- Fastest possible copy set-up
- Greatest ease and speed of adjustments
- Cutter grinders, rotary tables, master letters, compound slides, name plate blanks and all required accessories

MODEL D2 HEAVY-DUTY 2-DIMENSIONAL

- 575 pounds-rigid, sturdy, precise
- Vertical adjustment of copy table automatic with Pantograph
- Unobstructed on three sides to take large work
- Vertical range over 10 inches
- Micrometer adjustment for depth of cut
- Ball bearing construction throughout — super precision ball bearings in spindle
- Ratios 2 to 1 to infinity — master copy area 26" x 10"

MODEL 106 PORTABLE BENCH MODEL-2- OR 3-DIMENSIONAL

- 40 pounds of unbeatable speed and accuracy at a reasonable price
- Perfect for all machining applications within its range
- Ball bearing spindle has three speeds up to 14,000 rpm
- 5 positive, accurate pantograph ratios
- One copy carrier (supplied) accept all master sizes
- Height of pantograph and position cutter are continuously adjustable
- Work up to 10" by any width
- Taper shank cutters

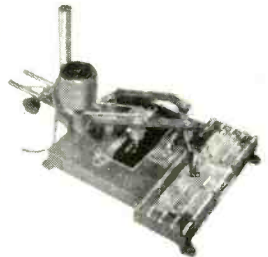

GREEN INSTRUMENT CO., INC.

363 Putnam Avenue

Cambridge, Mass.

Circle 291 Readers Service Card



SOMETHING TO CROW ABOUT

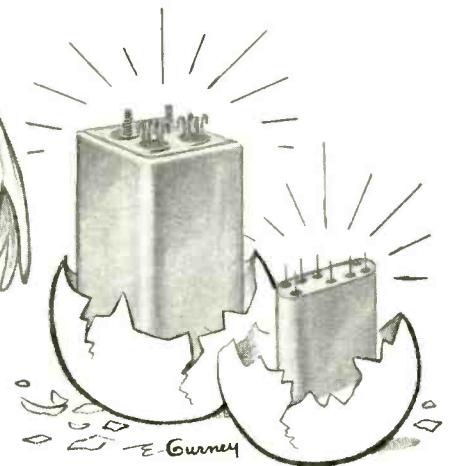

TWO RELAYS ABOUT TO HATCH!

a NEW Sensitive Relay with High Vibration Resistance

● a NEW Crystal Case Relay

Wheelock SIGNALS INC.
RELAYS  LONG BRANCH, N. J.

Malco IS YOUR
BEST SOURCE
FOR
SOLDERING LUGS
TERMINALS
PRINTED CIRCUIT
HARDWARE

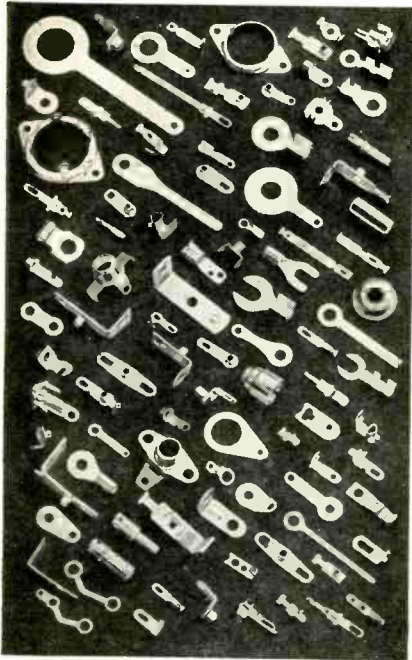

HERE'S WHY:

- Specialized high production techniques afford lowest possible unit cost.
- Precision tooling, rigid quality control assure tolerances to critical specifications.
- Ample stocks of over 1000 different parts permit prompt delivery.
- Malco specializes in a complete line of small stampings for Radio-TV, electrical/electronic and automotive industries.
- Our line includes terminals and printed circuit hardware in loose or in chain form for automatic insertion.

Let Malco show you how you can save on production time and costs. Contact us today.



Request handy reference catalog containing specifications on standard and custom-made lugs, terminals, corona rings, pins, contacts and similar stampings.

Malco TOOL and MANUFACTURING CO.
4023 W. Lake St., Chicago 24, Ill.
Circle 293 Readers Service Card



Cliff N. Williamson

son was vibrator engineer for Cornell-Dubilier and earlier for Radiart. From 1940 to 1946 he was with the Navy Dept. at Washington, D. C., with the Sonar Program.

Topp Establishes
Communications Division

H. J. PETERSEN, president, Topp Mfg. Co., Los Angeles, A Division of Topp Industries, Inc., Beverly Hills, Calif., has announced establishment of a new Communications Division. He also announced that an initial contract in excess of one million dollars has been awarded the division by the CAA for ground-station omnirange equipment.

The new section will concentrate on the design and manufacture of communication and navigation devices for airline, business and private aircraft; also commercial ground station traffic control equipment.

The new division will be housed in Topp's Plant No. 3 at 4949 W. 104th St., Los Angeles. The building, containing 5,400 sq ft of floor space, was leased by Topp less than a year ago to provide the firm with

New Plant for Ling Announced

LING ELECTRONICS, INC. has completed plans for expansion into a second, new plant in Los Angeles. The new buildings, located on a 150,000 sq ft site in Culver City will house administrative, engineering and sales as well as additional manufacturing facilities.

Ling Electronics specializes in the design and manufacture of

high-power electronic equipment, including electronically-driven random and sine wave vibration testing systems used in missile, jet and special industrial testing; radio transmitters, and sonar and ultrasonic generators.

Special emphasis in the new building has been placed on engineering accommodations.

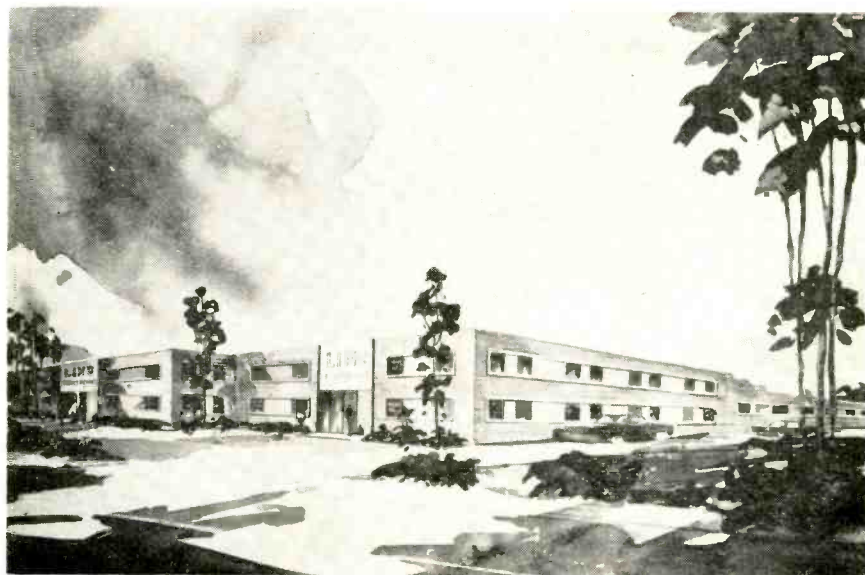

Ling's new quarters will look like this

MODERN COIL EQUIPMENT

Plus MODERN COIL HANDLING

Insure perfection in
all **DANO COILS**

- Specially Treated Coils
- Vacuum Impregnated Coils
- High Temperature Coils
- Encapsulated Coils
- Form Wound Coils
- Paper Interleave Coils
- Bobbin Coils

Also Transformers Made To Order



Circle 294 Readers Service Card

NEW CHRISTIE SILICON POWER RECTIFIERS

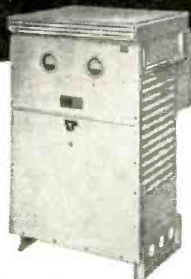

For Top Reliability

- A standard line from 30 to 1000 amps
- Closely regulated by magnetic control
- Voltages: 8-16-32-36
- Stationary or Mobile Types
- For Missile, Aircraft, Lab & Factory

Write for Latest Bulletins on
Silicon & Selenium Power Rectifiers

CHRISTIE ELECTRIC CORP.

Dept. EL, 3410 W. 67th St., Los Angeles 43

Over a Quarter Century of
Rectifier Manufacturing

Circle 295 Readers Service Card

ELECTRONICS — November 1, 1957

PLANTS AND PEOPLE

(continued)

expanded facilities for increased production.

Magnetic Core Moves

JOHN C. WEBB, president, Magnetic Core Corp., has announced the move of this company's general and executive offices from Ossining, N. Y., to their expanded manufacturing plant, John and Lawrence St., New Windsor, Newburgh, N. Y.

For many years this company has been a specialist in the manufacture of electronic powder metal-lurging.

IRE Establishes New Award

AN AWARD to be known as the Scott Helt Memorial Award has been established by the Administrative Committee of the Professional Group on Broadcast Transmission Systems of the IRE. This is the first Professional Group Award. It will be presented annually for the best paper published in the "Transactions" of the Group.

Scott Helt had been active in radio broadcasting and television for a period of 32 years until his untimely death in 1956. His last post was as patent administrator at Allen B. DuMont Laboratories, Inc.

Busse Joins Rheem Electronics

CLIFFORD A. BUSSE has been appointed engineering manager of the Electronic Division of the Rheem Mfg. Co., Rivera, Calif.

Prior to joining Rheem Electronics, Busse was with Farnsworth Electronics Co., a division of IT&T, where he served for six years in various management-technical capacities and most recently as assistant manager and chief engineer—missile test equipment.

Before his association with Farnsworth his experience included development work on industrial and broadcast equipment with

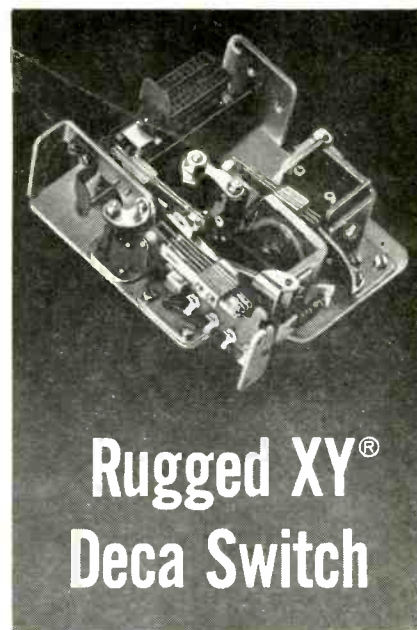

Rugged XY[®] Deca Switch

for your selecting and control operations

This direct-drive impulse-controlled stepping switch (reset type) is designed to perform control and selecting functions in industrial and communication applications.

The lightweight Deca Switch offers exceptional reliability and compact ruggedness, plus these added features:

- positive stepping action with special locking device to eliminate bounce of wipers and off-normal contacts when the switch returns to the home position;
- 4 banks of 11 contacts each;
- such time-proven XY advantages as dust-free vertical wire banks, bifurcated wipers, dependable release magnet mechanism, and long-wearing, case-hardened working parts with Parco-Lubrite rust-resistant, oil-retaining finish;
- fast operate and release time.

You can order XY Deca Switches in a wide variety of off normal and release magnet spring combinations to suit your specific requirements. Compact and light, the switches are 4¾" long, 4" wide, 1½" high and weigh 20¼ ounces.

Complete technical details are contained in Bulletin T-5001, available on request.



STROMBERG-CARLSON

A DIVISION OF GENERAL DYNAMICS CORPORATION
TELECOMMUNICATION INDUSTRIAL SALES
1 CARLSON ROAD, ROCHESTER 3, N. Y.

Circle 296 Readers Service Card

Rectified RELAYS advance Reliability

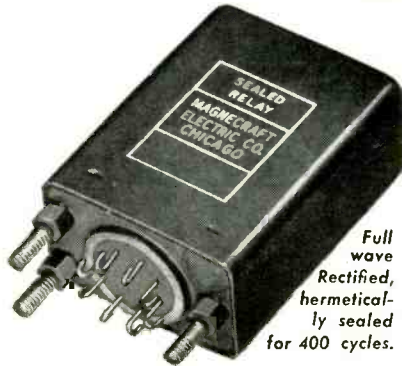

Full wave Rectified, hermetically sealed for 400 cycles.

Improvements, over conventionally operated AC relays, afforded through all frequencies from 25 to 400 cycles by MAGNECRAFT full-wave rectified relays, include—

- Increased operating sensitivity
- Higher contact pressures
- Greater resistance to vibration
- Operation through much wider variation in voltage or current
- Quiet operation, free of AC hum
- Smaller size

MAGNECRAFT full-wave rectification adds nothing to mounting and wiring problems.

Tell us what you need or send for catalog.

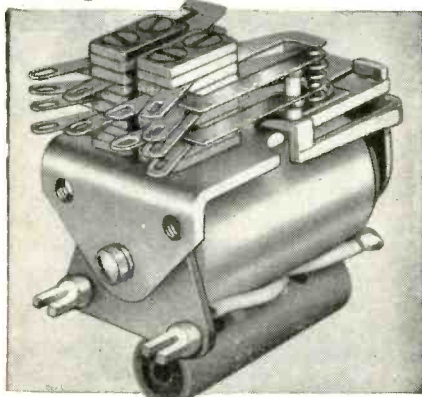

Full wave rectified for 60 cycles. Contact combinations to 6PDT

MAGNECRAFT Electric Company

3350B W. Grand, Chicago 51, Ill.

Circle 297 Readers Service Card

PLANTS AND PEOPLE

(continued)



Clifford A. Busse

the E. F. Johnson Co. of Waseca, Minn., where he directed the design and development of transmitting components, high power r-f components, induction heating equipment and antenna systems.

Jobbins Adds to Its Facilities

JOBbins ELECTRONIC ENTERPRISES, Menlo Park, Calif., has recently announced an addition to its present facilities. The expansion will more than double its existing floor space and will alleviate a working space problem created by the organization's rapid growth.

The company has been manufacturing transformers, chokes, current and voltage regulated power supplies, coils, solenoids and electromagnets. The new addition allows it to expand its production capabilities.

USNOL Names Husten Fuze Dept. Head

ANNOUNCEMENT has been made of the appointment of Benjamin F. Husten as Head of the Fuze Department of the U. S. Naval Ordnance Laboratory, Corona. A government employee since 1938, Husten spent many years with the National Bureau of Standards, where he worked on the design of electronic devices for combustion research. Later, while engaged in research and development on mi-

SINCE 1917



We've been meeting the need for precision manufacturing facilities

... and, we can do

it for you, too.

Boehme practical experience in the design and manufacture of mechanical, electrical and electronic products for automation and instrumentation can solve your most exacting demands. Learn more about Boehme's prompt, efficient, economical service and how readily it applies to your needs.

Send for your copy of The Boehme Brochure, now! There is no obligation, of course.



H. O. Boehme, Inc.

Designers and Manufacturers

Communication Equipment

Precision Electro-Mechanical

Apparatus Since 1917

915 Broadway

New York 10, N. Y.



Circle 298 Readers Service Card

November 1, 1957 — ELECTRONICS

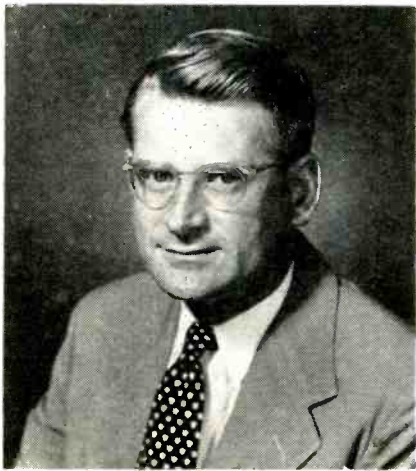

Benjamin F. Husten

crowave frequency standards, he worked on the development of the first atomic clock and shares credit for its invention.

Husten has been at the Corona laboratory since 1951, working in both missile guidance and fuze development. In his new position, he will be responsible for guided missile fuze research, development, test, evaluation, and safety certification, as well as technical direction and contract administration for the Navy guided missile fuze research and development program.

Relay Company Formed

A NEW company, Reltron Corp., has recently been organized in Newton, Mass., to manufacture high-temperature subminiature relays. The company's relays are reliably operable to 250 C.

Meridian Metalcraft Sets Up New Section

C. W. PETERSON, President of Meridian Metalcraft, Inc., Whittier, Calif., has announced that the waveguide component manufacturing company recently set up a new and separate production test section. This has become necessary because of an increasing level of production test activity on commercial and military lightweight magnesium microwave devices.

Heretofore, production test work has been a part of the engineering department, responsible for both

MEASUREMENTS' UHF Standard SIGNAL GENERATOR

400-1000 Mc



Model 84-TRV

FEATURES

- Accurately calibrated mutual-inductance type attenuator.
- 50-ohm source impedance with VSWR of 1.2.
- Direct indication of per cent modulation.
- Negligible stray field and leakage.
- Low residual AM and FM.

CONDENSED SPECIFICATIONS

Frequency Range: 400 Mc to 1000 Mc in one band.

Frequency Accuracy: Individually calibrated to $\pm 0.5\%$ accuracy.

Output Voltage: Continuously variable from 0.1 microvolt to 0.5 volt.

Output Accuracy: $\pm 10\%$ from 400 Mc to 750 Mc and $\pm 20\%$ from 750 Mc to 1000 Mc.

Amplitude Modulation: 0-30% modulation from internal 1000-cycle oscillator, or from 50 to 20,000-cycle external source.

Power Supply: 117 volts, 50-60 cycles, 60 watts.

USES

Aligning and tracking of UHF receivers including sensitivity, signal-to-noise ratio, conversion gain, selectivity, overload, automatic gain control, image and intermediate frequency rejection ratios, quieting and stage gain.

Driving source for slotted lines, for R-F bridges, and other impedance measuring devices.

Standing wave measurements on transmission lines.

Measuring antenna patterns and gain.

Testing and alignment of Citizen's Band, UHF television, FM, and Mobile communication equipment.

WRITE FOR BULLETIN

Laboratory Standards



MEASUREMENTS CORPORATION

BOONTON, NEW JERSEY

Circle 299 Readers Service Card

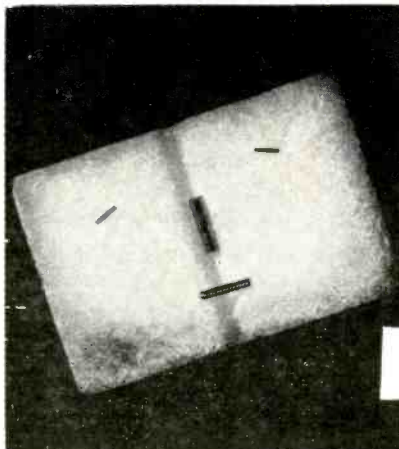

WORRIED ABOUT PRECISION PIVOTS?

Call WK

Steel, chromium plated, or carbide precision pivots to .013" diameter. 1 RMS or finer surface finish. Diameter tolerances to .000010". Chamfers, radii, lapped ends, etc.

Also volume production lapping of flat or round production parts.

Submit your specifications

THE VAN KEUREN COMPANY
176-D WALTHAM STREET
WATERTOWN, MASS.

The photographer's nightmare at the left consists of a lump of sugar and four VK Precision Parts. The "eyes" are .080" long.

Circle 300 Readers Service Card

Electrical Coil Windings

For 40 years . . . specializing in all types of coils to customers' specifications. Design or engineering assistance available on request.

COTO-COIL CO., INC.

SINCE 1917

65 Pavilion Avenue Providence 5, Rhode Island

R & D microwave work and production testing.

The current shift of production test function responsibilities, creating the new section under the quality Control Department, is part of a plant-wide reorganization and overall expansion.

Hahn Moves To Sales



Richard Hahn

APPOINTMENT of Richard Hahn as assistant sales manager—components, of The Victoreen Instrument Co. has been announced.

Hahn was previously associated with the Clevite Center of the Clevite Corp., Cleveland, Ohio, as an electronics engineer. Prior to this, he was a member of the research staff at Case Institute of Technology serving in government research on USAF projects.

West Coast Firm Builds \$1 Million Plant

TEKTRONIX, INC., Portland, Ore., manufacturer of cathode-ray oscilloscopes, is building a new \$1 million plant in a major expansion move.

Some operations will be moved from the firm's present plant near Beaverton, Ore., but both plants will continue to be operated, according to William Webber, vice-president.

The new plant is to be a modular-type structure of five units of 21,-



**THE REACH IS RIGHT
AND TIGHT
with KRAEUTER
LONG NOSE PLIERS**

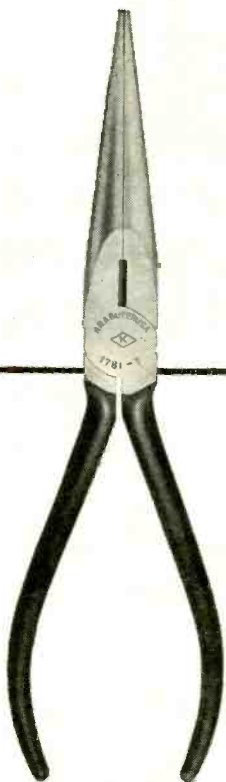

#1781-7"

You can depend on reachability and cutting power with Krauter's #1781 Long Chain Nose Pliers. And your reach will be tight and sure for those hard-to-get-at jobs with the extra long milled jaws of these pliers.

Buy the right line. It's the Krauter line for electronic and electrical work. Krauter tools are unreservedly guaranteed.

Send for catalog #25 illustrating complete Krauter line.

**BUY THE FINEST
BUY KRAEUTER
BUY AMERICAN**

AS MODERN AS TOMORROW

krauter & co., inc

FOR 100 YEARS THE FINEST IN HAND TOOLS 1850-1950 NEWARK, N. J.
Circle 302 Readers Service Card



electronics BUYERS' GUIDE REVISIONS

1957-1958 Issue

CORRECTIONS:

Revised and corrected company listings under GLASS BONDED MICA. Use this list for sources in obtaining GLASS BONDED MICA.

ALLIED PLASTICS SUPPLY CORP., 75 Cliff St., New York 38, N. Y. ADV. PG. 247.

ELECTRONIC MECHANICS, INC., 101 Clifton Blvd., Clifton, N. J. ADV. PG. 508.

General Electric Co., Plastics Dept., Taunton, Mass.

Minerals & Insulation Co., 53 Central Ave., Rochelle Park, N. J.

MYCALEX CORPORATION OF AMERICA, 125 Clifton Blvd., Clifton, N. J. ADV. PG. 140, 141.

RELIANCE MICA CO., 341 39th St., Brooklyn, N. Y. ADV. PG. 695.

DYNAMOTORS

Advertising Page number for CONTINENTAL ELECTRIC CO., INC., 334 Ferry St., Newark 5, N. J. should be 557.

ADDITIONS:

COMMUNICATION SYSTEMS

- 3. Carrier Current
- 7. Microwave

Lenkurt Electric Co., Inc., 1105 County Rd., San Carlos, Calif.

PLATES, NAME—Metal or Plastic

CANADIAN RADIUM & URANIUM CORP., 630 Fifth Ave., New York 20, N. Y. ADV. PG. 665.

REGISTERS—Shift

EPSCO, INCORPORATED, 588 Commonwealth Ave., Boston 15, Mass. ADV. PG. 233-235.

SHUNTS—Meter

Ram Meter, Inc., 1100 Hilton Rd., Ferndale, Detroit 20, Mich.

WIRE—Teflon Insulated

TENSOLITE INSULATED WIRE CO., INC., 190 Main St., Tarrytown, N. Y. ADV. PG. 261-264.

DELETIONS:

CONTACTORS

FARMER ELECTRIC PRODUCTS CO., INC., 2300 Washington St., Newton Lower Falls 62, Mass. ADV. PG. 546.

FERRITES

COLUMBIAN CARBON CO., MAPICO COLOR UNIT, 380 Madison Ave., New York 17, N. Y. ADV. PG. 667.

How To Get Things Done Better And Faster

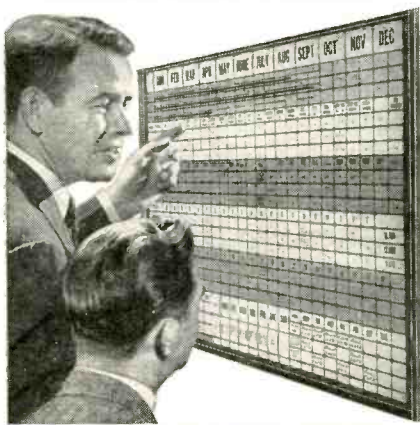

BOARDMASTER VISUAL CONTROL

- ☆ Gives Graphic Picture—Saves Time, Saves Money, Prevents Errors
- ☆ Simple to operate—Type or Write on Cards, Snap in Grooves
- ☆ Ideal for Production, Traffic, Inventory, Scheduling, Sales, Etc.
- ☆ Made of Metal Compact and Attractive. Over 200,000 in Use.

Full price **\$4950** with cards

FREE 24-PAGE BOOKLET NO. C-40
Without Obligation

Write for Your Copy Today

GRAPHIC SYSTEMS

55 West 42nd Street • New York 36, N. Y.
Circle 303 Readers Service Card

NORTH HILL'S MODEL CG-1



Constant Current 1 ma to 30 amps

- ▶ Rapid manual or automatic switching to desired current levels.
- ▶ High accuracy and stability.
- ▶ Current can be electronically switched, pulsed, swept, modulated and programmed.

Ideal for Rapid Testing of:

- ▶ Semiconductors
- ▶ Electromagnetic Components
- ▶ Other Current-Sensitive Devices

- Model CG-1 1 ma — 600 ma
- Model CG-11 Transistorized .05 — 5 amps
- Model CG-12 Transistorized .5 — 30 amps

For further data,
write for Bulletin E-1M

nh

NORTH HILLS ELECTRIC CO., INC.
402 Sagamore Ave., Mineola, N. Y., PI 7-0555

Circle 304 Readers Service Card

ELECTRONICS — November 1, 1957

PLANTS AND PEOPLE

(continued)

000 sq ft each. They are rising in a 300-acre industrial park being developed by the Tektronix Employees Retirement fund. The firm recently completed a 32,000 sq ft warehouse in the park.

Volkert Forms Division in Pa.

FORMATION of a division, to be known as Vidmar, Inc., to produce drawer-type metal storage cabinets for industry, has been announced by Volkert Stampings, Inc., Queens Village, N. Y., manufacturer of precision metal stampings for the electronics industry.

Vidmar will occupy a new 44,000 sq ft plant in Williamsport, Pa., next year. The building is expected to be completed by March 1958, with production operations scheduled to begin two months later.

The Queens Village stampings operation will continue without change under its present management.

Burroughs Names Baird

APPOINTMENT of George A. Baird to the new post of associate director of engineering, responsible for engineering coordination of all commercial products manufactured by Burroughs Corp., has been announced.

Baird joined Burroughs in 1949



George A. Baird

DELIVER

YOUR
PROJECT
ON TIME



with
EECO

COMPUTER-SERIES PLUG-INS

Originally developed for EECO custom systems and proven in critical use, new EECO Computer-Series Plug-ins represent a refinement of the building-block concept to a degree hitherto unknown. Each of the full line of reliable, tested, and proven circuits is a complete off-the-shelf packaged function, performance-engineered for application where ultra-conservative design at the component level is essential because of system complexity.

New EECO Computer-Series Plug-ins enable you to meet your project delivery schedules by reducing systems-development time to a bare minimum and practically eliminating drafting and layout time. Your engineers can concentrate on system design instead of routine circuit detail. Your technicians can cut fabrication time and step up production by performing simple point-to-point wiring instead of wiring complex circuits. And system prototypes can generally be built directly without need for the "breadboard" stage.

Detailed information on
Computer-Series Plug-ins,
Standard-Series Plug-ins,
Systems Development Racks,
Power Supplies,
D-C Amplifiers
...and other EECO products
is available in
Catalog No. 856-A.
Write for your copy—today.

ENGINEERED ELECTRONICS COMPANY
(formerly EECO Production Company)

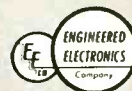

a subsidiary of
Electronic Engineering Company
of California

506 EAST FIRST STREET
SANTA ANA, CALIFORNIA

Circle 305 Readers Service Card

Rectifier Recorders by ESTERLINE-ANGUS

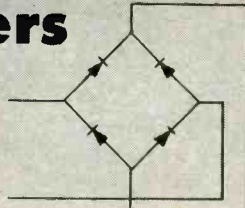

**Multi-Range, Multi-Purpose AC-DC Ammeter/
Voltmeter**

Several AC and DC ranges can be combined in one instrument. All ranges have uniform scales.

AC

0-50 MA, 0-1 to 0-10 Amperes.
0-50 to 0-800 Volts (20 ohms/volt)

DC

0-100 to 0-750 Millivolts
0-1 to 0-800 Volts (Approx. 24 ohms/volt)

One popular combination includes these ranges:

0-50 MA, 0-5/10 A AC } 25-800 cycles
0-150/300/600 V AC }
0-150/300/600 V DC }

Ask for Catalog Section 48

Product Representatives in Most Principal Cities

The ESTERLINE-ANGUS Company, Inc.

Pioneers in the Manufacture of Graphic Instruments

DEPT. E 7, P. O. BOX 596, INDIANAPOLIS 6, INDIANA



Circle 306 Readers Service Card

Linearity

better
than
0.0025%



WITH
ESI
MODEL
RV-622

**DEKAVIDER®
decade voltage divider**

specifications

INPUT RESISTANCE: 10,000 ohms
LINEARITY: $\pm 0.0025\%$
RESOLUTION: 0.0001%
MOUNTING: 19" x 3 1/2" panel for standard relay rack.
PRICE: \$395.00

For complete information, contact your nearest ESI representative or...

A precision Kelvin-Varley voltage divider for rack mounting, employing six decades of resistors, closely matched for highest accuracy. Linearity specification applies from d.c. to approximately 1 kc. Phase shift is about one degree at 10 kc.

ELECTRO-MEASUREMENTS, INC.

7524 S. W. MACADAM AVENUE
PORTLAND 1, OREGON



Circle 307 Readers Service Card

at its Paoli, Pa., Research Center as a research associate. He became a project engineer in 1952 and was appointed manager of the Center's electromechanisms department in 1955, the post he held prior to his latest appointment.

Before joining Burroughs, Baird was a research assistant at the University of Pa., and a test engineer with GE Co.

Arizona U. Appoints EE Prof

THE University of Arizona, Tucson, Arizona, has announced the appointment of Granino A. Korn as a professor of electrical engineering. Dr. Korn was previously active as a staff engineer, Military Operations Research Division, Lockheed Aircraft Corp., and as a consultant under his own name. He is co-author of "Electronic Analog Computers" and of a number of articles in engineering handbooks.

IRC Announces Recent Appointments

INTERNATIONAL RESISTANCE Co., Philadelphia, announces the recent appointment of Henry Schumer to chief engineer of its Asheville, N. C. plant. James Wilkes has been appointed manager, quality control, of the Philadelphia plant.

Schumer joined IRC in 1953 and



Henry Schumer

quality ...
uniformity ...
service ...

GLASS for
HERMETIC SEALING
• EPOXY PREFORMS
• PRESSED
CERAMICS

mansol
CERAMICS CO.

138 LITTLE ST. THORNTON HEATH
BELLEVILLE, NEW JERSEY SURREY, ENGLAND

Circle 308 Readers Service Card



James Wilkes

has since held several positions within the quality control department, most recent being manager, quality control. Previously he had been associated with the Sonotone Corp.

Wilkes, who joined IRC in 1950, has also had considerable experience in the field of quality control. Prior to joining IRC, he was associated with Dumont Television.

Smith Enters Factory Rep Field

MYRON R. SMITH, recently resigned from his position as staff engineer with the Seattle Development Laboratory of Minneapolis-Honeywell Regulator Co., after 13 years in various engineering positions in Minneapolis and Seattle. Previously he was with the Collins Radio Co. of Cedar Rapids, Iowa, for nine years.

Smith has now opened an office to serve the Pacific Northwest as a factory representative. He is located at 4524 Roosevelt Way, Seattle 5, Wash.

Knopp Inc. Moves Into New Building

KNOPP INC., of Oakland, Calif., has moved into a new factory with four times the productive capacity. It has been announced by Harold P. Knopp, President. The new loca-

TRANSISTOR INVERTER

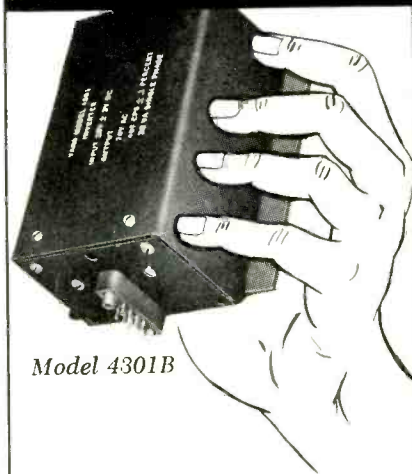

Model 4301B

• 30 VA OUTPUT

MISSILES AND AIRCRAFT

The Model 4301B is a typical Varo transistor inverter. Other models with higher power output, higher frequency output, and ac input are available for systems engineering. Custom designs can be produced for special applications.

SPECIFICATIONS

Output: 30 V.A. 1 Φ
Frequency: 400 cps \pm 0.1%
Voltage: 115 V \pm 10%
Harmonics: 10% max.
Input: 26 to 29 VDC
Temperature: -55°F to +160°F
Vibration: 10g to 1000 cps
Size: 29 cu. in.
Weight: 2 lb.

Varo transistor inverters are designed to operate gyros in guidance systems. They are frequency regulated by a Varo bimetal tuning fork, voltage regulated by a zener diode reference, and produce a sine wave output through Class B amplification.

Attractive Research Positions Available

VARO Mfg. Co., Inc.

2201 Walnut St., Garland, Texas

PHONE DALLAS, TEXAS — Broadway 6-6141

FACTORY REPRESENTATIVES

LOS ANGELES, CALIFORNIA — Republic 4-0154
POUGHKEEPSIE, N.Y. — Globe 4-7611
DAYTON, OHIO — Clearwater 4-5281

Circle 310 Readers Service Card

ZOPHAR

—WAXES
—COMPOUNDS

Zophar Waxes, resins and compounds to impregnate, dip, seal, embed, or pot electronic and electrical equipment or components of all types; radio, television, etc. Cold flows from 100°F. to 285°F. Special waxes non-cracking at -76°F. plain or fungicidal. Let us help you with your engineering problems.

For immediate service contact:

L. E. Mayer, Sales Manager
A. Saunders, Technical Director
H. Saunders, Chemical Laboratory
Phone 50uth 8-0907



ZOPHAR MILLS, INC.
112-130 26th Street,
Brooklyn 32, N. Y.

Circle 309 Readers Service Card

ELECTRONICS — November 1, 1957

Transistor Electronics

JUST PUBLISHED! Brings you a profitable working knowledge of quantitative transistor circuit design, based on a clear-cut understanding of the internal workings of the transistor device. Assures useful design accuracy without requiring prior knowledge of quantum mechanics. Practical, down-to-earth, and easy to read, the book stresses specific prototype circuit uses. By David DeWitt, IBM Data Proc. Div., and Arthur L. Rossoff, Radio Receptor Co. 381 pp., illus., \$8.00

Handbook of Noise Control

JUST PUBLISHED! A comprehensive handbook on the subject of noise, its nature, its measurement, and techniques of its control in buildings, industry, transportation, and the community. Shows how noise effects man in efficiency, hearing, and speech communication; discusses vibration and its control; control of industrial, aircraft, automobile, and rail transportation noise. Edited by Cyril M. Harris, Acoustics Lab., Columbia U. 1184 pp., 700 illus., \$16.50

Selection and Application of Metallic Rectifiers

JUST PUBLISHED! Provides quick, reliable answers to all necessary data on circuit problems—and the essential filters, transformers—and a clear mathematical tools to deal with circuit design. By developing together a clear idea of circuits and cell characteristics, the book shows design procedures for such uses as pulse circuits, industrial and electroplating power supplies, etc. By Stuart P. Jackson, GE Co. 326 pp., 216 illus., \$8.00

Television Engineering Handbook

Covers the entire subject of television technology, including fundamentals as well as practical design data for transmitters, receivers, and networks. Besides a full treatment of color television, there are sections on colorimetry, video waveforms, design of wideband amplifiers, and of deflection systems. Edited by Donald G. Fink, Philco Corp., 1483 pp., 1159 illus., \$18.00

SEE ANY BOOK 10 DAYS FREE

McGraw-Hill Book Co., Dept. L-11
327 W. 41st St., N. Y. 36, N. Y.

Send me book(s) checked below for 10 days' examination on approval. In 10 days I will remit for book(s) I keep, plus few cents for delivery costs, and return unwanted book(s) postpaid. We pay delivery costs if you remit with this coupon—same return privilege.

- DeWitt & Rossoff—Trans. Elect., \$8.00
 Harris—Hdbk. of Noise Control, \$16.50
 Jackson—Sel., Applic. of Met. Rect., \$8.00
 Fink—Television Engrg. Hdbk., \$18.00

(PRINT)

Name

Address

City Zone State

Company

Position

For price and terms outside U. S. write McGraw-Hill Int'l. N. Y. C. L-11

tion is 1307 66th St., Oakland 8, Calif.

Founded almost 30 years ago by the late Otto A. Knopp, inventor, Knopp Inc. are manufacturers of high-precision electrical-testing devices and laboratory apparatus.

Hadrick Joins Simpson



Frank Hadrick

SIMPSON ELECTRIC Co., Chicago, Ill., has added Frank Hadrick to its engineering staff as chief field engineer (test equipment). Formerly chief tv field engineer for Admiral Corp., he was instrumental in developing their color tv training program.

In his new position, he will play an integral part in the design and development of the company's test equipment and will be available for consultation concerning tv and other electronic testing problems.

Core Measurements Man Joins G-L Electronics

JAMES R. JAQUET, an authority in the field of tape wound core measurements, recently joined the engineering staff of G-L Electronics, 2921 Admiral Wilson Blvd., Camden, N. J. In this new post he will be responsible for the company's measurement program on tape wound cores and bobbin cores.

Jaquet spent several years with Westinghouse Electric, where he



This Man Has E.Q. DO YOU?

Trevor Clark is Assistant to the Engineering Manager of the Westinghouse-Baltimore Air Arm Operation. His E.Q. (Exceptional Qualifications) make him a valued member of the engineering staff. He has an A.B. in Physics and Mathematics, an M.S. in Physics and further graduate work in Physics, Mathematics and Engineering. His background includes 28 years experience in research, development, manufacturing, sales and management in the fields of avionics; microwave systems and components; radio and radar; nationally and internationally. Mr. Clark has 30 issued patents and 10 patent applications pending.

Engineers like Trevor Clark—men with Exceptional Qualifications—are the backbone of Westinghouse-Baltimore's continued leadership in the electronics field.

WILL YOUR E. Q. MEASURE UP? Could you fill one of the specialized openings now available at Westinghouse-Baltimore? Why not drop us a letter and find out. WRITE TO: Dr. J. A. Medwin, Westinghouse Electric Corporation, Dept. 725, P. O. Box 746, Baltimore 3, Maryland.

Westinghouse
BALTIMORE



SINCE 1886

Advanced Electronics Systems, Ordnance, X-Ray, Carrier Microwave, and Induction Heating Equipment for Military, Industrial, and Commercial Purposes

An Engineer's Company

concentrated on tape wound core measurements and magnetic component design. He is a member of the Working Group on Core Matching and Grading of the AIEE, and of Subcommittee 8.3.1 on Methods of Measurements of Bobbin Cores of the IRE.

AMF R&D Director Named



Thomas P. Evans

THOMAS P. EVANS has been appointed director of research and development of American Machine & Foundry Co. Evans joined AMF in 1951 as chief systems engineer, electrical. In 1952 he was appointed chief electrical engineer; in 1953, section manager of AMF's General Engineering Laboratories at Greenwich, Conn., and in 1954, technical director of the Laboratories. He was made deputy director of research and development in September 1955.

Electronic Associates Opens Overseas Operation

BELGIAN Minister of Foreign Trade, Henri Fayat, and C. L. Adamson, vice-president of Electronic Associates Inc., Long Branch, N. J., recently officially opened the U. S. firm's first overseas operation, the European Computation Center in Brussels.

The Center is equipped with two expanded analog computer systems and provides education to engi-

MULTIMETER

Type MM1

8 RF RANGES:
2 to 55000 $\mu\mu\text{F}$
0.02 μH to 55 mH

15 POWER FREQ. RANGES:
0 to 1000 μF
0 to 1000 H
0 to 10 Megohms

DISSIPATION FACTOR:
0 to 0.6

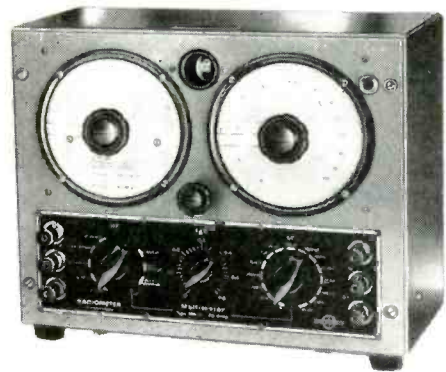

This instrument offers convenient and fast measurement of practically any component used in the electronic laboratory.

RADIOMETER

72 Emdrupvej, Copenhagen NV-2, Denmark



Represented in Canada by

BACH-SIMPSON • London/Ontario

Represented in the United States by

WELWYN INT. INC. • 3355 Edgecliff Terrace, Cleveland 11, Ohio

Circle 311 Readers Service Card



TOROIDS

Built to individual specifications both military and commercial regardless of order size. Wire sizes 18 to 42 AWG. Plain, wrapped, waxed, varnished or encapsulated.

Extensive test and production facilities include modern toroidal winding machines, machine shop, tool room, impregnation and encapsulation equipment.

Send drawings or specifications for quotation. For quality, dependability, low cost—

HALL MFG. CO.

3901 WESLEY TERRACE
SCHILLER PARK, ILL.

Branch factory: Cassville, Wisc.

Circle 312 Readers Service Card

MAGNETS

HIGH ENERGY
PRECISION
ALNICO
PERMANENT
MAGNETS

WE CARRY
IN STOCK
ALL SIZES,
ALL SHAPES,
ALL ALNICO
GRADES...

When you need them — as you need them. Experimental or production quantities.

PERMAG
services include
ENGINEERING
PRECISION CUTTING
PRECISION GRINDING
MAGNETIZING

24 HOUR DELIVERY

Send for Catalog

PERMAG CORP.
210 TAAFFE PLACE, BROOKLYN 5, N. Y.
Phone: MAin 2-0114

Precision drilling made easy!

The *Phillips & Hiss*

204-D

6" Throat
0 to 1/8" Capacity



Sensitive "Feel"

Sensitive Speed Control: Foot operated, leaves both hands free.

High Precision: Spindle true within .0002". Table square .0001" per inch. Accuracy permanent, castings annealed and ground.

Phillips & Hiss Company Inc.

1145 No. McCadden Place
Hollywood 38, California
Circle 315 Readers Service Card

neers in analog computer techniques, consultation service and rental time on the Center's machinery. It is staffed by qualified application engineers who specialize in problem analysis, programming, computer operation and solution evaluation.

The European Computation Center will be directed by Dr. Bernard Murphy, a graduate of the University of Liverpool.

Lynch Carrier Systems Promotes Garzoli

FULVIO F. GARZOLI, who for the past several years has been a project engineer with Lynch Carrier Systems Inc., San Francisco, Calif., manufacturers of telephone and telegraph carrier equipment, has recently been appointed to the position of chief design engineer. In addition to telephone equipment design, F. F. Garzoli has worked in the field of aerial camera control systems and aerial navigational equipment design.

Davis Appointed Asst. Chief Engr. for Systems

BJ ELECTRONICS, Santa Ana, Calif., has named Raymond Davis as assistant chief engineer for Systems. He will also serve as staff assistant to John R. Harkness, vice presi-



Raymond Davis

"Acton Laboratories RECORDER has . . .

12

TWELVE TIMES MORE

Recording Capacity than . . ."



for complete details, ask for LABORATORY REPORT Vol. II No. 8



ACTON LABORATORIES, INC.
ACTON, MASS.

Circle 316 Readers Service Card
November 1, 1957 — ELECTRONICS



Look no further—
If you're looking for
"HIGH PURITY"
fused quartz

LABORATORY WARE

The world's largest producer of fused quartz products can help you with your most critical and exacting needs for your laboratory ware.

Vitreosil® products can be supplied in an unusually large variety of types and sizes. Also fabricated to specification to meet semiconductor requirements for the production of silicon metal.

TRANSPARENT VITREOSIL

For ultra-violet applications, metallurgical investigations, chemical research and analysis, photochemistry, spectroscopy and physical, optical and electrical research.

Send specifications for your requirements. Please use coupon below.

THERMAL AMERICAN FUSED QUARTZ CO., INC.
18-20 Salem Street, Dover, New Jersey

Please send technical data on

Company _____

Name & Title _____

Street _____

City _____ Zone _____ State _____

Circle 314 Readers Service Card

dent and general manager, with responsibility for new product planning.

Davis joins the Borg-Warner electronic center following two years with Ramo-Wooldridge Corp., as a member of the technical staff, computer systems division.

Narda Acquires Two New Buildings

THE NARDA MICROWAVE CORP., Mineola, N. Y., has acquired two new buildings in the vicinity of the present plant at 160 Herricks Road, as a part of a general expansion program in all areas of the company's operations.

Transfer of manufacturing facilities, including electronics, assembly and production testing, into the first of the new buildings has been completed. This plant, containing approximately 6,500 sq. ft., will also house a new engineering laboratory.

Narda manufactures a complete line of coaxial and waveguide test instruments for microwave and uhf equipment.

Miller Joins Delco

DR. ROBERT FRANK MILLER, a former member of the faculty at



R. F. Miller

SILVER PAINT AND SILVER PASTE

Take the "bugs" out of the application of conductive silver coatings. Use Drakenfeld silver paint and silver paste tailored to meet your needs. We formulate special compositions for glass and ceramic bodies and other materials. Let us know your specific requirements. Samples will be supplied to fit them. Your inquiry will receive prompt attention.

B. F. DRAKENFELD & CO., INC.

Box 519, Washington, Pennsylvania

Drakenfeld

YOUR PARTNER IN SOLVING CONDUCTIVE COATING PROBLEMS

Circle 317 Readers Service Card

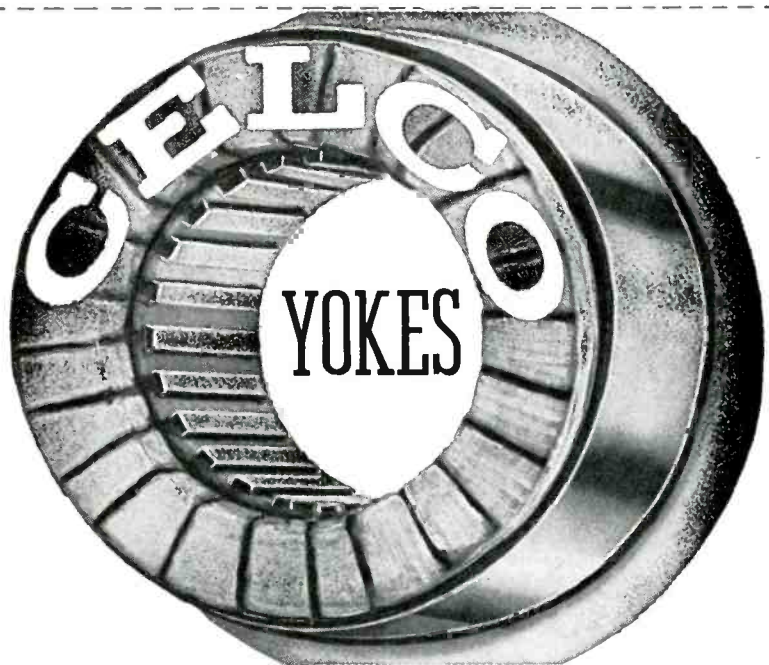

FOR HIGH ACCURACY DISPLAY SYSTEMS

We specialize in the design and manufacture of precision deflection Yokes for military and commercial applications. Phone or write for immediate engineering evaluation of your critical display problems — Phone DAVis 7-1123. MAHWAH, N. J.



Celco Constantine Engineering Laboratories Co.

MAHWAH, NEW JERSEY

CEN-TRI-CORE®

for critical electrical applications



Cen-Tri-Core consists of a solder wire coated with either an energized or plastic rosin flux over which is formed an outer sleeve. It exceeds Federal Specs. QQ-S-571b and MIL S-6872.

How 3 part construction of Alpha's CEN-TRI-CORE® solder

safely ends cold joints . . . cuts waste!

You'll find every inch of Cen-Tri-Core solder, thanks to its core within a core construction, firmly filled with a fast acting, non-conducting, non-corrosive flux, ending *once and for all* cold joints resulting from skip spots. Naturally, a perfect joint every time reduces waste substantially.

It makes good sense to specify Alpha Cen-Tri-Core. You know reliability above all is vital. Cen-Tri-Core offers that and proves it by exceeding all government specifications. Speed is essential too. A fast flowing, close-to-the-surface flux is the answer and Cen-Tri-Core has it.

WANT MORE FACTS? WRITE DEPT. CU TODAY.



OTHER ALPHA PRODUCTS

Wide Range of Fluxes

High Purity Metals . . . Soft Solder Preforms

IN CHICAGO, ILLINOIS

(Division of Alpha Metals)

Circle 319 Readers Service Card

the U. of Wisconsin electrical engineering school, has joined the Delco Radio Division at Kokomo, Ind., as a research engineer in the Semiconductor Research and Engineering Dept.

Ranger Receives SMPTE Warner Award

COL. RICHARD H. RANGER, president of Rangertone, Inc., Newark, N. J., was recently chosen by the SMPTE to receive its Samuel L. Warner Memorial Award. Presentation of the award was made October 4 at the Sheraton Hotel, Philadelphia, during the Society's 82nd Convention.

Specifically, Ranger was selected "for the invention, development and application of a method of electronically synchronizing sound recorded on magnetic tape to the motion picture camera."

Data Processing Co. Organization Announced

A GROUP of the country's leading scientists and engineers, responsible for many of the outstanding electronic computer developments in industry and defense, have formed the Auerbach Electronics Corp., with headquarters in Narberth, Pa., a suburb of Philadelphia.

Heading the firm is Isaac L. Auerbach, until recently Director of the Special Products Division of the Burroughs Corp., a leader in electronic research and development.

The company will specialize in



Isaac L. Auerbach

the application of data processing techniques in the fields of automation, industrial process control, telemetering, automatic test equipment, digital communications, and numerical machine tool control.

Weinschel Engineering Appoints Chief Engineer

ALBERT L. HEDRICH has been appointed chief engineer of Weinschel Engineering, Kensington, Md.

Hedrich joined this company in July 1957 after having been with the Diamond Ordnance Fuze Laboratories of the National Bureau of Standards, as a Section Chief, for the past 8 years. Prior to his association with the National Bureau of Standards he was with the Naval Ordnance Laboratory and Naval Research Laboratory.

Sperry Rand Elects Director

C. G. HOLSCHUH, president and general manager of the Sperry Gyroscope Co. Div. of Sperry Rand Corp., was recently elected a director of the corporation at a meeting of the board of directors.

Holschuh began work at Sperry Gyroscope in 1933 and was promoted to various positions in engineering and production. He became executive vice-president and general manager of Sperry Gyroscope Co. Div., in 1955, and president and general manager in 1957.

Kaiser Builds in Phoenix

KAISER Aircraft & Electronics has located an aircraft components facility at Phoenix, Ariz., and will build a one-story, 5,000 sq-ft unit which will have an initial workforce of 50, mostly engineers and electronics technicians.

In moving a unit to Arizona, Kaiser joins a growing parade of electronics plants in the area. The new Kaiser plant will be managed by Lowell M. Shuck, former manager of the firm's Toledo electronics division.

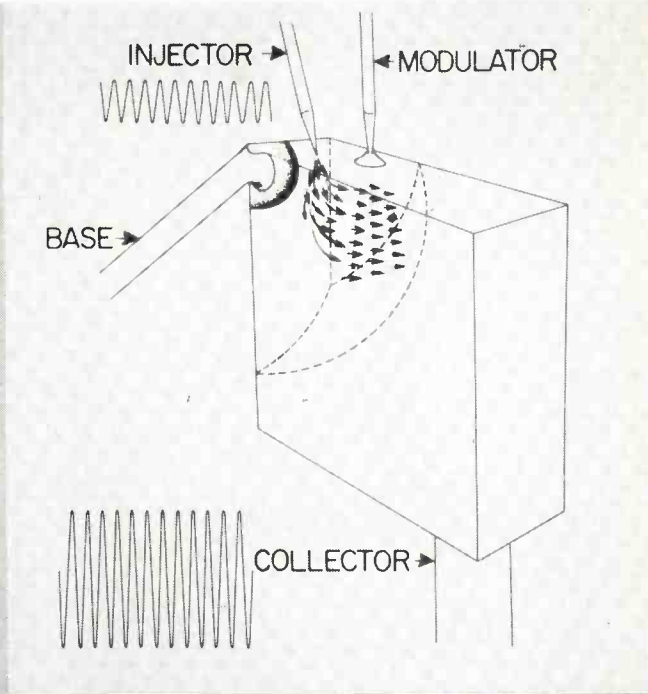
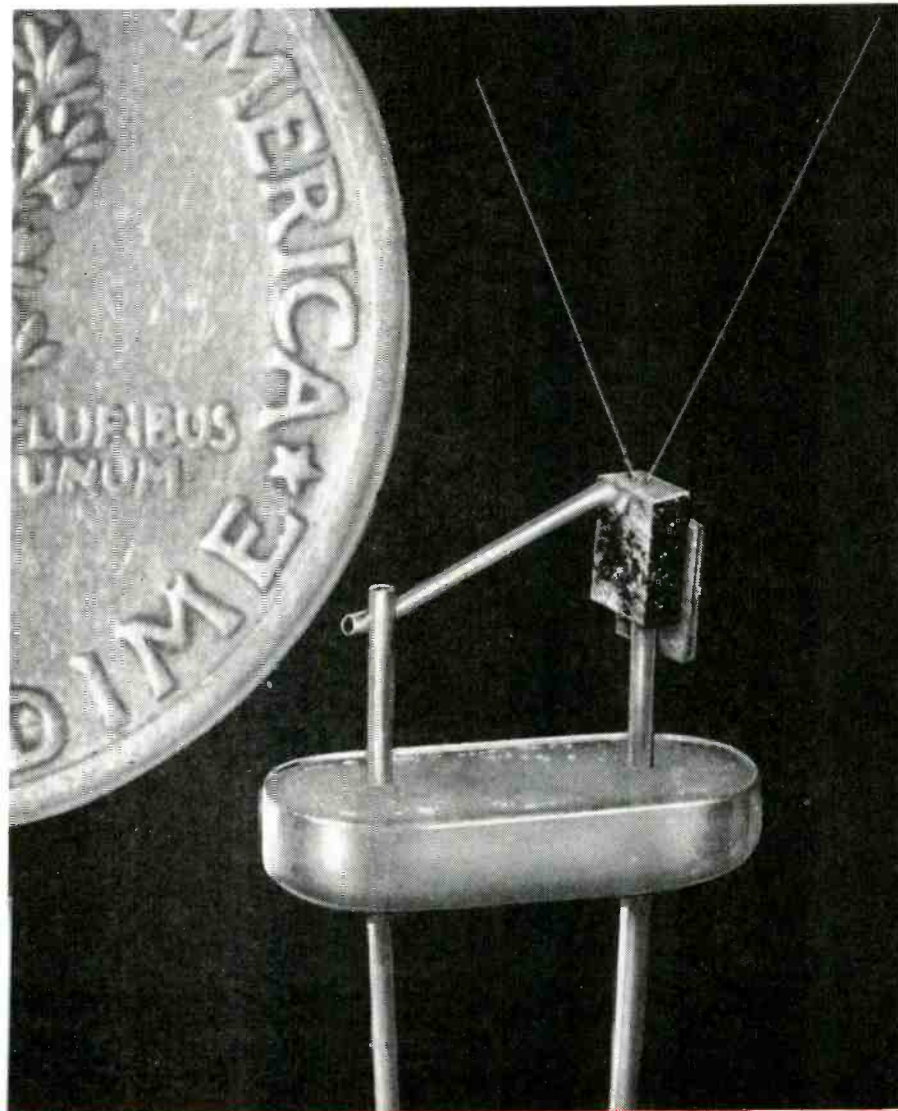

THE SPACISTOR. In July 1957, Raytheon scientists announced the "spacistor", a new semiconductor device that combines the advantages of the vacuum tube with those of the transistor. In the diagram above, voltage is applied between the "base" and "collector" so as to produce a high field and virtually no current. As voltage is applied at the "injector", electrons flow rapidly to the collector contact. The injector current is modulated by applying to the "modulator" a small signal which, since it draws negligible current, is amplified.

Are you the **ONE MAN IN THREE who will become a Raytheon engineer?**



Excellence in Electronics

As a well qualified engineer or scientist who enjoys working on new electronic developments in small, versatile project groups — you may be that man. At Raytheon, you're assured individual recognition with the challenge of responsibility and ready opportunity for advancement. For more details, see the following pages.

RAYTHEON AREAS OPEN TO YOU include missiles, radar, sonar, communications, semiconductors, microwave tubes and electron tubes. For full information, please write to E. H. Herlin at the address below or directly to the division of your choice as listed on the following pages.

RAYTHEON MANUFACTURING COMPANY
Waltham 54, Massachusetts

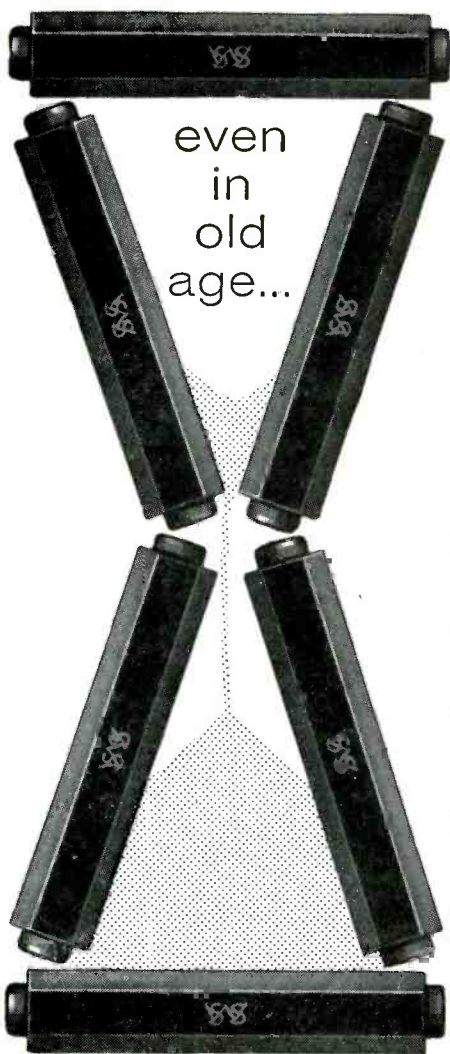

even
in
old
age...

S.S. White

MOLDED RESISTORS retain their values!

S. S. WHITE Molded Resistors retain their original values and never deteriorate due to age!

S. S. WHITE resistors serve dependably in hundreds of commercial . . . industrial . . . and scientific applications. They are characterized by low noise level . . . precision . . . stability . . . negative temperature and voltage coefficients. Non-hydroscopic base withstands temperature and humidity. They are compact, have excellent stability and mechanical strength.

For full details, write for our Bulletin 5409. We'll be glad to help you apply these high-quality, "all-weather" resistors to your product. Just drop us a line.

FIXED RESISTANCE VALUES
RANGE FROM 1000 OHMS TO
10,000,000 MEGOHMS!

65X Molded Resistor 1 watt
80X Molded Resistor 3 watts

S.S. White

S. S. WHITE INDUSTRIAL DIVISION
10 East 40th Street, New York 16, New York

Western Office: Dept. R
1839 West Pico Blvd., Los Angeles 6, Calif.

Circle 320 Readers Service Card

New Books

Proceedings of the Third International Congress on High-Speed Photography

EDITED BY R. B. COLLINS
Academic Press Inc., New York, 1957,
416 p, \$13.00.

THIS book is a collection of papers presented at the congress held under the auspices of the Department of Scientific and Industrial Research in London in 1956. The congress is the third of a series of international meetings which originated in Washington in 1952. The papers were carefully screened by a distinguished editorial panel and only reports of new work not previously published were accepted.

Speakers at the various sessions represented official and industrial agencies from such countries as England, France, Germany, Sweden, Holland, Switzerland, the United States and Japan.

► **Topics**—There were 15 sessions, each dealing with a group of similar topics: flash light sources, image-splitting and image-sampling techniques, inertialess shutters, application of high-speed photography to biology and medicine and to machine analysis, application to ballistics and explosives, instrument aids, photographic materials, X-Rays, film evaluation, Schlieren and interferometric techniques, rotating mirror cameras, medium repetition rate cameras, application to aerodynamics and application to hydrodynamics.

Of the many papers appearing in this volume, a large number make little direct use of electronics. Where electronics is used, the text often merely mentions the fact. In other instances, incomplete block diagrams and circuit diagrams are given.

Mention is made below of a few of the papers which deal more directly with electronic circuits.

► **Shaped Light**—D. P. C. Thackeray's "Emission Control of Electric Discharge" (p 21) discusses the production of shaped light

flashes which can be synchronized with a delay of only a few microseconds and provide steady level of light for a whole series of fast photographs. The illumination generated by the flash lamps is a function of time and the resistance of the discharge networks. Two pulse-forming networks are given. An added capacitor improves the rise time of the light generated by the flash lamps and a diode is used to improve the trailing edges.

H. E. Edgerton's "Small Xenon Flash Tube" (p 51) describes the development of a new small repetitive flash source which can have a multitude of applications. A schematic diagram is given of the circuit of a stroboscope in which this tube is used, as well as a table of typical performance data.

► **Spark Light**—J. S. T. Looms' and R. J. North's "Short-Duration Spark Light Sources for Photography of High-Speed Airflow" (p 62) states the electrical principles involved in the production of flashes from sparks. The inductance of the circuit and the nature of the dielectric in the capacitor principally determine the variations of light intensity with time of duration of the spark. Some properties of constructed gaps are stated. Two sources which yield flashes suitable for Schlieren photography in the wind tunnel are described and details of their construction given.

► **Ballistic Range Instrumentation**—P. Devaux' "Flash Generators with Built-In Chronometry" (p 67) shows the improvement of precision of measurement had in spark generators. Several electronic circuits are given for control of the operation of flash light sources, applying them to instrumentation of a ballistic range: (1) a basic discharge and control circuit; (2) a pulse-shaping circuit; (3) an

electronic switch circuit and (4) a pulse distributor. These basic circuits are combined with several others, not detailed, in a ballistic range setup of which the most outstanding characteristic is that the equipment measures the velocity of the missile under test and automatically determines the flash rate of the flash lamps which furnish illumination for the multiple flash photography.

P. Fayette's "Chronograph for Delay-Line Multiple-Flash, High-Speed Camera" (p 190) makes use of a cathode-ray tube as a light source. Type 2D21 thyratrons trigger one another in tandem through R-C time-delay networks. A multiplier photocell with an amplifier stage of 200-kc to 10-mc passband converts light flashes into electric pulses. The small, brilliant spot on the face of a flying-spot cathode ray tube is used to advantage as a light source.

W. Baur's and K. Pfister's "A Quartz Generator for Time-Base Recording" (p 201) gives an excellent description of the pertinent details of a 1,000-cps crystal oscillator and the characteristics which make it of use as a time base in a movie camera.

A. E. Huston's "Magnetically Suspended High-Speed Rotors" (p 294) presents a unique oscillator circuit. Two potentiometers control standing current, vertical displacement and vertical velocity of the rotor.

In "A Five-Lens High-Speed Camera System of High Resolution" by B. W. Alwood, et al., (p 337), thyratrons, R-C delay circuits and relays are combined in circuits which control shutters and electronic flash lamps.

This book should be read by all electronics engineers, especially design engineers. It contains a wealth of information about high-speed photography and is full of ideas that can be adapted to design details. It is a valuable source of general information on high-speed photography as well as a guide line for anyone who has, or expects to have, a problem for which high-speed photography offers a solution.

The discussions at the end of each session are most enlightening



DOPPLER NAVIGATION EQUIPMENT is readied for flight testing under operational conditions. Engineers at the Maynard Laboratory hold responsibility for program from initial study phase through prototype production.

Newly formed project groups solve complex airborne radar problems

Engineers like the project-type organization at Raytheon's Maynard Laboratory. It gives them maximum diversification in their work on the most advanced radar navigational and control problems of the day.

At Maynard, you'll find projects involving many areas of aircraft navigation and guidance systems . . . doppler navigation, velocity check systems, night-fighter operations systems, flight-control systems, altimeters. There is also interesting new work on counter-measures equipment.

Career opportunities for men at all levels now exist in the following areas:

ADVANCED CIRCUIT DESIGN
ELECTRONIC PACKAGING
ANTENNA DESIGN
MICROWAVE COMPONENT DESIGN

HEAT TRANSFER ENGINEERING
SPECIFICATIONS WRITING
TECHNICAL WRITING
SYSTEMS ANALYSIS & ENGINEERING

For complete details on engineering positions in any of Maynard's project groups, please write John J. Oliver, P.O. Box 87E, Raytheon Maynard Laboratory, Maynard, Mass.

RAYTHEON MANUFACTURING COMPANY
Maynard, Massachusetts

Are you the
ONE MAN IN THREE?



MAYNARD LABORATORY

Excellence in Electronics

Continued

3-D CHASSIS KIT SIMPLIFIES BREADBOARDING!

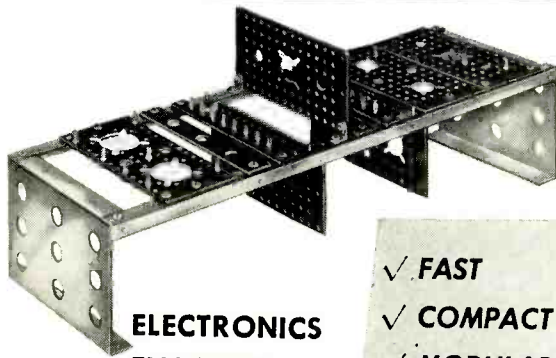

**ELECTRONICS
ENGINEERS . . .**

use the 3-D Chassis Kit in building block form in endless combinations. Receives many different type tubes . . . condensers, controls, components. Two or more may be joined. Easily wired, reusable. Simplicity, quality, low-cost! Made by specialists!

- ✓ FAST
- ✓ COMPACT
- ✓ MODULAR
- ✓ VERSATILE
- ✓ ECONOMICAL

**SEND FOR
FREE DETAILED
FOLDER**



42 Elm Street, Stoneham, Massachusetts

Circle 321 Readers Service Card

IMPREGNATING
SEALING
DIPPING
INSULATING
BLENDING



POTTING
HEAT CONDUCTING
MOISTURE PROOFING
FUNGUS PROOFING
ENCAPSULATING

WAXES BIWAX COMPOUNDS

Standard compounds available from stock.

Samples and specifications on request.

Modifications developed and produced to meet specific requirements. Information relating to your problem will enable us to make recommendations. Write to

BIWAX CORPORATION

3445 HOWARD ST.
SKOKIE ILLINOIS

Circle 322 Readers Service Card

**PRECISION
PLASTIC
CAPACITORS
AT
COMPETITIVE
PRICES!**

POLYSTYRENE and MYLAR*

Capacitance From .001 mfd to any value
Voltage From 50 V.D.C. to 30 KV
Tolerance Polystyrene From $\pm 0.1\%$ to $\pm 5\%$
Mylar* From $\pm 1\%$ to $\pm 10\%$

SMALLEST CASE SIZES

TUBULAR—BATHTUB—RECTANGULAR

Very Good Deliveries *DuPont T.M.

PRECISION CAPACITORS, INC.

150 W. Cypress Ave. Burbank, Calif.

Circle 323 Readers Service Card

and valuable as ideas are exchanged, techniques evaluated, and future trends considered.

An extensive bibliography is given and there is an excellent review of the papers presented at the Congress, as well as chapters on the Exhibition of apparatus mentioned in the papers and the Film Program held in connection with the congress.—SAMUEL DORSEY, *Ridgecrest, Calif.*

Acoustical Engineering

By HARRY F. OLSON
*D. Van Nostrand Co., Inc., N. J., 1957,
718 p, \$13.50.*

SINCE 1940 "Elements of Acoustical Engineering" by Harry F. Olson has been a valuable part of the library of those working in acoustics. Now a revised and expanded work has been published, entitled "Acoustical Engineering". This book is relatively broad in scope so that it will be found useful not only to acousticians but also to those in allied fields of engineering.

The first three chapters consider the properties of sound waves, acoustical radiating systems and mechanical radiating systems, respectively. Chapter 4 describes dynamical analogies, comparing mechanical, electrical and acoustical elements. Fundamental design information is contained in chapter 5 on acoustical elements.

► **Transducers**—Microphones and loudspeakers are treated in the next three chapters. The various types of transducers are described in detail. Cross-sectional views, analogous circuits and response curves are presented, together with formulas for pertinent parameters such as electrical impedance, efficiency, etc. Curves are shown which describe characteristics of the various types of devices, including their radiation patterns and efficiencies. Chapter 9 on miscellaneous transducers is an acoustical pot-pourri considering very briefly such widely differing subjects as the electrical megaphone, volume limiters, and sirens.

► **Measurements**—Chapter 10 cov-

ers the broad area of acoustic measurements. The methods of measuring characteristics which are described includes response frequency, directionality, nonlinear distortion, phase distortion, electrical impedance and transient response. The testing of telephone receivers and phonographs is considered, along with measurements in architectural acoustics and miscellaneous areas of acoustics.

The remaining chapters: Architectural Acoustics and the Collection and Dispersion of Sound, Speech, Music and Hearing, Complete Sound Reproducing Systems, Means for the Communication of Information, Underwater Sound and Ultrasonics, treat such widely differing subjects that it is possible only to include brief descriptions of many types of instruments, measurements and characteristics. However, because of the wide area which is covered, many readers will find this book useful as a general reference on acoustic instruments and measurements.

Dr. Olson's latest book will prove even more valuable to all students and practitioners of acoustical engineering than its predecessor.—**CYRIL M. HARRIS**, *Electronics Research Laboratories, Columbia University, New York, N. Y.*

Thumbnail Reviews

Elementary Theory of Angular Momentum. By M. E. Rose, John Wiley & Sons, Inc., New York, 1957, 248 p, \$10.00. Introduction to angular momentum based on series of lectures given at Oak Ridge National Laboratory.

The Vacuum Deposition and Properties of Thin Films. By L. Holland, John Wiley & Sons, Inc., New York, 1956, 541 p, \$10.00. Thorough review of all techniques concerned with deposition of thin films for optical, electrical and chemical purposes.

Servicing Color TV. By R. G. Middleton, Gernsback Library, Inc., New York, 1957, 224 p, \$2.90. Application of servicing techniques and instruments to color television receivers

ENGINEER OPPORTUNITIES AT RAYTHEON

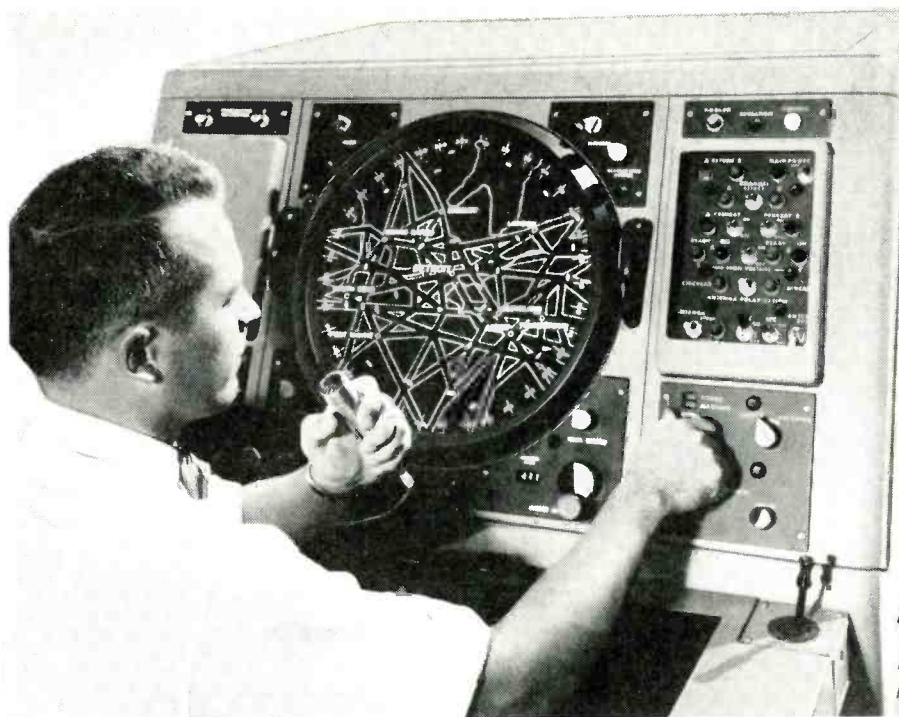

NEW C.A.A. RADAR being developed at Wayland Lab will be used in nationwide aircraft surveillance network. Features: video mapping converter, circular polarizer, complete system remote controls available at the console.

Wayland Laboratory's "dream" facilities and projects gain national reputation

Ask any development engineer who's visited Raytheon's Wayland Laboratory! He'll tell you it's one of the most modern labs for prototype development of electronic equipment and that Wayland projects are the most advanced in their respective fields.

There are four creative departments:

COMMUNICATIONS – scatter, radio relay, T.V. terminal and message circuit multiplex equipment.

COUNTERMEASURES – radar countermeasures equipment, advanced countermeasures systems and techniques study.

RADAR – pulse radar equipment including ground-based, airborne, long range search, air traffic control, weather and commercial marine.

SONAR – submarine, ship and airborne sonar equipment.

PLUS TWO OTHER DEPARTMENTS providing engineering services... *environmental test, reliability and components engineering, engineering standards, production engineering, and technical writing.*

For details, please contact Donald B. Stillman, Staff Assistant to Manager, Box 11E, Wayland Laboratory, Wayland, Mass.

RAYTHEON MANUFACTURING COMPANY
Wayland, Massachusetts

Are you the
ONE MAN IN THREE?



Excellence in Electronics

WAYLAND LABORATORY

Continued

*When speed is measured in
mach numbers the new*

WALTHAM VERTICAL GYRO

*operates faster,
more accurately*

Enables fire control systems
to "think" more clearly



The high reliability characteristics of the Waltham vertical gyro make it the logical choice of the systems manufacturer. Especially significant is the faster erection rate, for normal operational use or for a super-fast initial or in-flight erection cycle. Equally important is the longer operating life...and lower maintenance costs. Shock-resistant, vibration-resistant, hermetically sealed, this unit meets all military environmental conditions.

PERFORMANCE

VERTICAL REPEATABILITY: To within 10 minutes of arc cone.

INITIAL-ERECTION (Super-Fast): From any standing position at any temperature from -55°C to $+71^{\circ}\text{C}$ to within ± 30 minutes of arc of Vertical within 25 seconds after application of power.

IN-FLIGHT ERECTION (Super-Fast): Roll $180^{\circ}/\text{minute}$ minimum. Pitch $200^{\circ}/\text{minute}$ minimum.

NORMAL ERECTION: $5^{\circ}/\text{minute}$ $\pm 1^{\circ}/\text{minute}$.

FREE DRIFT: Roll, $0.3^{\circ}/\text{minute}$ for any Pitch angle from $+60^{\circ}$ to -60° . Pitch, $0.3^{\circ}/\text{minute}$ for any roll angle.

OPERATING LIFE: 1000 hours minimum.

SHELF LIFE: 5 years.

Send today for engineering specifications and drawings. Facilities are also available to manufacture precision mechanical and electro-mechanical assemblies to your specifications.

WALTHAM PRECISION INSTRUMENT COMPANY
FORMERLY WALTHAM WATCH COMPANY

WALTHAM 54, MASSACHUSETTS

PRECISION HAS BEEN OUR BUSINESS SINCE 1850

written for technicians. Color sync servicing, chroma circuits and matrix testing covered in detail.

European and American Receiver Tubes Interchange Simplified. By H. A. Middleton, John F. Rider, Pub., Inc., New York, 19457, 72 p, \$1.35. List of over 200 European tubes that may be replaced with American tubes and over 230 American-to-European conversions.

U. S. Research Reactors. U. S. Atomic Energy Commission, Office of Technical Services, U. S. Dept. of Commerce, Washington 25, D. C., 1957, 72 p, \$1.50. Description of more than 30 research reactors, now in operation or under construction, grouped according to major types. Examples of each type are given at length, features of others are illustrated and significant data given for all.

The Design and Conduct of Human Engineering Studies. By Alphonse Chapanis, San Diego State College Foundation, San Diego 15, Calif., 1956, 73 p. Principles and guides relative to conducting valid studies on the person.

Introduction to Electrical Applied Physics. By N. F. Astbury, Philosophical Library, New York, 1957, 241 p, \$10.00. A brief survey of the physical sciences of greatest importance in electrical engineering including electromagnetic field and wave theory, electromechanical and electro-acoustical systems and electronic devices. Treatment is suitable for graduate engineers.

Servosystems Laboratory Manual. Servo Corporation of America, 1957, 32 p, \$2.00. Intended as a framework for an introductory laboratory course in servomechanism and feedback control systems, this manual stresses practical application of principles and presents seven integrated experiments.

Fasteners Handbook. By Julius Soled, Reinhold Pub. Corp., New York, 1957, 430 p, \$12.50. This book should be of primary interest to engineers concerned with the production of electronic equipment. Subject headings include: Rivets, Inserts, Screws, Bolts, Studs, Nuts, Washers, Retaining Rings, Pins, Metal Stitching, etc.

1957 Registry of Public Safety Systems. Edited by Ethel V. Sleeper, Communication Engineering Book Co., Monterey, Mass., 1957, 132 p, \$4.00. Listing of 20,000 mobile radio communications systems operated in police, fire, special emergency, highway maintenance and forestry conservation services. Licensees are also listed by frequency showing location and call letters.

Letters

Trade Name

DEAR SIRs:

I CALL your attention to the misuse of "Teletype" in the sixth paragraph of the pink block entitled "FCC Actions" on page 22 of the July 1, 1957 issue of *ELECTRONICS*.

At the same time I am glad to tell you that on page 20 of the same issue in the article entitled "Microwave System Eases Overload," the common noun "teletypewriter" is correctly used.

I am sure in view of your most helpful attitude as revealed in the correspondence with our former general patent attorney, Mr. Harold B. Whitfield, who had called your attention to a previous misuse in the December 1955 issue of *ELECTRONICS*, that the instant misuse is inadvertent. However, I am obliged to call it to your attention because a misuse of our trade mark in such a significant and authoritative publication as *ELECTRONICS* cannot be disregarded.

F. S. EWING
General Patent Attorney
Teletype Corporation
New York, N. Y.

Demodulator-Limiter

DEAR SIRs:

I WAS interested to read the article "Demodulator-Limiter for Control System Signals" in the September 1957 issue of *ELECTRONICS*. The author has done a fine job of describing several features of this circuit. I would like to point out, however, that this circuit was described in the October 1956 issue of *ELECTRONICS* in the article "Photoelectric Analog Function Generator." In the latter article I described the circuit and pointed up its linearity, especially in the millivolt region, and its low null drift. These features were of prime importance in the function generator application, whereas Mr. Johanson makes good use of the limiting action of the circuit.

It will also be evident from a comparison of the schematics in

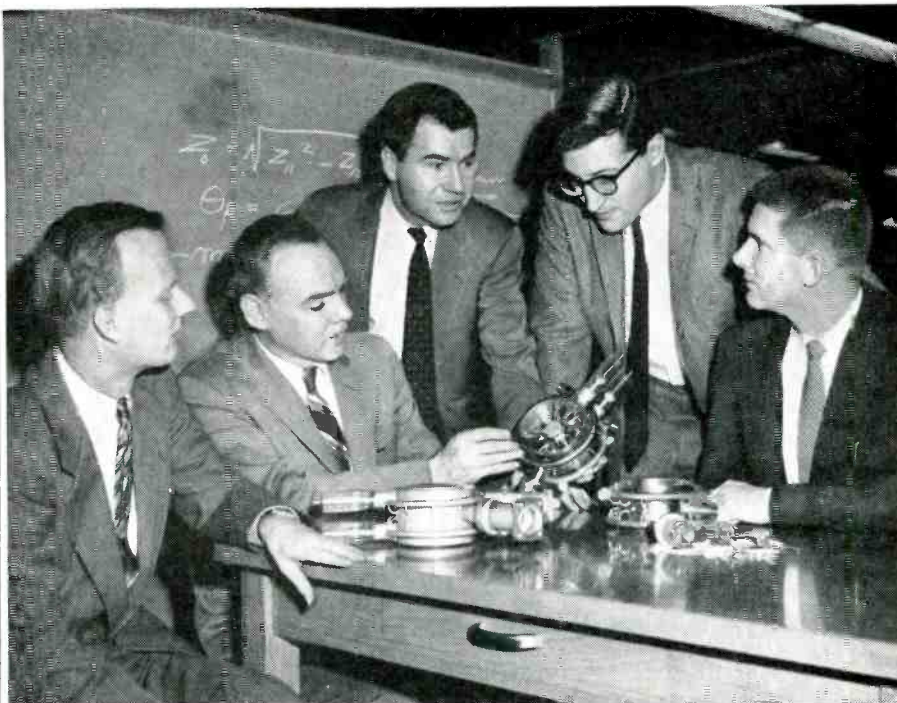

MEN WHO DEVELOPED THE PLATINOTRON—Raytheon microwave tube recently unwrapped from military secrecy—discuss its capabilities. Each man has known the satisfaction of contributing to revolutionary achievements.

Develop new microwave tubes in best equipped lab of its kind

It's nice to know that you're part of an operation that leads its field. Since the introduction of the magnetron, Raytheon has produced a major percentage of all the microwave tubes manufactured in this country.

To maintain this position, this Raytheon division depends on engineers and scientists in several areas from basic research investigations through production.

Work with one of these groups may hold a real future for you:

ADVANCED TUBE DEVELOPMENT—basic research work with group that produced the Amplitron.

BACKWARD WAVE OSCILLATORS—basic research to product refinements on these new tubes.

MAGNETRONS—design and development on 6 oz. miniatures to 300 lb. giants.

SPECIAL TUBES—fascinating work leading to new achievements.

For more facts, please write to D. Hamant at the address below.

RAYTHEON MANUFACTURING COMPANY
Waltham 54, Massachusetts

Are you the
ONE MAN IN THREE?



MICROWAVE AND POWER TUBE OPERATIONS

Excellence in Electronics

Continued

RIBBONS • STRIPS

★ PURE TUNGSTEN
★ MOLYBDENUM

★ THORIATED TUNGSTEN
★ SPECIAL ALLOYS

and OTHER METALS
IN

ULTRA THIN SIZES

to
TOLERANCES CLOSER THAN COMMERCIAL STANDARDS
by

OUR SPECIAL ROLLING TECHNIQUE

Note: for highly engineered applications—strips of TUNGSTEN and some other metals can be supplied

ROLLED DOWN TO .0003 THICKNESS

- Finish: Roll Finish—Black or Cleaned
- Ribbons may be supplied in Mg. weights if required

For HIGHLY ENGINEERED APPLICATIONS

DEVELOPED AND MANUFACTURED BY

H.CROSS CO.

15 BEEKMAN ST., N. Y. 38, N. Y.
WOrth 2-2044
TELEPHONE: COrtlandt 7-0470

Circle 329 Readers Service Card

Earn Extra Income in MOBILE-RADIO MAINTENANCE!



It's now a big business (650,000 installations) . . . fast-growing (70% increase just last year) . . . specialized . . . and high-paying!

Learn how to turn this opportunity into cash—write today for free booklet "HOW TO MAKE MONEY IN MOBILE-RADIO MAINTENANCE!" It's published as a service to radio engineers by Lampkin Laboratories, Inc., manufacturers of the well-known 105-B Micrometer Frequency Meter and 205-A FM Modulation Meter.



105-B



205-A

LAMPKIN LABORATORIES, INC.
Instruments Div., Bradenton, Fla.

At no obligation to me please send "HOW TO MAKE MONEY IN MOBILE-RADIO MAINTENANCE."

Name _____
Address _____
City _____ State _____

Circle 327 Readers Service Card

For **HEAVY DUTY**
WORK! Severest Electrical Services!



P-506-CE
Plug with Cap

**JONES
PLUGS &
SOCKETS**

500 SERIES

*Proven
Quality*



S-506-DB
Socket with
deep brackets

For 5,000 Volts
25 Amperes per
Contact Alter-
able by circuit
Characteristics.

Socket contacts phosphor bronze knife-switch type, cadmium plated. Plug contacts hard brass cadmium plated. 2, 4, 6, 8, 10, and 12 contacts. Plugs and sockets polarized. Long leakage path from terminal, and terminal to ground. Caps and brackets, steel parkerized (rust-proofed). Plug and socket blocks interchangeable in caps and brackets. Terminal connections most accessible. Cap insulated with canvas bakelite.

Write for Jones BULLETIN 21
for full details on line.

Jones HOWARD B. JONES DIVISION
CINCH MANUFACTURING CORPORATION
CHICAGO 24, ILLINOIS
SUBSIDIARY OF UNITED CARB FASNER CORP.

Circle 328 Readers Service Card

LETTERS

(continued)

the two articles that there has been a reversal of the signal and load terminals. These two sets of terminals are essentially interchangeable due to the symmetrical design of the circuit.

R. A. SINKER

President, Electrol, Inc.
Los Angeles 35, California

Wrong Price

DEAR SIRs:

THANK you for publishing a review of Symposium on Minimum Property Values of Electrical Insulating Materials in your August issue, p 384. However the price was incorrectly given as \$1. The book is priced at \$1.75.

The receipt of an order for the book accompanied by a tear sheet from ELECTRONICS brought this to our attention.

FRED F. VAN ATTA

Assistant Secretary
American Society for Testing Materials,
Philadelphia, Pennsylvania

Erratum

DEAR SIRs:

I WOULD like to bring to your attention two corrections needed on your July 1 issue of ELECTRONICS.

On page 186 you published my Helical Scan Nomograph under the byline "Chester W. Wood." Although this is, perhaps, a small error when compared with the vast amount of work which goes into the layout and makeup of an issue of ELECTRONICS, you can understand my disappointment.

I waited to satisfy my curiosity as to whether you would publish a correction in the August 1st issue. Either it was never called to your attention or I missed it as I was unable to find it.

I would also like to bring to your attention the fact that credit was not given to Donald G. Fink for either the equation of the nomograph or the drawing which I lifted bodily from his book, *Radar Engineering*.

CHESTER W. YOUNG
Sr. Research Engineer

Editor's Note: Our faces are red because we missed it when the issue came out. The name was set correctly by the printer when the type was set, but seems to have changed somehow during the running of the presses.

PROFESSIONAL SERVICES

BRIGGS ASSOCIATES, INC.

Engineering Services

ELECTRONICS **MECHANICAL**
Development — Manufacturing — Consulting
Special Machines — Instrumentation — Automation
Electron Tube Design, Materials, Reliability
10 DeKalb St. Broadway 9-2120 Norristown, Pa.

McCann Engineering Company

Consulting Mechanical Engineer

Design and Development of Test Equipment
for Synchros, Potentiometers, Gyros, Etc.
Redesign of Products—Trouble Shooting
Production—Automatic Machinery
Special Machines with Sequence, Form
Recognition, Dimension Decision and
Special Environment Features.
9210 So. Vermont Los Angeles 44, Calif.

ALBERT PREISMAN

Consulting Engineer

Television, Pulse Techniques, Video
Amplifiers, Patent technical consultation.
616 St. Andrews Lane, Silver Spring, Maryland

CROSBY LABORATORIES, INC.

Murray G. Crosby & Staff

Radio - Electronics
Research Development & Manufacturing
Communications, FM & TV
Robbins Lane, Hicksville, N. Y.
WE 1-3191

MEASUREMENTS CORPORATION

Research & Manufacturing Engineers

Harry W. Houck
Specialist in the Design and
Development of Electronic Test Instruments
Boonton, New Jersey

TELECHROME MFG. CORP.

Electronic Design Specialists
COLOR TELEVISION EQUIPMENT
Flying Spot Scanners, Color Synthesizers, Keyers,
Monitors, Oscilloscopes and Related Apparatus
Telemetering for Guided Missiles.
J. R. Popkin-Churman, Pres. & Dir. of Eng.
28 Ranick Dr. Amityville, L. I., N. Y.

DUNLAP ELECTRONICS, INC.

MANUFACTURING FACILITIES
RESEARCH & DEVELOPMENT
Specializing in Printed & Etched Circuits
Transistors—Pulse Techniques—Environmental
Test Facilities
3 Day Service on Printed Circuit Samples
764 Ninth Street Des Moines, Iowa
AT 8-0801

Eugene Mittelmann, E. E., Ph. D.

Consulting Engineer, Physicist

INDUSTRIAL - ELECTRONICS
RESEARCH DEVELOPMENT
Mathematical Analysis, Instrumentation & Control
High Frequency Heating
519 W. Washington Blvd., Chicago 6, Illinois
Phone: STate 2-3171

WHEELER LABORATORIES, INC.

Consultation—Research—Development
Microwave—UHF—VHF—VLF
Antennas and Components
Harold A. Wheeler and Engineering Staff
HUNter 2-7876 Great Neck, N. Y.
Antenna Laboratory Smithtown, N. Y.

ERCO RADIO LABORATORIES, INC.

Radio Communications Equipment

Engineering - Design - Development - Production
Our 27th Year in Air to Ground
Communication and Radio Beacons
Garden City • Long Island • New York

NIAGARA ELECTRON LABORATORIES

CONSULTATION - DESIGN - CONSTRUCTION
MFG. THE THERMOCAP RELAY

Specializing in solution of problems of electronic
and electro-physical instrumentation for the re-
search or analytical laboratory. Industrial plant
problems also invited.
Andover, New York Cable Address: NITRONLAB

YARDNEY LABORATORIES

Research-Design-Development

Electro-Chemical Generators of Energy
40-18 Leonard Street WORTH 6-3100
New York 13, N. Y.



MANUFACTURERS' REPRESENTATIVES

IN THE ELECTRONIC INDUSTRY

As a service to readers, **ELECTRONICS** presents the advertisements for some of the leading manufacturers' representatives in the electronic industry. These firms are qualified to help the *Manufacturer* with his distribution problems; the *Buyer* with his product needs.

REPRESENTATIVES!

This is a special section for Manufacturers' Representatives desiring advertising space in units smaller than the minimum run of book display space.

It offers you an economical means to keep in contact with the key people of the electronic industry who most naturally will be interested in your products and services as a source of supply or as a sales outlet for their products.

HORMAN ASSOCIATES, INC.
2017 "S" STREET, N.W.
WASHINGTON 9, D. C.
DECATUR 2-5705

SERVING
DELAWARE, MARYLAND
DISTRICT OF COLUMBIA
AND
NORTHERN COUNTIES
IN VIRGINIA AND WEST
VIRGINIA
TELETYPE NO. WA-559

REPRESENTING —

HEWETT-PACKARD CO.
SORENSEN & COMPANY INC.
VARIAN ASSOCIATES
BETA ELECTRIC CORP.
ELECTRO-MEASUREMENTS INC.
GERTSCH PRODUCTS INC.

SENSITIVE RESEARCH INST. CORP.
SANBORN COMPANY
KINTEL (formerly KAY LAB)
JOHN FLUKE MANUFACTURING CO.
BUDD STANLEY COMPANY, INC.
WEINSCHTEL ENGINEERING CO.

Complete Recalibration Laboratory

160,000 prospects!

In *Electronics* magazine the advertiser talks to 46,000 paid subscribers, plus 3 or 4 interested potential customers receiving each copy for pass-along reading . . . approximately 160,000 prospects

SAMUEL K. MACDONALD, INC.
manufacturers representatives over 25 years
1531 SPRUCE STREET, PHILA. 2, PA.

Territory:
Pennsylvania • New Jersey
Delaware • Maryland
Virginia • West Virginia
District of Columbia
Other Offices:
Pittsburgh
Baltimore
Washington, D.C.

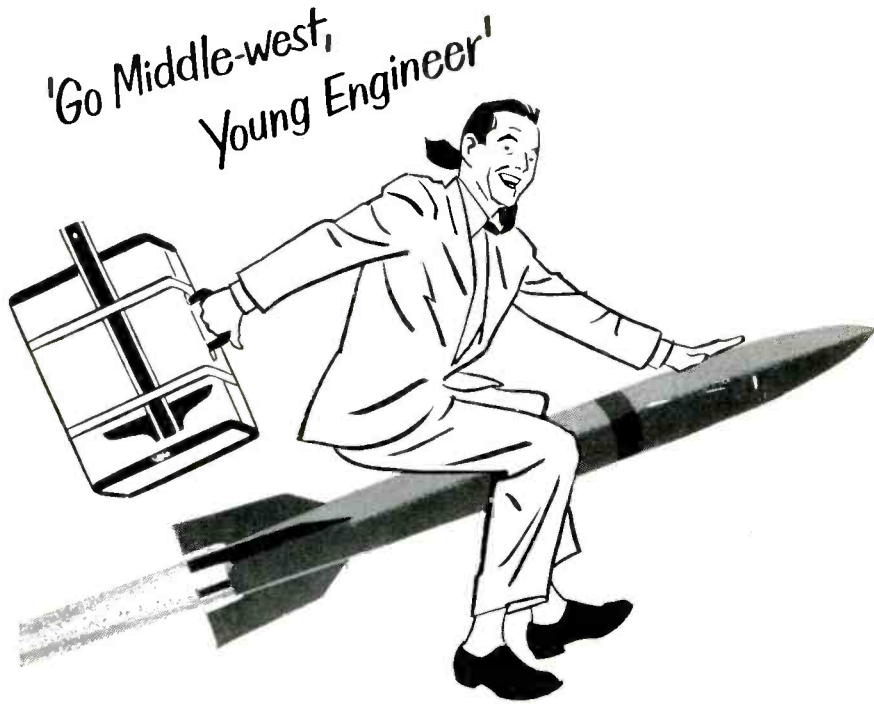

FOR THE FINEST JOB OPPORTUNITIES IN THE GUIDED MISSILE FIELD!

Yes, it's a fact. At Bendix Guided Missiles you'll enjoy living in an attractive community convenient to metropolitan areas and recreational centers, with experiencing job opportunities unrivalled in the guided missile industry.

As prime contractor for the vitally important Talos Missile, Bendix engineers are engaged in the widest possible range of missile work and enjoy unusual advancement opportunities.

There is no question about it—guided missile engineering is definitely the newest and most modern business, and, logically, the best future for engineers is working with a prime contractor on one of the nation's most important missile projects.

So that you may investigate thoroughly the many advantages of becoming a Bendix Guided Missile engineer, we

have prepared a thirty-six-page booklet giving the detailed story of the function of the various engineering groups, such as ram-jet propulsion and hydraulics, guidance, telemetering, steering intelligence, component evaluation, missile testing, environmental testing, test equipment design, system analysis, reliability, and other important engineering operations.

If you'd like to combine the advantages of living in the Middle West and an unparalleled chance for professional growth with one of the world's foremost missile builders, just mail the coupon today for your copy of the booklet "Your Future in Guided Missiles".

Bendix—prime contractor
for the **TALOS MISSILES**

Bendix Products Division—Missiles
403N, Bendix Drive, South Bend, Indiana
Gentlemen: I would like more information concerning opportunities in guided missiles. Please send me the booklet "Your Future In Guided Missiles".

NAME _____

ADDRESS _____

CITY _____ STATE _____

Follow the sun TO PHOENIX!

...where Motorola offers rewarding opportunities!

Work where it's fun to live. Advance your career—both in recognition and financial gain—at Motorola in Phoenix.

Your family will share your opportunity when you settle down in sunny, dry, healthful Phoenix! Tourists spend millions of dollars every year just to visit Phoenix. The attractions of this fabulous vacationland can be yours to enjoy year-round with Motorola!



If you are qualified for any of the positions below, write, wire or phone today.

ELECTRONIC ENGINEERS, MECHANICAL ENGINEERS, PHYSICISTS

Transistor Applications	Radar Systems Design
Microwave Techniques	Systems Test and Analysis
Pulse and Video Circuitry	R-F and I-F Circuit Design
	Servo Mechanisms

Write:

Mr. Kel Rowan
Western Military Electronics Center
Motorola, Inc., Dept. A-11
8210 E. McDowell Road
Phoenix, Arizona

Engineering positions also available at Motorola, Inc. in Chicago, Illinois, and Riverside, California.



MOTOROLA, INC.

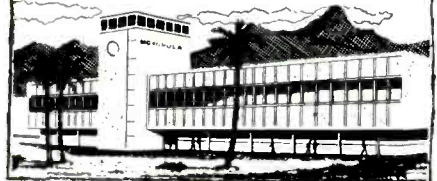

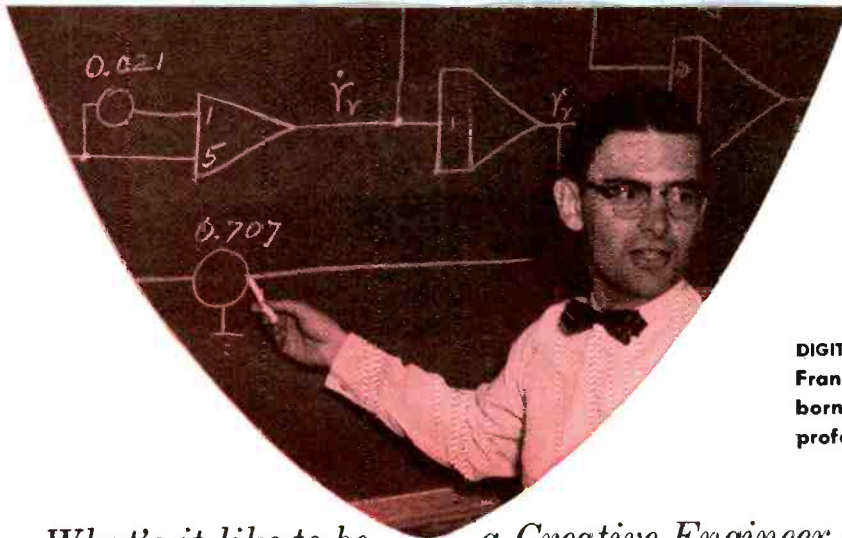

DIGITAL COMPUTER SYSTEMS ENGINEER Sherman Francisco tells why simulation studies of airborne computers offer a singularly challenging professional experience.

What's it like to be a Creative Engineer at

IBM

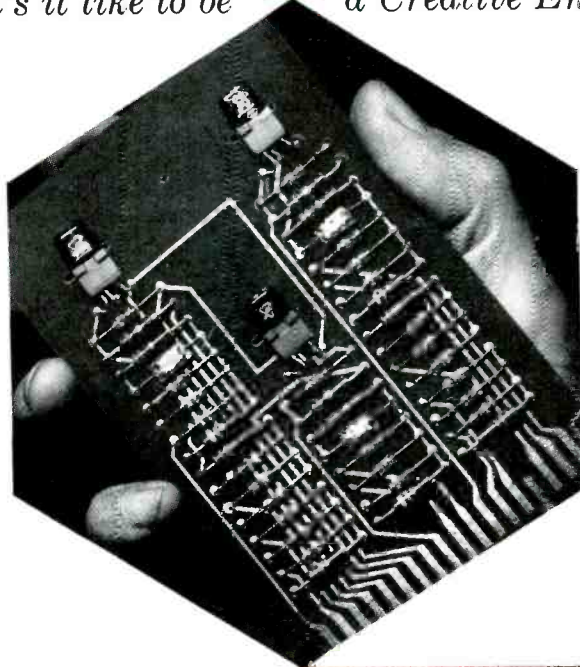

"Airborne computers present a special challenge to the creative engineer, because their systems must be planned and designed with flight situations in mind. Through simulation studies, we test computer systems right in our own labs—simulating both the dynamics of the aircraft and the environmental conditions encountered. My biggest thrill? To see my first simulated bombing mission!"

For those who can qualify, the engineering of digital computer systems at IBM Owego offers one of the most challenging assignments in electronics today. You can use your experience in: Instrumenting mathematical equations; programming operational steps; simulation studies; real time control; digital-to-analog conversion.

Challenging assignments for well-qualified E.E.'s, M.E.'s, Physicists and Mathematicians in:

- Digital computer systems and logic
- Radar systems
- Inertial guidance
- Test equipment development
- Electronic circuit design

FOR DETAILS, just write, outlining background and interests, to:

Mr. R. A. Whitehorne, Dept. 554K
 Mgr. of Technical Recruitment
 International Business Machines Corp.
 590 Madison Ave., New York 22, N. Y.

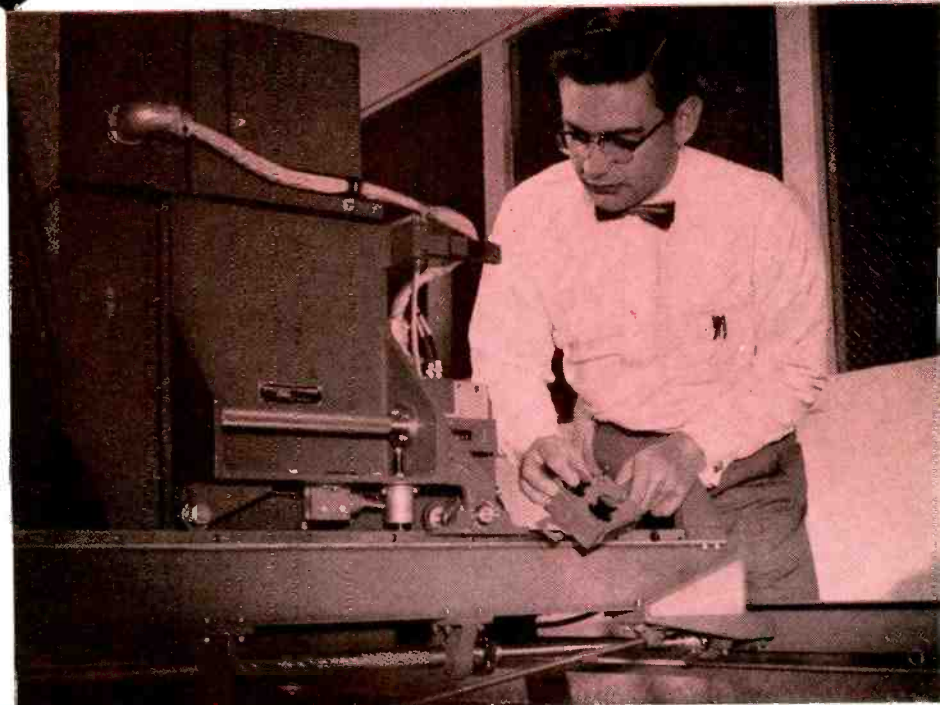

IBM

MILITARY PRODUCTS

DATA PROCESSING
 ELECTRIC TYPEWRITERS
 MILITARY PRODUCTS
 SPECIAL ENGINEERING PRODUCTS
 SUPPLIES
 TIME EQUIPMENT

Plants and laboratories: Endicott, Kingston, Owego, Poughkeepsie, Yorktown, N.Y.; Lexington, Ky.; Rochester, Minn.; San Jose, Calif.

ROUND-TRIP MISSILES ANSWER



ENGINEERS' QUESTIONS AT VUGHT

"Old Indestructible" Paid a \$3 Million Dividend in Data

When a missile can be flown . . . recovered . . . and flown again, it becomes an acquaintance. When a single *Regulus I* missile came home 15 times, it got a name.

"Old Indestructible" began her career by returning flight test information to Vought engineers. The missile gave the acid test to new launching methods, guidance principles, performance maximums and telemetering channels. Three flights, and the bird had paid for herself in fat data installments.

When the missile had been picked clean by Vought reliability and systems men, she joined the Navy. Fleet submariners and surface seamen were ready to operate *Regulus* as a target drone and nuclear weapon. Old Indestructible was chosen to teach them.

The missile qualified six Navy teams in *Regulus*

tactics, logistics and maintenance. Repeated launchings at 70,000 pounds thrust stretched her airframe. Flight and ground-run time on some components mounted above 1,000 hours. Operationally, however, the missile was sound when time came for her 16th and final flight, a shipboard launching in a simulated nuclear attack.

Thanks to Old Indestructible's dogged returnability, Vought engineers could design its reliability standards into every Navy-bound *Regulus*. Results were unprecedented. With the Fleet, *Regulus I* has completed well over 600 flights with outstanding on-target success probability.

Today, Vought missile men are using the recovery concept to foolproof a mightier missile. Their *Regulus II* has completed 20 flights to date. Significantly, six of these flights were made by one missile.

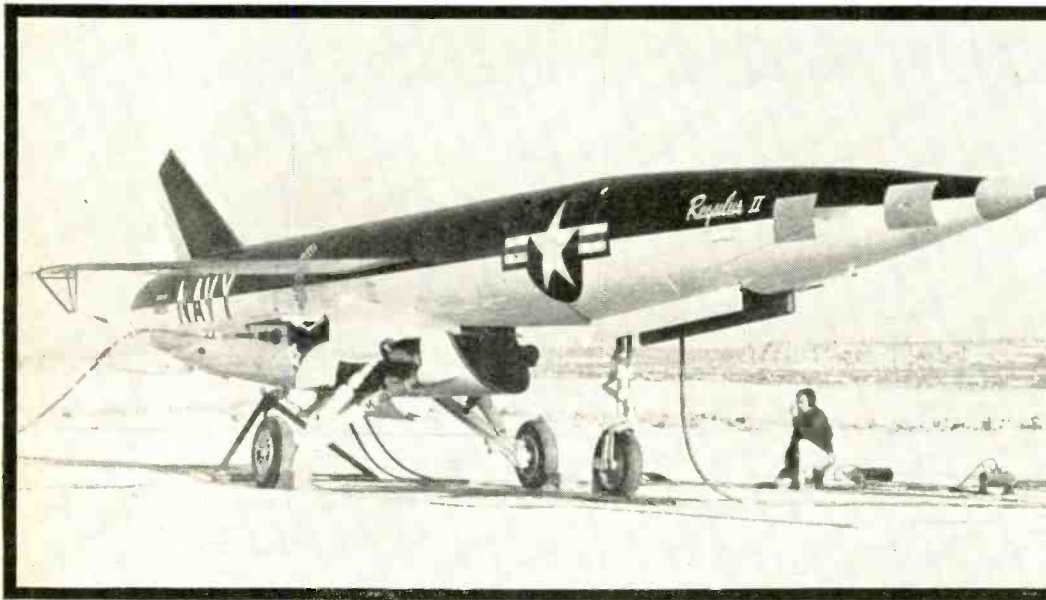

Swift, versatile *Regulus II* can strike from land or sea.

Nuclear subs, surface ships, shore batteries . . . they will all get the supersonic striking power of Vought's new *Regulus II*. This missile system weds marine and missile engineering, test range and shipyard, nuclear power and inertial guidance. It's a uniquely interesting and rewarding project — and one you can join through new, select openings.

For details on current openings in this and other Vought projects, write to:
C. A. Besio, Supervisor, Engineering Personnel, Dept. E-6

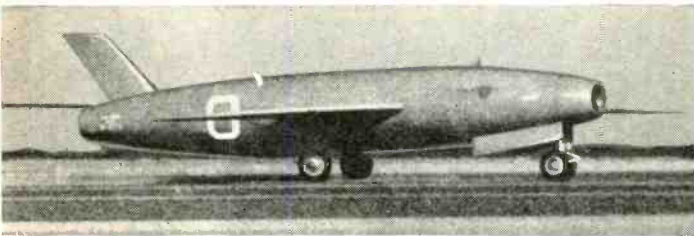

CHANCE
VOUGHT AIRCRAFT
INCORPORATED · DALLAS, TEXAS

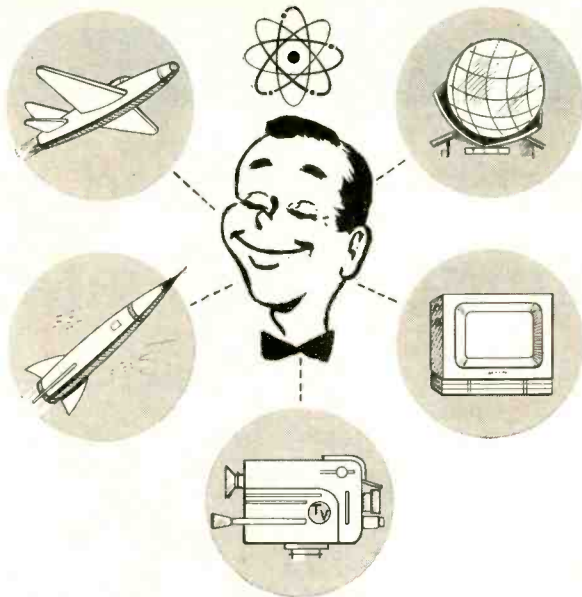

ENGINEERS!

PHYSICISTS!

Explore these unusual
OPPORTUNITIES
 at
Westinghouse

ELECTRONIC TUBE DIVISION, ELMIRA, N. Y.

Our fast-growing Laboratories provide immediate openings for a limited number of select **ENGINEERS** and **PHYSICISTS** in these challenging areas:

- **APPLIED RESEARCH**
- **ADVANCED DEVELOPMENT**
- **PRODUCT DEVELOPMENT & DESIGN**
 Cathode Ray, Camera, Power, Receiving and other special purpose Tubes.
- **MICROWAVE TUBES**
 Magnetrons, Traveling Wave Tubes, Klystrons, Reference Cavities and other devices.
- **APPLICATION ENGINEERING**

Previous experience in RESEARCH, DEVELOPMENT and DESIGN desirable.

If you are qualified for any of the above openings, we urge you to communicate with us at once by phone or letter, and arrange for an interview.

Write or send resume to Mr. W. Kacala, P.O. Box 284, Dept. M-3V, Elmira, N. Y., or phone collect Elmira 9-3611.

Westinghouse
 ELECTRONIC TUBE DIVISION ELMIRA, NEW YORK



ANTENNA
and
ELECTRONIC ENGINEERS!
 ARE
 YOUR
HANDS TIED?



DO YOU WANT FREEDOM FROM A ROUTINE JOB?

If so

MEMCO

offers you

- **FREEDOM** from red tape
- **FREEDOM** from stagnation
- **FREEDOM** to use your creative engineering talents
- **FREEDOM** to work on all phases of your project

To cut the knot write, wire or call

Mr. J. E. Richardson, Personnel Director

MARYLAND ELECTRONIC

Manufacturing Corporation
 5009 Calvert Rd., College Park, Md.
 WARfield 7-9200

(A suburb of Washington, D.C.)

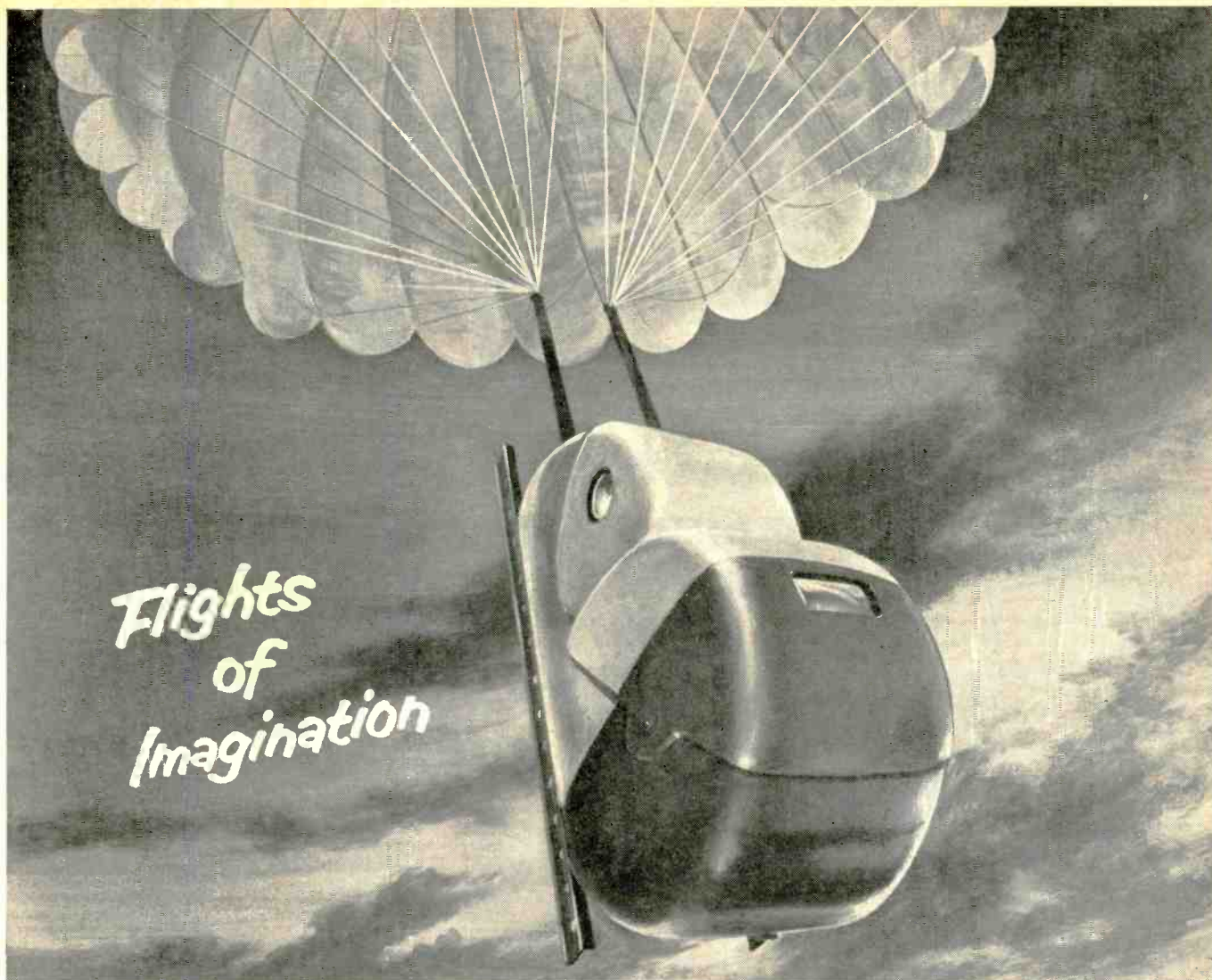

*Flights
of
Imagination*

Goodyear Engineers develop an escape capsule to bring jet airmen down alive

Here's a good example of what imagination and enterprise can do—given the opportunity that's offered bright young engineers at Goodyear Aircraft.

Above you see an escape device. It enables pilot and crewmen to leave an aircraft in distress—even while flying at supersonic speed—then float safely to earth in a watertight, airtight capsule.

Ingenuous as it is, this innovation is no more than typical of the achievements pouring out of Goodyear Aircraft—in airship design, electronics, radar structures, metals engineering and countless other projects. In all of them there is need for talent, training and unlimited vision.

If you have faith in your ideas and confidence in your ability to make them work, a rewarding career can be yours at Goodyear Aircraft. Our continued growth and diversification have required expansion of our engineering staffs in all specialties at both Akron, Ohio, and

Litchfield Park, Arizona. Available for your use are the most modern engineering and research laboratories, including a large computer laboratory.

Salaries and benefits are, of course, liberal. And if you wish to continue your academic studies, company-paid tuition courses leading to advanced degrees are available at nearby colleges.

For further information on your career opportunities at Goodyear Aircraft, write: Mr. C. G. Jones, Personnel Dept., Goodyear Aircraft Corporation, Akron 15, Ohio.

They're doing big things at
GOODYEAR
AIRCRAFT



ENGINEERS
PHYSICISTS MATHEMATICIANS
Designers



Important NEW Developments
create Advanced
Positions
AT MELPAR

Leading Research Laboratory in Suburban
 Washington, D. C.

Several long range systems development programs have recently been awarded to Melpar, the execution of which require our engineers and scientists to pioneer into the no-man's-land of science. Of a highly advanced nature, these programs are vital to the Nation's defense and include *weapons systems evaluation* in a variety of fields and over 90 diversified projects in *electronic R & D*.

These long term assignments have created challenging openings which you are invited to consider. As a Melpar staff member you will become a member of a small project team charged with responsibility for *entire* projects, from initial conception to completion of prototype. Your advancement will be rapid, thanks to our policy of individual recognition, which promotes you on the basis of your performance, rather than age or tenure.

Wire or phone collect, or write to:
Technical Personnel Representative



MELPAR Incorporated

A Subsidiary of Westinghouse Air Brake Company

3356 Arlington Boulevard, Falls Church, Va.

10 miles from Washington, D. C.

Openings Also Available at Our
 Laboratories in Boston and Watertown, Massachusetts.

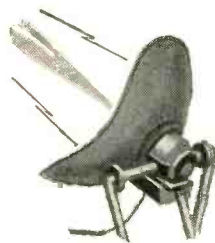

ENGINEERS

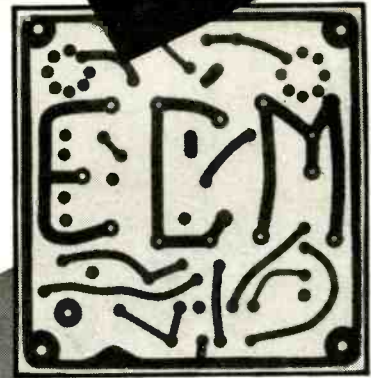

Exercise
your
ingenuity on
sophisticated
ECM systems

It is on the *deception* side that the high priority electronic countermeasures projects lie today.

Engineers at LMEE (Light Military Electronic Equipment Dept. of General Electric) are now developing highly sophisticated systems approaches to the problem of providing *total deception* for strategic aircraft. Many advanced technologies must be integrated to create the complex systems which can conceal the position of our own planes, while detecting the presence of an enemy and disrupting *his* electronic equipments.

Opportunities now exist for a number of engineers capable of this type of advanced systems thinking. They will work with a group of men whose special competence in this field has contributed greatly to LMEE's position as leading producer of radar jammers and other ECM equipments.

Please write in strict confidence to:
 Mr. RICHARD C. KIMM, ROOM 845



LIGHT MILITARY ELECTRONIC EQUIPMENT DEPARTMENT

GENERAL  **ELECTRIC**

FRENCH ROAD, UTICA, NEW YORK

BURROUGHS ALWAYS NEEDS *Good* ENGINEERS

A New Art is ~~Born~~... Recognized

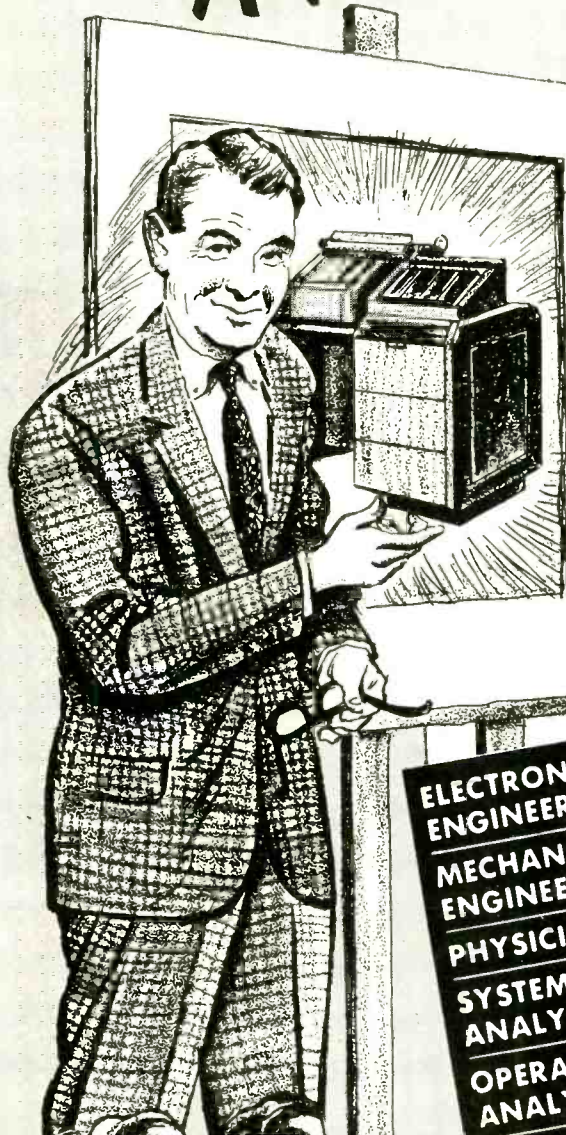

Inspired intellect, scientific knowledge and the rare ability to make a technological application of an idea is a new field of human accomplishment regarded today as a leading art. A fusion of such dynamically charged components — the lifeblood of any art — has brought amazing innovations into our business society, started a whole new trend in industrial thinking, and established computing as a legitimate art form.

Ideas born of this art, translated and adapted into computer techniques, are steadily carrying American industry to the threshold of complete electronic automation.

Scientific man's role as mentor and master strategist, in this impending era of automation, will be eased by groundwork laid by the computer today. And, as the engineer realizes the immense possibilities and potentials of his electronic tools, practical applications within the state of the art itself will open new, and possibly even wider, fields of inquiry.

It is in and toward these areas of uncharted thinking that the talented creative teams at our Research Center are now moving. If you contemplate an association with us in these pioneering efforts, YOU will find our program of planned progress an asset to your professional success, for it guarantees real career opportunities and a secure future for yourself and your family.

Our present needs are for people experienced in Electronic Digital Computers, Guided Missiles, Radar, Fire Control Systems and allied areas of electronics, with specific emphasis on men who by education or experience can qualify for the openings listed herein.

- ELECTRONIC ENGINEERS
- MECHANICAL ENGINEERS
- PHYSICISTS
- SYSTEMS ANALYSTS
- OPERATIONS ANALYSTS
- LOGICAL DESIGNERS
- MATHEMATICIANS

Write or Telephone
M. E. JENKINS
Placement Manager
PAOLI 4700
For Interview at Your Convenience

B
BURROUGHS CORPORATION
Research Center
PAOLI, PA.

On Philadelphia's Main Line,
Near Historic Valley Forge

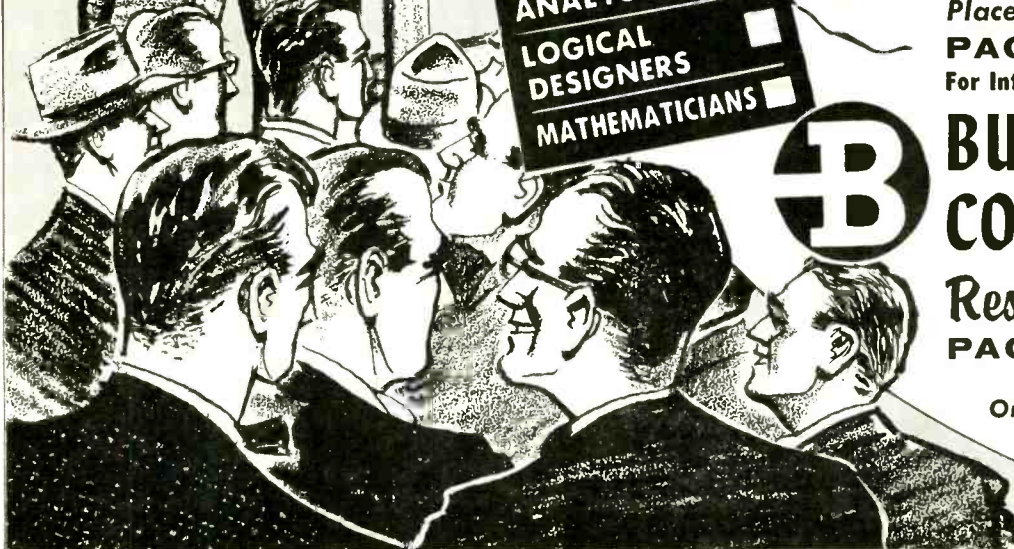

ENGINEERS • PHYSICISTS

*Big things
are happening*

in

MOTOROLA's
Chicago Civilian Research
and Development Laboratories

- Industrial Communications Equipment
- Consumer Products

Here is opportunity *unlimited* for men who like challenges and the rewards that go with accomplishment in non-military engineering assignments. This is your opportunity to advance your career while working in well instrumented laboratories and enjoying the benefits from association with men of the highest technical competence. There are many liberal employee benefits, including an attractive profit sharing plan.

You'll like living in one of the beautiful suburbs of the playground of the midwest, where there are endless social, cultural, and educational activities to choose from the year-round. Exciting life or quiet life—Chicago offers either.

Salary levels are open and commensurate with ability. Directly related engineering experience is *not* needed.

POSITIONS AVAILABLE IN:

- Two-way communications • Portable communications • Radio & TV (color)
- Component engineering • Transistor research and application • Microwave systems
- Servo-mechanisms • Field engineering • Communications Sales Engineering • Field service engineering

For full discussion of these opportunities — Write:

Mr. L. B. Wrenn, Dept. A
MOTOROLA, INC.
4501 Augusta Blvd., Chicago 51, Ill.



MOTOROLA

ENGINEERS

KNOWLEDGE IS POWER . . .
IN JOB PLACEMENT, TOO

You wouldn't undertake a technical project without first getting all the facts. Planning your next career move requires all the facts, too. And the best way to get them is through Abbott's, where 33 years of experience in placing professional men goes to work for you immediately.

CHIEF ENGINEER—Missiles Research & Development

CHIEF MECHANICAL ENGINEER—Instrument development

SUPERVISORY ENGINEER—New product development; timers, relays

ENGINEERING DEPT. MANAGER—EE, electronic instrument development

SR. RESEARCH ENGINEER—Radar, systems

MECHANICAL DEVELOPMENT ENGINEER—Servos and precision structures

DEVELOPMENT ENGINEER—Communications systems

PROJECT ENGINEER—Gyro R&D

SALARIES—\$10,000 to \$20,000

Of course, your reply will be held strictly confidential, and our client companies will assume all expenses and our service charges. Please send 3 copies of your resume to Mr. George R. Sandel, Director.



EMPLOYMENT SPECIALISTS
333 Washington Street, Boston 8, Mass.

RATES

"Employment Opportunities"

Displayed—The advertising inch is \$25.25 per inch for all advertising appearing on other than a contract basis. Contract rates quoted on request.

An advertising inch is measured 7/8" vertically on a column—3 columns—30 inches to a page.

Subject to Agency Commission.

Undisplayed—\$2.40 per line, minimum 3 lines. To figure advance payment count 5 average words as a line.

Discount of 10% if full payment is made in advance for 4 consecutive insertions.

Not subject to Agency Commission.

Send **NEW ADS** to **ELECTRONICS**, Class. Adv. Div., P. O. Box 12, New York 36, N. Y., for December 1st Issue Closing November 1st.

ENGINEER, ME OR EE

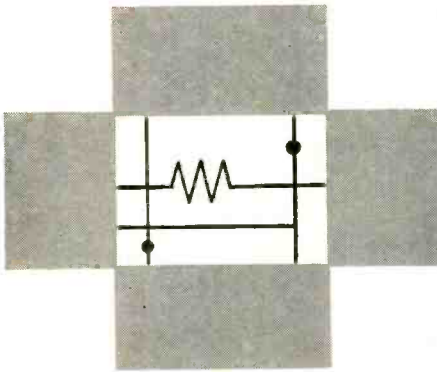

Packaging Specialist for Experimental Airborne Control System Circuits

AT
AIRCRAFT NUCLEAR PROPULSION
DEPARTMENT OF
GENERAL ELECTRIC

Effective packaging is receiving increased emphasis in this advancing development program. There is an opening now for an electrical or mechanical engineer qualified to package vacuum tube and magnetic amplifier circuitry for airborne application. Duties will include working with circuit design engineers and directing the activities of drafting designers and laboratory technicians—with full responsibility to follow designs from drafting board through service test model.

Requirements: At least 5 years' experience in packaging plus knowledge of Mil Specs, printed circuit techniques and equipment cooling.

PUBLICATION OF TECHNICAL PAPERS IS ENCOURAGED

Write in confidence to:
Mr. J. R. Rosselot
Aircraft Nuclear Propulsion Dept.



P. O. Box 132, Cincinnati 15, Ohio

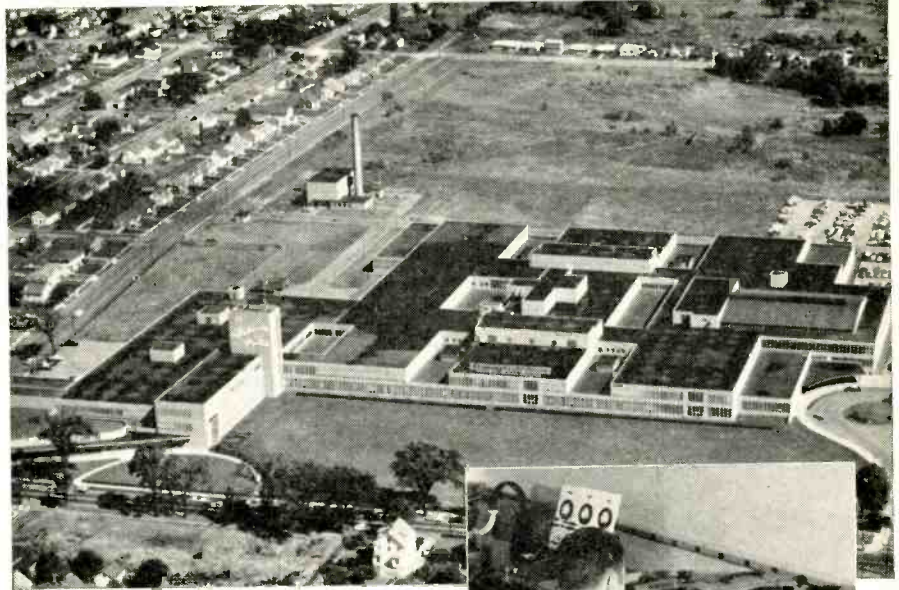

ELECTRICAL ENGINEERS...

measure your chances to GROW

Yes, we're growing and you can grow with us. In the 800,000 square-foot Stromberg-Carlson Electronics Center shown above is enormous potential for your personal and professional growth.

Five-fold expansion of our Company since 1942, plus continuing rapid growth, provide almost unlimited opportunity for your advancement.

Our electronics engineers are concerned with the design and development of industrial and consumer products as well as military electronic equipment ranging from small airborne receivers to complete radar systems.

If you join us, your responsibilities may include the design of *auto radios, high fidelity components, electromechanical devices, electronic switching, equipment engineering and packaging, data handling and test systems.*

You will be located in Rochester, New York—a beautiful, medium-sized city of fine homes, outstanding schools and vast facilities for leisure-time activities.

For an immediate interview, fill out the coupon below and rush it to us, or write to:

ARTHUR N. PAUL, *Director of Technical Personnel*



STROMBERG-CARLSON

A DIVISION OF GENERAL DYNAMICS CORPORATION

1417 N. GOODMAN STREET • ROCHESTER 9, NEW YORK



Name..... Phone.....
 Address.....
 College..... Degree.....
 Technical Experience..... Years.....
 Other Experience..... Years.....
 Type of Assignment Desired.....

senior electro-hydraulic engineer

with at least five years experience with aircraft electro-hydraulic servo valves. Experience in systems design of servo loops and components such as amplifiers, rams, valves, and follow-up devices. Ability to communicate effectively with analytical personnel, as well as detail design group, desired.

Generous moving allowances and many other employee benefits. Interviews arranged at company expense. All replies held in confidence.

Please send resumes to:
EMPLOYMENT MANAGER

LEAR, INCORPORATED

110 IONIA AVENUE, N.W. • GRAND RAPIDS 2, MICHIGAN

DO YOU NEED ENGINEERS WITH EXPERIENCE IN:

- Research
- Development
- Design
- Instrumentation
- Servomechanisms
- Missiles
- Audio Systems
- Control Systems
- Radar
- Computers
- Transistors
- Other Fields

Place an "ENGINEERS WANTED" advertisement in this EMPLOYMENT OPPORTUNITIES SECTION of ELECTRONICS. It's an inexpensive, time saving method of selecting competent personnel for every engineering job in the electronics industry. The selective circulation of ELECTRONICS offers you an opportunity to choose the best qualified men available throughout the industry.

For Rates and Information

Write:

CLASSIFIED ADVERTISING DIVISION

McGraw-Hill Publications

P. O. Box 12

New York 36, N. Y.

ENGINEERS

With a few years experience, for diversified assignments in design and development of electronic countermeasures.

Qualified and interested in research and study concepts on navigational guidance, radar, missile systems etc.

To engineers interested in opportunity to work at the top level of their skills, in a professional engineering atmosphere which encourages advanced thinking, Sanders has much to offer.

The favorable working and living environment is due to the engineering management which has led the company steadily forward since its organization 6 years ago . . . and to the location in the beautiful New Hampshire hill country just one hour from downtown Boston.

Inquiries should be addressed to

D. H. JOHNSON

 **SANDERS ASSOCIATES, INC.**

95 CANAL ST., NASHUA, NEW HAMPSHIRE

P
H
O
N
I
X
P
H
O
E
N
I
X
P
H
O
E
N
I
X

At the crossroads of opportunity
for men with vision in
Electronic Engineering

GOODYEAR AIRCRAFT CORPORATION

ELECTRONIC LABORATORY

Arizona Division
Litchfield Park, Arizona

A Subsidiary of the
GOODYEAR TIRE & RUBBER CO

**WE HAVE OPENINGS
IN OUR MODERN
LABORATORIES FOR
ADVANCED ENGINEERS
IN ELECTRONIC RESEARCH**

Long range research and
development projects

University of Arizona graduate
studies available under company
financed evening courses.

*Leisure Living At Its Best
"In the Valley of the Sun"*

Modern Inexpensive Housing

Send resume to: A. E. Manning

Engineering and Scientific Personnel

GOODYEAR AIRCRAFT

LITCHFIELD PARK
PHOENIX, ARIZONA

Similar opportunities available in
our
Akron, Ohio Laboratory

8 laboratories at FTL

**offer unlimited opportunities
to top engineers and scientists**

1. Radio Navigation
2. Missile Guidance
3. Electronic Countermeasures
4. Electronic Systems
5. Radio Communication
6. Physical-Chemical
7. Electron Tubes
8. Wire Communication

In suburban New Jersey—only a few minutes away from New York City—at least one of these 8 research and development "centers" comprising Federal Telecommunication Laboratories offers a solid future to you!

Whether your field is computers, data processing, radio communication, air navigation, missile guidance, electronic countermeasures, antennas, transistors, traveling wave tubes or telephone switching, you can be sure your assignment will be interesting, challenging and rewarding.

Opportunities at FTL are unlimited. Our program is long-range . . . commercial and military. We have the finest facilities . . . our future is expanding on both coasts. Ability reaches the spotlight quickly under our "small-company" project system.

Choose FTL-IT&T—where you build 2 careers in 1.

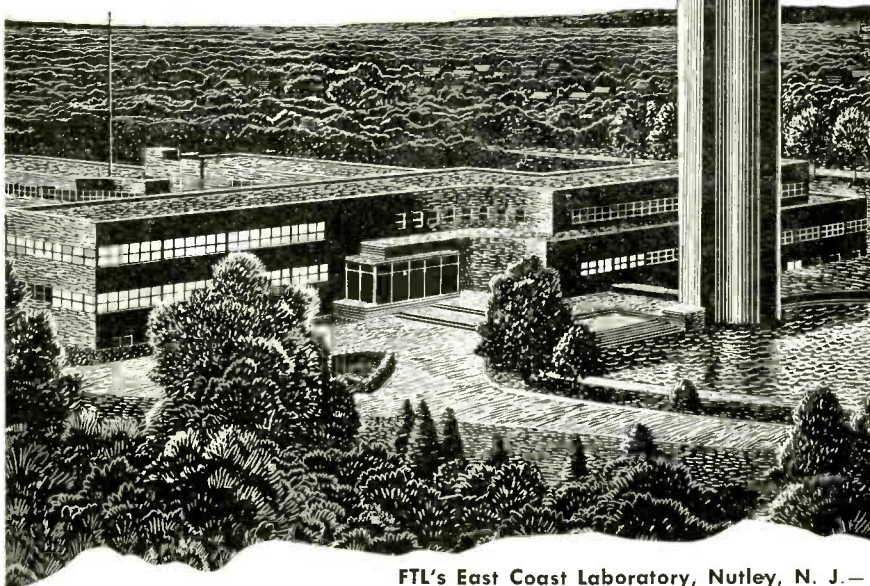

FTL's East Coast Laboratory, Nutley, N. J.—
only 28 minutes by bus from New York City

If you prefer CALIFORNIA

Opportunities for relaxed living and career-building also at FTL's West Coast Laboratories: *San Fernando, Cal., 15151 Bledsoe St.*—openings in Digital Computers, Inertial Navigation Systems and Infra Red Systems. *Palo Alto, Cal., 937 Commercial Street*—openings in Carrier Systems.



MAIL THIS COUPON TODAY E-11

Federal Telecommunication Laboratories
500 Washington Avenue, Nutley, N. J.
Please send literature describing opportunities
and benefits at FTL, in Nutley, New Jersey.

Name _____

Address _____

City _____ Zone _____ State _____

Federal Telecommunication Laboratories
A Division of INTERNATIONAL TELEPHONE
AND TELEGRAPH CORPORATION

HIGH-LEVEL OPENING FOR COUNTERMEASURES SPECIALIST

An unusual opportunity in an established company for a technical specialist proficient in
PROPOSALS • SYSTEM DESIGN • TECHNICAL LEADERSHIP
STARTING SALARY \$13,000

P-6338, Electronics
 Class. Adv. Div., P. O. Box 12, N. Y. 36, N. Y.

SENIOR RESEARCH PHYSICIST

Two top openings for men experienced in electro-luminescence or magnetics. Ph.D. required. Excellent salary and working conditions. Write to D. Bellat, Personnel Director.

TUNG-SOL ELECTRIC INC.
 200 Bloomfield Avenue, Bloomfield, N. J.

TECHNICAL REPRESENTATIVE

for an Eastern manufacturer of magnetic electronic components. Baltimore-Washington, Chicago, and Boston areas. Engineering and Sales background required. Please submit resume.

RW-6304, Electronics
 Class. Adv. Div., P. O. Box 12, N. Y. 36, N. Y.

ambitious?

OPPORTUNITIES WHICH LEAD TO MANAGEMENT

As an independent leader in the field of high permeability magnetics, we are expanding our creative engineering leadership. These are "threshold to management" positions for which we need

ELECTRICAL AND ELECTRONIC ENGINEERS

Choose your own avenue of development or application work in instrumentation, magnetic circuitry and magnetic materials.

If you can qualify for a really bright future, send experience summary to

Mr. Keith Krewson, Mgr. of Personnel



BUTLER 3, PA.
 (near metropolitan Pittsburgh)

TRANSFORMER ENGINEER

Salary to \$15,000 to design and develop small electrical transformer (Low frequency, high frequency, and pulse) for airborne and guided missile application. Resort area. Company client assumes fee and moving expenses.

MONARCH PERSONNEL
 28 East Jackson Blvd. Chicago 4, Ill.

FIELD SALES ENGINEER

For established prestige line of precision electronic laboratory instruments in the New York to Washington, D. C. Area.

Pioneer manufacturer (est. 1934), small company atmosphere and informality. Ideal country living—1 hour from N. Y. C.

Requirements: E.E. Degree, 3-5 years experience with electronic equipment. Sales aptitude or experience.

Please forward complete resume to:

BOONTON RADIO CORPORATION
 BOONTON, NEW JERSEY

WANTED GOVERNMENT CONTRACT PROCUREMENT MAN

Experienced contacting and soliciting government contracts for electronic, electro-mechanical and mechanical components and assemblies. Leading metropolitan New York manufacturer with extensive engineering and production facilities is interested in large volume contract work. Send complete details of experience and form of compensation arrangements desired to

P-6300, Electronics
 Class. Adv. Div., P.O. Box 12, N.Y. 36, N.Y.

ENGINEERS

If you have been looking for an Employment Agency that is skilled in the STATE OF THE ART of Technical Recruitment and RELIABILITY OF INFORMATION concerning positions, why not communicate with us at once! ALL POSITIONS FEE PAID.

FIDELITY PERSONNEL SERVICE
 1218 Chestnut St. Phila. 7, Pa.
Specialist in Aviation, Electronics and Nuclear

ELECTRONICS ENGINEER \$10-\$14,000.00 Yr.

Well known company seeks Supervisory Engineers with experience in Computer & Analytical devices. Should have Executive ability & Technical background.

For Confidential & Prompt Service
 Send resume to:
J. COOPER
 202 S. State—Suite 1100 Phone: Harrison 7-6337
 Chicago, Illinois

Electrical or Mechanical Engineer

Degree desirable, but not essential. Long established relay manufacturer has responsible opening for versatile engineer. Work in all phases of relay design and production. Prior relay experience not required. Fully equipped small company. Immediate recognition of effort. Excellent living conditions. Write P.O. Box 141, Frederick, Maryland.

YOUR ORGANIZATION

Is it complete?

Are you expanding it?

Making Replacements?

Naturally, you are anxious to secure the most suitable man or men available. You want men with the special training that will make them an asset to your organization. You can contact such men through an advertisement in this Employment Opportunities Section of **ELECTRONICS**.

Classified Advertising Division

ELECTRONICS

P. O. BOX 12
 New York 36, N. Y.

Electronic Engineers
Mechanical Engineers
Advancement... Security
...Responsibility

Professional personnel needed at all levels to fill responsible openings at this steadily expanding Division of Bendix Aviation Corporation. It's your chance to get specific assignments at the peak of the art in ELECTRONICS and MICRO-WAVE DEVELOPMENT and DESIGN. Good salaries, all employee benefits, ideal suburban living conditions. Whether you be a Department Chief or a Junior Engineer with less than one year's experience, we have the opening and the shoes for you to fill.

Address: Chief Engineer Dept. H



TRANSISTOR AND PRODUCTION SUPERVISOR AND ENGINEERS

For transistor production: experienced in germanium or silicon. Excellent opportunity for advancement. Top salary for qualified men. Call Mr. Becker at O'Regon 7-8400 or write
INDUSTRO TRANSISTOR CORPORATION
649 Broadway, New York 12, New York

INSTRUMENTATION ENGINEER OR PHYSICIST

Applicant should have a background of electrical engineering, physics, or engineering physics with additional education or experience in instrumentation. The work involves co-operation with Research, Development and Engineering Groups in a new, well-equipped laboratory.

Fields of interest are the use of electronics in experimental research, electrical measurements and instrumentation, radio-activity measurements and general engineering physics techniques.

If interested, write Mr. J. J. Rostosky, Linde Company, Division of Union Carbide Corporation, P. O. Box 8237, Indianapolis 24, Indiana.



"Linde" and "Union Carbide" are registered trade-marks of UCC

electronic engineers

- DESIGN ● DEVELOPMENT
- FIELD ENGINEERING

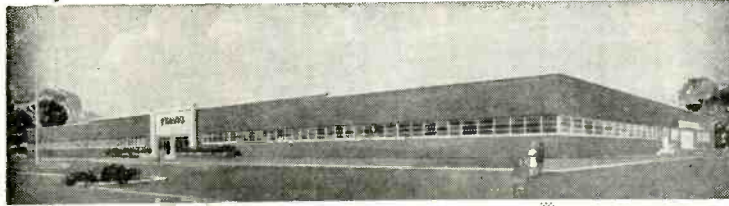

STAVID is engaged in design, development, modification, installation, testing and evaluation of military electronic and electro-mechanical equipment.

STAVID ENGINEERS possess an enviable reputation and are noted for their competence and diversification. You can fulfill your professional ambitions at STAVID.

(New air-conditioned Plant—65,000 square feet)

STAVID offers challenging permanent field assignments in New Jersey, the Boston, Mass. area, and other desirable locations throughout the U. S.

Call for interview arrangement or send complete resume to: Personnel Dept.

Opportunities available in the following fields for those persons with EE or ME degree with minimum of 3 years' experience or equivalent:

- Fire Control Radar
- Missile Electronics
- Coils, Transformers
- Transistors
- Filter Networks
- Instrumentation
- Microwave
- Servos
- Antennas
- Computers
- Simulators
- Telemetering
- Navigation Systems



STAVID ENGINEERING, INC.

Route 22, Plainfield, N. J. Plainfield 7-1600

CAREER OPPORTUNITIES

With a company making premium grade electronic equipment for aircraft for almost 30 years. Located in the beautiful lake region of Northern New Jersey, less than 35 miles from New York City.

- TRANSISTOR CIRCUIT PROJECT ENGINEER
- METHODS ENGINEERS
- GYRO DESIGN ENGINEER
- TECHNICAL WRITERS
- PRODUCTION ENGINEER
- CHIEF ENGINEER TO HEAD SERVO AND INSTRUMENT DEPARTMENT
- QUALITY CONTROL DEPARTMENT HEAD

Enjoy the pleasure of working in a new laboratory in a company whose products are known as the highest quality in the industry.

Write or call collect: Personnel Manager

AIRCRAFT RADIO CORPORATION

Boonton, N. J. DE 4-1800 — Ext. 238



Navigation Systems

Communication Systems

Servos

Transistors

Transmitters

Receivers

Antennas

RADAR

P.P.I. REMOTE REPEATERS

- VD 7" Upright
 - VE-7" Table Type
 - VF-5" "B" Scope "5" P.P.I.
 - VG-24" Plotting Table
 - VJ-12" Upright
 - VK-12" Upright
 - VL-12" Upright R.H.I. IND.
- All indicators are 110v 60 cyc.

RDO & APR-4

SEARCH RECEIVERS

The RDO is a very elaborate radar search receiver greatly improved over the APR-4. The set uses APR-4 tuning units, but is much more versatile, having input metering, D.B. output meter, automatic noise limiter and greater selectivity and sensitivity. The RDO is recommended when only the very best will do. Input 110/60 cys.



BC-342 BC-312

1.5-18MC Communication Receivers. The BC-312 Operates From 12V D.C. The BC-342 From 110V 60 Cyc. These Sets Incorporate a Crystal Filter B.F.O. Antenna Tuner Etc. We Can Supply These Receivers in Large Quantities.

SHORAN

AN/APN-3-AN/CPN-2

The AN/APN-3 and AN-CPN-2 are Precision distance measuring installations. This equipment operates on 225 mc. The range is 250 miles with an accuracy of 25 feet. This equipment is widely used by geological companies for prospecting and mapping. Power input is 110v 400 cyc and 28v DC.

Radalab Inc.

87-17 124th St., Richmond Hill 18, N. Y.
Phone Virginia 9-8181-2-3

OVERSEAS CUSTOMERS CALL US DIRECTLY BY
TELEX OVERSEAS TELETYPE TWX N.Y. 4-4361

COUNTER MEASURES EQUIPMENT

SEARCH DETECTION

- AN/APR-4 38-4000 MC RDO 38-4000 MC
- AN/APR-2 300 1000 MC SCR-616 145-600 MC
- AN/APR-5 1000-3100 MC
- AN/APR-6 1,000-10,000 MC

DIRECTION FINDING

- AN/APA-17 300-10,000 MC
- AN/APA-24 100-750 MC
- AN/APA-48 140-300 MC

PANORAMIC AND PULSE ANALYZING

- AN/APA-6 Pulse Analyzing
- AN/APA-11 Pulse Analyzing
- AN/APA-10 Panadapter
- AN/APA-38 Panadapter
- AN/ARQ-5 18 80 MC Receiver Indicator
- AN/ARQ 8 25-105 MC Barrage Rec-Trans Indicator
- AN/ARQ-10 1.5 MC-50 MC Receiver-Trans. Jammer Indicator
- AN/ARQ-1 Thru 12 also avail.
- AN/APA-23 Signal and Time Recorder

NOISE GENERATORS

- AN/URA-T1 AN/URA-2T MD-4/URA
- Shot-Noise, Bangpips, Tone, Random Keying, Output. These units will key any transmitter.

JAMMER TRANSMITTERS

- AN/APT-1 thru 10 25-3,000 MC AN/APQ-15
 - AN/APQ-1 thru 20
 - AN/SPT-Series
 - SCR-596 1.5-30 MC Barrage Ground Jammer
 - TDY, MRQ, SPT, SPQ, TPQ, IAN UPT-T1, T3, T4
- Many other countermeasures equipments avail. both hi and low power. These equipments can be used to test new radar and computer systems for susceptibility to jamming and other countermeasures. We can supply complete setups covering any freq. from 100 KC 10,000 MC, with power supplies for mobile operation.

MAR POINT TO POINT RADIO SET

Portable 225-398 mc point to point 10 chan. crystal controlled voice and mew radio set. This is a very late radio set used for point to point and ground to air communication. The transmitter output is 8 watts on 10 pre-set crystal controlled channels instantly selected by a hand switch. The REC is also crystal controlled with its own antenna. The set is incased in 3 water proof shock proof cabinets that may be set up in a few minutes on location. This equipment is ideal where a reliable radio link easily transported is needed. Power input is either 24 VDC 115/230V AC or DC. Complete sets avail. Write

AN/PRC-6

47-55 MC HANDI-TALKIE

This is the Standard MIL. F.M. Handi-Talkie With a Range of About 1 Mile. The Set Operates From Batteries With an Output of 25 Watts. The Set is Self Contained With Its Own Antenna. Weight is Approx. 6 Lbs. The Set is Crystal Controlled and Will operate with PRC, SCR 508, 608 SCR-300 Etc. Quantities Avail.

AN/TRC-1-3-4

100 MC RADIO-RELAY EQUIPMENT

The AN/TRC series is a mobile portable set for duplex or simplex radio telephone point to point communication. This set will operate with the CF series carrier systems to provide multi channel operation. The set operates on 100 MC with an output of 10 50 watts. The set is crystal controlled. Complete sets avail. Input 110v 60 cyc.

SCR-399-499

Mobile and fixed station high power radio sets: the SCR-399 is mounted in a HO-17 shelter. The SCR-499 is transported in carrying cases to be set up for field operation. Freq. of the sets is 2-18 mc. pwr output is 350w. Phone and C.W. 2 communication receivers are provided. Input is 110v 60 cys.

• RADALAB • RADALAB • RADALAB • RADALAB • RADALAB • RADALAB • RADALAB • RADALAB •

COMMUNICATIONS EQUIPMENT CO.

PULSE TRANSFORMERS

- 352-7150. Primary 50 ohms. Secondary 1000 ohms 12,000v. 12.0 Amp. Pulse: 1 or 2 usec. at .001 duty ratio. Fitted with magnetron well and bifilar winding for filament supply. \$22.50
- MAGNETRON PULSE TRANS. #964:** Prim. imp. 30 ohms. 1600 v. pulse. Secondary imp. is 1250 ohms. 12 KV pulse. Turns ratio sec:pri. is 7.5:1. Duty ratio is 0.001 at 1.2 usec. Bifilar winding 1.2A. \$9.50
- RAYTHEON WX 4298E:** Primary 4kV. 1.0 USEC. SEC. 16K-16 AMP DUTY RATIO: 001 400 CYCLE FIL. TRANS. "BUILT-IN" \$17.50
- GE #K-2482A:** Primary: 9.33 KV. 50 ohms imp. Secondary: 28 KV. 450 ohms. Pulse length: 1.05/5 usec. @ 635/120 PPS. PK Power Out: 1,740 KW Bifilar; 1.5 amps \$62.50
- GE #K-2748-A:** 0.5 usec @ 2000 Pps. Pk. Pwr. out is 52 KW impedance 40:100 ohm output. Pri. volts 2.3 KV 1K Sec. volts 11.5 KV Pk. Bifilar rated at 1.3 Amp Fitted with magnetron well. \$24.50
- K-2745:** Primary: 3 1/2 KV. 50 ohms Z Secondary: 14/12.6 KV 1025 ohms Z. Pulse length: 0.25/1.0 usec @ 600/800 PPS. Pk. Power 200/150 KW. Bifilar 1-3 Amp. Has "built-in" magnetron well. \$32.50

PULSE NETWORKS

- H-616 10KV, 2.2 usec., 375 PPS, 50 ohms imp. \$22.50
- H-615 10KV, .85 usec., 750 PPS, 50 ohms imp. \$22.50
- H-605: 25 KV, "E" CKT. 1.5 usec. 400 PPS. 50 Ohms Impedance, 5 sections. \$62.50
- 7-5E3-1-1200-67P, 7.5 KV "E" Circuit, 1 microsec. 200 PPS, 67 ohms impedance 3 sections. \$7.50
- 7-5E3-3-200-67P, 7.5 KV "E" Circuit, 3 microsec. 200 PPS, ohms imp. 3 sections. \$12.50
- G.E. #3E (3-84-810) 8-2-24-405 50P4T; 3KV "E" /2000 PPS/50 ohms/2 sections. \$6.00
- G.E. #3E (3-84-810) 8-2-24-405 50P4T; 3KV "E" CKT Dual Unit; Unit 1, 3 sections. 0.84 Microsec. 810 PPS, 50 ohms imp; Unit 2, 8 Sections 1.24 microsec. 405 PPS, 50 ohms imp. \$6.50
- #632: "E" Network, 1600v., .6 usec/2 usec. 2000 PPS/350 PPS. 30 Ohms Imp. \$7.50

PULSE MODULATOR

MIT. MOD. 3 HARD TUBE PULSER: Output Pulse Power 144 KW (12 KV at 12 Amp). Duty Ratio: .001 max. Pulse duration: 0.5, 1.0, 2.0 microsec. Input voltage: 115 v. 400 to 2400 cps. Uses: 1-715B, 1-829B, 3-72's, 1-73. New. Complete with pressurized housing \$135

MICROWAVE PLUMBING

X-BAND—RG, 52/II WAVE GUIDE

- PARABOLOID DISH, 18" diam. Spun Aluminum 8" Focus For AN/APS-8. \$45.00
- 3 CM. DIPOLE and Feed Assembly (May be used with above dish) 8-inches long. \$5.00
- FLEXIBLE SECTION 9 in. long. Cover-to-Cover \$5.50
- ROTARY JOINT (APS-6) Sperry PT #658275, 180 deg. rotation, choke to choke. Has "Built-in" Di-Coupler, 20 DB, with "N" Takeoff \$17.50
- 3 CM. DIPOLE FEED, 15" L. for APS-15. \$14.50
- MITERED ELBOW, Cast aluminum, 1 1/4" x 5/8" W.G. W. E. Flanges, "E" Plane. \$3.50
- 3 CM. ANTENNA ASSEMBLY: Uses 17" paraboloid dish, operating from 24 vdc motor. Beam pattern: 5 deg. in both Azimuth and elevation. Sector Scan; over 160 deg. at 35 scans per minute. Elevation Scan; over 2 deg. Tilt. Cys: 24 deg. \$35.00
- Cross-Guide Directional Coupler, UG-40 output flange. Main Guide is 6" Long, with 90 Deg. "E" Plane bend at one end, and is fitted with Std. UG 39/UG 40 Flanges. Coupling figures: 20 db Nominal. \$22.50
- Bulkhead Feed-thru assembly. \$12.00
- Pressure Gauge Section with 15 lb. gauge. \$10.00
- Directional Coupler, UG 40/U take off 20db. \$17.50
- MAGNET AND STABILIZER CAVITY For 2141 Magnetron \$24.50
- 90 degree elbows, "E" Plane 2 1/2 radius. \$8.50
- Beacon/receiver unit. Complete with dual klystron mount, TR/ATC section, duplexer, and 30 mc IF-Mixer unit. Originally designed for 9000 mc receiving using 723A/B. New, less tubes. \$22.50
- Klystron mount for 732A/B. Front end of microwave receiver (90-3), with balanced mixer crystal mt. and iris coupling for AFC. less tube. \$15.00

10 CM.—RG48/U Waveguide

- Waveguide to Coax, adapter. Matches RG48/U waveguide to RG 44/U rigid coax. Complete with flanges. "T" match. \$15.00
- 10CM ECHO BOX: Tunable from 3200-3333 Mc. For checking out radar transmitters, for spectrum analysis, etc. Complete with pickup antenna and coupling devices \$17.50
- POWER SPLITTER for use with type 726 or any 10 CM Shepherd Klystron. Energy is fed from Klystron antenna through dual pick-up system to 2 type "N" connectors. \$12.50
- LHTR, LIGHTHOUSE ASSEMBLY. Parts of RT39 APG 5 & APG 15 Receiver and Trans. Cavities w/ assoc. Tr. Cavty and Type N CPLG. To Recv. Uses 2C40, 2C43, 1B27, Tunable APX 2400-2700 MCS. Silver Plated. \$15.00
- McNally Klystron cavity for 2K28 or 707B, tunes 2700-2900 mc. Complete with tuning vanes. \$5.00

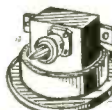

3000 MC WAVEMETER

Mfd. by G.E. for Armed Services 3000-3700 MC. Comes furnished with variable attenuator, coax. adaptor cord, Cal. chart and pickup antenna. Has output jack for external meter or other monitor device. Resonance indicator is 3 1/2 20 microamp meter. Brand new, in portable wooden carrying case \$75.00



DYNAMOTORS

TYPE	VOLTS	INPUT AMPS	OUTPUT VOLTS	AMPS	Price
BDAR83	14		375	.150	\$6.50
POXK-15	14	2.8	220	.08	8.95
DM33A	28		540	.250	3.95
B-19	12	9.4	275	.10	5.50
DA-3A*	28		500	.050	
			300	.260	3.95
			150	.010	
			14.5	5.	
PE 73 CM	28	19	1000	.350	10.50
DAG-33A	18	3.2	450	.08	2.50
BDAR 93	28	3.25	375	.150	6.95
			† Less Filter	* Replacement for PE 94.	
PE 94, Brand New					5.95

INVERTERS

- 800-1B Input 24 vdc, 62A, Output: 115 V, 800 cy. 7A. 1 phase. Used excellent. \$18.75
- PE-218H: Input: 25/38 vdc, 92 amp. Output 115V 300/500 cy. 1500 Volt-ampere. NEW. \$32.50
- PE206: Input: 28 vdc, 36 amps. Output: 80 V 800 cy. 500 volt-amp. Dim. 13 x 5 1/2 x 10 1/2. New. \$22.50
- EIGOR—ML 3011-5. Input: 13.75 V. 18.4A. Output: 115V/400—, 3φ. 0.95 PF. 100 VA. New. \$37.50
- LELAND #10563. Input: 28 vdc/12A. Output: 115 vac/400 cycle/3 phase, 115 va. Slightly used, ex. cond. \$32.00

BROADBAND VIDEO AMPLIFIER

Navy type AM-518/SSA: input data: 2 channel, 70 ohms Impedance each channel; output data: 2 channels, 50 ohms each channel; 1 to 4 volts overall gain; 100 cycle to 10 MC frequency range. Power required 115 volts, 1 phase, 60 cycle, 13 1/2" wide x 17 1/2" high x 26 1/2" deep, overall. Mfr. Bendix Aviation Corp. Used, excellent \$112

343 Canal St., New York 13, N.Y. Dept. E-11 Chas. Rosen Phone: Canal 6-4882

KURMAN GENERAL NORTH ELECTRIC GUARDIAN VOICE ELECTRIC CLARE WESTERN ELECTRIC A LARGEST STOCK OF RELAYS IN THE WORLD STRUTHERS DUNN ADVANCE AUTOMATIC SIGMA POTTER BRUMFIELD LEACH ELECTRIC

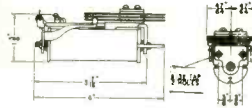

TELEPHONE TYPE RELAYS

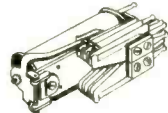

PRODUCTION QUANTITIES IN STOCK—IMMEDIATE DELIVERY

These relays are suitable for the majority of all applications.

The real ALL PURPOSE RELAY

Telephone type relays have been standardized so that coils and frames of most manufacturers can be interchanged without affecting adjustments. A wide variety of applicable combinations are thus possible from a comparatively small number of relays.

Listed below are frames and coils from our stock. They may be purchased separately. However, a complete relay consists of coil and frame. In ordering complete relays, specify which coil with which frame, i.e. F101 with K117.

For coils with typical rating see "Automatic Electric Time Delay" below. For example: 500 ohm coil with nominal rating of 24 VDC and 48 ma will operate continuously below 66 VDC.

FRAMES



(For Cost of Relay Add Price of Frame to Price of Coil)

Stock #	Contacts	Ea*	Stock #	Contacts	Ea*
F101	1A	1.25	F181	3A, 1C	2.25
F102	2A	1.50	F182	3A, 2D	2.75
F103	1A	1.75	F183	3A, 1B, 1D	3.00
F104	4A	2.00	F218	3A, 1B, 1C, 2D	3.50
F105	5A	2.25	F165	4A, 1B	1.25
F193	6A	2.50	F219	4A, 2B	2.50
F127	3A	3.00	F220	4A, 1C	2.50
F139	10A	3.50	F221	4A, 1B, 1C	2.75
F106	1A, 1B	3.50	F200	5A, 1B	2.50
F107	1A, 2B	1.75	F222	5A, 2B	2.75
F140	1A, 3B	2.00	F223	5A, 1B, 2C	3.50
F211	1A, 1B	2.25	F185	5A, 1B, 1C	2.75
F109	1A, 1C	1.75	F224	5A, 2B, 1C	3.25
F110	1A, 2C	2.25	F186	5A, 4B	2.25
F141	1A, 1C	2.25	F117	7A, 1C	2.75
F176	1A, 1D	1.75	F187	6A, 3B	3.25
F134	1A, 1E	2.25	F184	6A, 1C	3.00
F177	1A, 1E	2.00	F201	7A, 1B	3.00
F108	1A, 1B, 1C	2.00	F189	9A, 1C	3.75
F152	1A, 1B, 2C	2.50	F190	11A, 1B, 1C, 1D	5.00
F195	1A, 1B, 1D	2.00	F191	15A, 1B	5.00
F212	1A, 1B, 2D	2.50	F120	1B	1.25
F196	1A, 2B, 1C, 1D	2.50	K212	2B	1.50
F153	1A, 2B, 1C	2.25	F134	2B	1.75
F178	1A, 3B, 1D	2.50	F133	1B, 1C	1.75
F213	1A, 1C, 1E	3.00	F225	1B, 2C	2.25
F214	1A, 2C, 1E	3.50	F203	1B, 3C	2.75
F111	2A, 1B	1.75	F183	1B, 1D	1.75
F157	2A, 1B, 1C	2.25	F204	1B, 2D	2.75
F148	2A, 1D	2.00	F167	2B, 1C, 1D	2.50
F197	2A, 2D	2.50	F168	2B, 3C	3.00
F142	2A, 2C	2.00	F226	2B, 2C	2.75
F137	2A, 2C	2.00	F172	2C	1.50
F171	2A, 2C	2.00	F123	2C	2.00
F143	2A, 3C	3.00	F145	3C	2.50
F215	2A, 1B, 1D	2.25	F124	3C	3.00
F216	2A, 1C, 1D	2.50	F146	6C	4.00
F154	2A, 1C, 1E	2.25	F206	8C	5.00
F217	2A, 1C, 1E	3.75	F149	15A, 1D	2.00
F179	2A, 2E	3.00	F227	2C, 1D	2.50
F198	3A, 1B, 1C	2.75	F151	1D	1.50
F162	3A, 1B, 1D	2.25	F152	2D	2.00
F163	3A, 1B, 1D	2.50	F206	2C	4.00
F180	3A, 2B	2.25			

A = Normally open; B = Normally closed;
C = Double throw; D = Make before break;
E = Break, make, break

ACCESSORIES FOR TELEPHONE TYPE RELAYS

Clare	CR1	Molded Bakelite Cover 2 1/2" x 2 3/8" x 4 3/8"	#CR1.....	.60
Clare	CR3	Steel Cover 2 1/16" x 1 1/16" x 4 3/8" overall	#CR3.....	.60
Clare	BR4	Short Relay Bracket	#BR4.....	.15

Orders Under \$10 Remittance With Order. Plus Approximate shipping charges (overage will be returned).

TERMS—All prices F.O.B. Our Plant. Rated Firms Net 10 days: All Others Remittance with Order.

ALL MERCHANDISE IS GUARANTEED AND
MAY BE RETURNED FOR FULL CREDIT

Prices listed with asterisk (*) are subject to QUANTITY DISCOUNTS

1.9as quoted
10.4910%

Cable address: UNIGENCOR, N. Y.

COILS

(For Cost of Relay Add Price of Coil to Price of Frame)

Stock #	Ohms	Ea*	Stock #	Ohms	Ea*
K136	0.3	1.00	K109	1000	1.50
K137	3.8	1.00	K250	1000h	1.25
K133	5.0	1.00	K251	1100	1.50
K102	17	1.00	K136	1200	1.50
K244	40	1.00	K131	1300	1.50
K156	50	1.00	K252	1300h	1.25
K157	75	1.25	K112	1400	1.50
K198	125	1.25	K200	1470	1.50
K246	160	1.25	K139	1600	1.75
K247	182	1.25	K112	2000	1.75
K169	200	1.25	K253	2000h	1.50
K248	250	1.25	K155	2500	2.00
K153	300	1.25	K154	2500h	1.75
K199	375	1.25	K113	3000	2.25
K154	400	1.25	K255	3000h	2.00
K104	450	1.25	K181	3200	2.25
K105	500	1.25	K182	3300	2.25
K249	500h	1.00	K114	3600	2.50
K132	600	1.50	K115	6500	2.75
K134	700	1.50	K201	11300	3.00
K135	800	1.50	K167	12000	3.25
K108	900	1.50			



h = 1/2 wound coil

SLOW MAKE COILS

Stock #	Ohms	Ea*	Stock #	Ohms	Ea*
K132	33	2.00	K259	200/1600	3.00
K146	125/1300	3.00	K147	500/1500	3.25
K205	200/1500	3.00	K148	500/1500	3.25
M204	700	2.75	K206	2000	3.00
K241	788	2.75	K243	3100	3.25
K242	800	2.75			

SLOW MAKE & RELEASE

Stock #	Ohms	Ea*	Stock #	Ohms	Ea*
K237	8	1.75	K239	600	2.50
K188	200	2.25	K240	800	2.50
K238	300	2.25			

SLOW RELEASE

Stock #	Ohms	Ea*	Stock #	Ohms	Ea*
K185	1.98	2.00	K211	100/1300	3.00
K186	3.2	2.00	K124	200	2.00
K149	3.9	2.00	K206	350	2.25
K209	10	2.00	K207	500/1300	3.00
K210	20	2.00	K187	788	2.25
K161	30	2.00	K150	800	2.25
K123	75	2.00	K151	1000	2.25

DUAL COILS

Stock #	Ohms	Ea*	Stock #	Ohms	Ea*
K216	3/1000	2.00	K220	250/750	2.25
K213	3.2/500	2.00	K221	250/1000	2.25
K214	5/1300	2.00	K222	250/1000	3.50
K261	20.6/20.6	2.00	K265	300/450	2.25
K192	20/400	2.00	K266	300/500	2.25
K163	25/200	2.00	K267	400/500	2.50
K262	50/125	2.00	K223	400/2000	2.50
K215	50/300	2.00	K106	500/1000	2.25
K141	50/2000	2.25	K224	500/1300	2.25
K216	100/100	2.00	K144	500/1800	2.50
K164	100/1000	2.00	K155	550/550	2.75
K166	125/125	2.00	K225	600/1000	2.50
K142	125/1300	2.00	K226	700/1300	2.50
K217	150	2.00	K168	800	2.50
K166	125/125	2.00	K225	600/1000	2.50
K142	125/1300	2.00	K226	700/1300	2.50
K164	200/200	2.00	K155	550/550	2.75
K263	200/450	2.00	K145	1000/1000R	2.75
K143	200/1000R	2.00	K227	1000/6500	3.25
K218	200/1300	2.25	K194	1300/1300	2.75
K219	200/2000	2.50			
K264	250/250	2.25			

R = Resistance winding

A-C COILS

Stock #	Ohms	Ea*	Stock #	Ohms	Ea*
K256	5.6	1.75	K121	100	2.50
K258	70	2.25			

AUTOMATIC ELECTRIC TIME DELAY

AWSTeighted Spring Assembly; when used with ASO or ASA relay provides an overall operating delay of approx. 2 seconds. Provided with single normally open contacts.

Following types available:

Volts	12	24	48	60	150	250	300	300R	300RE	300RE	300RE	300RE	Each
12	36	80	150	150	RE28	#R308.....	3.00						
18	47	72	250	250	RE39	#R309.....	3.25						
24	60	83	300	300	RE30	#R310.....	3.25						
48	81	37	1300	1300	RE31	#R311.....	3.75						
115	170	38	3300	3300	RE32	#R312.....	4.25						

AVR Vibrating Reed Assembly; When used with ASO, BSO, RBA, or ASA to secure overall release delay adjustable between 1 and 15 seconds. Can also be used with slow operate relay to secure operate delay adjustable between 1 and 15 seconds and in self-acting circuits to generate time pulses.

Following types available:

24	40	60	200	RF71	#R313.....	3.50
115	202	17	3300	RF73	#R314.....	4.00

Send for latest Circular.

Universal RELAY CORP.

Formerly Universal Relay Corp.

42 WHITE ST. NEW YORK 13, N. Y. • WALKER 5-9642

CAPACITOR SPECIALS

4 mfd-3000V \$4.95

1 mfd-7500V \$7.50

Qua. Discount

Mfd	Volts	Price	Mfd	Volts	Price	Mfd	Volts	Price
.001	10KV	5.25	.5	1500	.59	4	5000	24.95
.001	50KV	24.95	5	2000	1.16	4	7500	59.50
.0025	10KV	5.95	5	2500	1.29	4	10KV	74.50
.005	25KV	29.95	5	3000	2.98	5	15KV	PUR
.01	1500	.55	5	4000	3.25	5	330	1.19
.01-.01	3000	.40	5	5000	3.05	5	600	1.95
.02	25KV	12.95	5	7500	5.75	5	1000	1.69
.015	16KV	14.50	5	25KV	38.50	5	5000	27.50
.02	8000	4.75	5-5	600	.49	2x5	400	.89
.02	10KV	5.25	5-5	9000	8.95	2x5	600	1.19
.02	20KV	9.95	5-1	2000	.32	6	330	1.29
.025	50KV	32.95		115VAC	.32	6	600	1.29
.03	7500	4.25		1	600V	.44		
.04	17KV	7.95		1	1000V	.69		
.05	2500	.75		1	1500V	.99		
.05	7500	4.25		1	3000V	1.75		
.05	100KV	89.50		1	3000V	2.95		
.05-.05	12KV	8.95		1	3600V	2.45		
.08	12.5KV	7.95		1	4000V	4.75		
.1	1250V	.25		1	5000	6.25		
.1	1500V	.45		1	6000	8.95		
.1	2000V	.65		1	7500	7.50		
.1	2500V	.69						

ELECTRON TUBES

Many New Additions In This Issue. Check Carefully

Consistently High Quality — At Sensible Prices!

Specialists in Jan., W.E., Subminiature, 5000/6000 Series and Receiving Types

Guaranteed • Unused • Boxed • 1st Quality • Write for Complete List

OA2	.75	SBP4	3.00	308B	10.00	1654	2.00
OA3/VR75	.75	5C22	24.00	311A	5.50	1740(W.E.)	3.00
OB2	.70	5CP1A	6.50	311C	1.50	1760(W.E.)	3.00
OC3	.75	5D21	5.50	313C	2.50	1768(W.E.)	3.00
OD3	.75	5HP1	2.25	313CD	2.50	1821(W.E.)	3.00
1AD4	1.10	5J23	Write	313CD	2.50	1821(W.E.)	3.00
1B24	5.00	5FP7	.75	328A	3.50	1850A	Write
1B24A	15.00	5J30/Z666	4.00	332-A	39.50	5513	150.00
1B26	1.00	5JP2	3.50	338A	3.75	5517	.90
1B32/532A	.25	5JP5	5.50	339A	9.00	5528/C6L	5.00
1B35	3.35	5LP1	12.50	350A	2.35	5599/FG57	8.50
1B40	2.00	5R4WGY	3.00	350B	2.35	5638	2.75
1B63A	19.00	5Y3WGT	1.00	354A	2.25	5639	5.75
1N21	.10	6AJ4	1.25	355A	10.00	5642	1.00
1N23	.10	6AK4	.75	359A	1.50	5654/6AK5W	1.25
1N48	.40	6AK5W	1.00	371B/VT156	.75	5656	4.00
1N52	.65	6AS6	1.00	375A	10.00	5670	1.30
1N65	.85	5B4G	.75	393A	4.50	5676	.65
1N70	.65	6B8	.40	396A/2C51	3.00	5678	.75
1P23	1.75	6BA6W/5749	1.25	401A/5590	2.75	5687	2.00
1P24	1.35	6BM6A	30.00	403A/6AK5	.90	5693	4.50
1P25A	17.50	6C4W	4.00	403B/5591	2.90	5721	125.00
1P30	1.25	6C6L/5528	5.00	404A/5847	12.50	5725	1.50
1P37	3.50	6C21/450TL	13.50	407A	2.50	5726/6AL5W	.65
1P41	2.50	6J4	1.00	408A	2.75	5744	1.00
1U4	.38	6J7GT	.50	412A	3.50	5744	1.00
1Z2	1.25	6S7J	.60	416B	30.00	5787WA	5.00
CE2C	2.00	6SN7SWG	1.75	417A/5842	12.00	5794	5.00
CL-2	10.00	7E5/1201	.20	421A/5998	3.50	5798	11.00
2B1	3.95	7A7	.20	422A	7.00	5800/VX41	4.00
2C39A	10.00	8D21	Write	GL434A	5.00	5844	.50
2C39AM	10.00	12DP7	10.00	GL502	1.50	5802	4.50
2C40	6.95	12DP7A	20.00	UE578	7.00	5812	1.00
2C43	7.50	27	.20	KU-610	3.50	5814	1.00
2C51/396A	2.75	FG-27A	28.00	Z666/5J30	5.00	5819	23.95
2C53	9.75	28D7	.80	GL-673	12.50	5829WA	3.00
2D21W	.95	FG-32A	4.25	721B	7.00	5840A	4.50
2E24	2.25	FG-57	6.00	723A/B	7.00	5841	30.95
2E25	3.50	FG-95	17.50	724B	.60	5851	2.00
2E26	2.95	FG-166	15.00	726A	5.00	5852/TE5	5.00
2E35	1.80	FG-190	7.00	726B	14.00	5876	7.00
2J21A	3.50	33	.20	726C	12.00	5879	1.30
2J22	3.50	35TG(surp)	2.00	750TL(surp)	30.00	CK5886	3.75
2J37	9.00	VCS0/32(cap)	8.00	802	2.00	5896	2.00
2J54	25.00	56	.20	803	1.50	5915	.60
2K25	13.50	QK60	20.00	805	4.00	5933/807W	1.40
2K30/410R	115.00	QK61	21.50	806	7.50	5965	1.00
2K45	35.00	FG81A	3.10	807	1.10	5975	2.50
2N155(CBS)	3.75	100R/451	1.75	807W/5933	1.50	5981/5650	50.00
2N255(CBS)	2.90	100TH(surp)	6.25	809	2.50	5998/421A	3.50
2V3G	.65	100TL(surp)	11.00	811	2.40	6004	2.00
3A5	.50	FG-105	15.00	812	3.25	6021	3.00
3B24	1.50	120	.50	813	8.75	6073	1.50
3B24WA	10.50	F-128A	10.00	814	2.50	6096	1.40
3B25	5.00	VXR-130	1.00	815	3.25	6099	1.25
3B26	3.95	R161	35.00	826	.50	6100/6C4WA	2.00
3B28	3.75	FG-166	12.00	829B	8.00	6108/BS213	3.95
3B29	4.75	FG-172	13.50	830B	.35	6109/BS404	3.95
3C22	59.50	FG-178A	9.50	832A	6.75	6111	3.75
3C23	3.95	QK-181	12.50	833A	39.00	6112	3.75
3C24/24G	1.70	QK202/5721	125.00	837	1.25	6113	1.25
3C33	6.00	203A	2.25	866A	1.45	6130/3C45	4.75
3C45	6.75	205F	1.00	866JR	1.50	6136	2.00
3D23	4.00	215A	10.00	869B	45.00	6161	45.00
3E29	8.00	217A	6.00	872-A	.90	6186	2.00
3J30	25.00	217C	5.00	872-A(GE)	2.75	6187	4.00
3J31	30.00	220	.50	889	35.00	6189	2.50
3K20000LK	Write	242C	9.00	889RA	100.00	6201	2.50
4-65A(surp)	15.00	250R	7.95	902PI	2.00	6211	1.10
4-125A	30.25	249B	2.75	917	1.30	6264	10.00
4-250A	35.00	249C	3.95	918	1.10	6288(Taylor)	12.50
4-1000A	95.00	HK253	5.00	927	.95	6485	1.30
4B24/EL3C	4.50	HK-257B/4E27	7.40	954	.10	6550	4.20
4C35	15.00	259A	Write	957	.30	6555	39.95
4J21	75.00	272A	4.50	958/958A	.35	8005	3.95
4J36	70.00	274B	.80	CK1007	.45	8008/872A	3.25
4J37	70.00	282B	3.50	CK1026	2.35	8020	1.00
4J78	150.00	287A	2.20	R1130B	10.50	Transistors	
4PR60A	30.00	293A	16.00	HY-1269	3.35	AND MANY OTH-	
4X150A(surp)	19.00	FP265	20.00	1609	1.50	ERS IN STOCK	
4X500A(surp)	70.00	304TL	12.50	1622	1.60	WRITE FOR LAT-	
4X500F	40.00	304TH	12.50	1626	1.15	EST TUBE LISTINGS.	
EL5B/4B22	5.50	307A	.50	1635	1.60		

BRAND NEW SYLVANIA TEST EQUIPMENT

LABORATORY SYNCHROSCOPES

Model 402 & 402A

A "must" scope for working with pulses, fast rise time, wave shapes, & TV

Features

1. Electronically regulated supply
2. Coax connector inputs
3. Push-pull deflection
4. Built-in metered voltage calibrator
5. Sweep continuously variable from 0.2 to 800 usec/in.
6. Internal trigger generator 500, 1,000, 2,000 & 4,000 p.p.s.—200 v. peak output. Trigger delay adj. from 75 usec before to 25 usec after start of sweep—Sweep trigger has fixed 90 usec delay
7. Weight 110 lbs., size 17" x 16" x 22".

\$369.50

Model 402

Model 402A Includes "RF Detector & wide band amplifier."

\$389.50

VTVM ADVANCE LAB

Model 301

Measured 0 to 1,000 volts 17 meg input Z
0-1000 volts A.C. 2.7 meg input Z
20 to 20,000 c.p.s.

Measures D.C. current up to 10 amps.

Resistance Measurement

\$59.50

0 to 10,000 meg ohms

TRANSCONDUCTANCE TUBE TESTER

MODEL 620

Tests all latest tubes including series string types

Features

1. Illuminated meter
2. Leakage tests directly in resistance
3. Internal roll chart, spins quickly
4. Heater cathode leakage test
5. Tests all T.V. picture tubes with 228 adaptor.
6. Sockets for all type tube boxes

\$79.50

7" OSCILLOSCOPE

MODEL 403

Features

1. D.C. Coupling
2. Identical V.&H. amplifiers
3. Flat to 500 KC
4. Built-in calibrating voltage
5. High gain—0.01 volts RMS/in. deflection
6. Sweep 5 cycles to 50 K.C. Size 17" x 11 3/8" x 19 1/2"

\$249.50

ADDITIONAL TEST EQUIP'T

Measurements Model 80 **\$415.00**

Measurement Model 78C **\$75.00**

NC300 receiver **\$325.00**

TS 375 A/U VTVM Model 400A-HP-VTVM
G.R. VTVM Model 726A
RCA Distortion & noise meter type 69C
RCA Sweeper. Model WR94B
Shallcross 760 DC kilovolt meter
Synchroscope MIT Radiation Lab
Write for prices

TERMS: 25% Deposit with Order. Balance C.O.D.—or Send Full Remittance with Order. Well Rated (D&B) Firms, Net 10. All Items Subject to Stock Depletion and Price Variation Without Prior Notice. All Merchandise Fully Guaranteed for Cost of Merchandise Only. Minimum Order \$10.00.

Walker 5-7000

WRITE FOR "BARRY'S GREEN SHEET" OF EQUIPMENT BARGAINS.
LATEST SEPT. 1, 1957 ISSUE OFF PRESS

Cable: Barrylect, NY
Telegrams: Barry, Fax, NYC
Tlx: Y1-3731 (attended)

BARRY ELECTRONICS CORP.

512 BROADWAY N.Y. 12, N.Y.

TUBES

- JAN and Commercial
- Advertised Brands Only!
- Special Prices To Quantity Buyers
- Guaranteed • Look & Compare
- From 10%-95% Below Manufacturers Prices

RECEIVING TUBES

Write for Special Prices,
Quantity Buyers

1A3	6SK7
1H5/GT	6WA/GT
2A3/G	6W6/GT
3A5	6Y6/G
6AB7	7A6
6AC7	7C4
6AC7W	7H7
6AK6	12AV7
6AT6	12AX7
6BA/G	12C8
6CA	12SC7
6F5	12SH7
6J4	12SL7/GT
6J4WA	1AN7
6J6W	25AV5/GT
6SC7/GT	25BQ6/GT
6SH7	VR-105
	VR-150

SPECIAL PURPOSE & TRANSMITTING TUBES

CEP-120	\$.49	5D21	6.99	801A	.42
CK-507AX	1.10	5D23	9.50	802	2.35
CK-521AX	1.10	7C22	49.95	803	2.00
EF-50	.59	10	.39	805	3.75
EM-3GA	39.50	10Y	.29	807	1.10
FP-62	2.95	15E	1.20	807W/5933	1.50
HF-100	7.49	35TC	3.25	814	2.49
HY-65	1.40	100TH	6.95	815	1.99
HY-114B	.59	100TL	10.95	826	.75
1F23A	4.75	203A	2.50	828	8.00
2C34/RK34	.29	204A	17.50	829B	8.50
RK-59	1.88	205B	1.99	830B	1.05
RK-65/		207	39.95	832A	6.75
5D23	9.50	211/VT4C	.49	836	1.20
VR-78	.59	262B	12.50	838	3.50
WE215A/VT-5		271A	12.99	841	.59
10Spec/VT-25A	6.25	276A	7.25	845	3.49
45Spec/VT-52	.26	279A	7.50	851	6.49
30Spec/VT-67	.26	282A	3.49	852	15.00
VT-127A	2.75	282B	3.75	860	3.49
VT-158	10.50	286A	7.50	861	14.00
ZB-120	.49	294A	8.00	864	.69
1N40	4.50	304TH	9.95	865	.49
1P30	1.35	304TL	22.50	918	1.49
2B22	.49	307A	.85	927	1.25
2C22	.29	310A	3.45	954	.19
2C26	.29	316A	.59	955	.29
2C39	4.00	328A	3.50	956	.25
2C39A	10.50	329A	3.25	958A	.35
2C40	7.95	350B	5.99	958A	2.99
2C42	8.49	HK354C	14.95	1608	2.99
2C43	8.00	388A	1.49	1611	.79
2C44	1.35	403B/5591	2.75	1613	.95
2C46	5.25	434A	6.66	1619	.92
2C51	2.75	446A	.49	1624	1.00
2C53	9.90	483	8.99	1626	.29
2E24	2.19	485	6.95	1632	.59
2E27	3.95	559	.99	1642	.39
2E41	1.35	HY-615	4.99	8002R	18.50
2G22	2.29	701A	.49	8005	4.50
3C28	5.95	703A	1.75	8012	1.85
3C33	5.99	708A	2.99	8022	2.00
3D23	4.99	713A	.96	8025A	2.25
3E29	8.00	715A	2.00	9001	.70
4C27	8.95	715B	6.49	9002	.50
4D21	19.50	717A	14.50	9003	1.25
4E27	6.95	800	.49	9044	.19
			1.29	9006	.19

CATHODE RAY TUBES

2AP1	\$1.95	5HP4	2.49
2AP1A	5.44	5JP1	8.75
2BP11	7.99	5JP4	3.99
3AP1	2.50	5LP1	13.99
3AP11A	4.95	5LP5	5.95
3EP1	1.50	5RP2	12.95
3FP7	2.50	5NP1	1.99
3GP1	2.00	9LP7	9.00
3HP7	2.95	10KP7	12.95
5AP1	2.75	12DP7/A	
5BP1	2.45		
5CP4	2.75		18.95
5CP1	2.25		
5CP1A	12.49	12GP7	12.95
5CP11A	9.50	902P1	2.89
5FP7	2.50	902A	2.89

THYRATRONS

2D21	5.79	3C23	3.75
2D21W	1.29	3C45	5.50
CSB	3.99		
FG-105	11.99	5C22	22.50
FG-154	9.95	269A	8.50
FG-172	13.45	394A	2.99
FG-190	12.90		
KU610	2.45	884	1.00
2C33/RX233A	.69	885	1.10

KLYSTRON

2K22	\$14.50	2K54	12.95
2K23	14.50	707A	2.55
2K25	14.75	707B	3.75
2K28	29.50	723/AB	7.99
2K33A	49.00	726A	4.50
2K35	99.50	726B	15.00
2K45	34.95	726C	12.50

TR AND ATR TUBES

1B24	5.99	709A	1.69
1B26	1.00	721A	1.49
1B29	2.39	721B	7.00
1B32/		724A	1.15
532A	.99	724B	.89
471A	1.25	1960	1.89

RECEIVING TUBES

1A3	.59	6AL5	.49	6B4/G	.59	6J6W	.49	6Y6/G	.54
2A3/G	.69	6AN8	.89	6C4	.27	6J7/GT	.69	7A6	.44
2A7/G	.19	6AT6	.49	6C8/G	.36	6SG7/GT	.32	7C4	.13
3D6	.24	6AV5/GT	1.15	6F5	.32	6SH7	.34	7H7	.38
3Q4	.49	6AV6	.49	6J4	1.40	6W4/GT	.61	12AX7	.64
6AG5	.49	6AW8	.95	6J4WA	2.45	6W6/GT	.74	12SC7	.31

ONE OF THE LARGEST SURPLUS DEALERS IN THE COUNTRY

FAY-BILL

DISTRIBUTING
CO. DEPT. E1

418 Broome St., N. Y. 13, N. Y.

Telephone CA 6-8404

All boxed and fully guaranteed. Special quantity discount—10% on 100 or more of same type. Minimum order \$10.00. Thousands of other types in stock. Send us your requirements. F. O. B. New York 25% deposit with order or if paid in advance save C. O. D. charges. Rated firms net 10 days. Prices subject to change without notice. For fast service ask for Sy.

REPLIES (Box No.): Address to office nearest you
c/o This publication Classified Adv. Div.
NEW YORK: P. O. Box 12 (36)
CHICAGO: 520 N. Michigan Ave. (11)
SAN FRANCISCO: 68 Post St. (4)

BUSINESS OPPORTUNITY

Radio & Cathode ray tube manufacturers interested getting newest production methods from experienced Sr. Eng. or training technicians for a two years period. BO-6406, Electronics.



ENGINEERING DEGREES IN E.E.
Under & Postgraduate Major Electronics May be earned by HOME STUDY or residence work.
(P.I.U. at present operating as a College of Engineering only.)
5719-G Santa Monica Blvd.
Hollywood 38, California

Wanted Now

General Radio Type 716-C CAPACITANCE BRIDGE

Either cabinet or rack mounting
Engineering Dept.

THE NARDA ULTRASONICS CORP.
178 E. 2nd Street, Mineola, L. I., N. Y.

CASH PAID! Sell your surplus electronic tubes. Want unused, clean transmitting, special purpose, receiving, TV types, magnetrons, Klystrons, Broadcast, etc. Also want military & commercial lab test and communications gear. We swap too, for tubes or choice equipment. Send specific details in first letter. For a fair deal write, wire or telephone: WALKER 5-7000
Barry, 512 Broadway, New York 12, N. Y.

SEARCHLIGHT SECTION

(Classified Advertising)

RATES DISPLAYED

The advertising rate is \$21.75 per inch for all advertising appearing on other than a contract basis. Contract rates quoted on request. AN ADVERTISING INCH is measured 7/8 inch vertically on one column, 3 columns—30 inches—to a page.

EQUIPMENT WANTED or FOR SALE ADVERTISEMENTS acceptable only in Displayed Style.

UNDISPLAYED

\$2.40 a line, minimum 3 lines. To figure advance payment count 5 average words as a line.

PROPOSALS, \$2.40 a line an insertion. BOX NUMBERS count as one line additional in undisplayed ads.

DISCOUNT of 10% if full payment is made in advance for four consecutive insertions of undisplayed ads (not including proposals).

ELECTRONIC

WAR TERMINATION INVENTORIES

WRITE OR WIRE FOR INFORMATION ON CUR
COMPLETE LINE OF SURPLUS ELECTRONIC
COMPONENTS. ALL PRICES NET F.O.B.
PASADENA, CALIFORNIA

C&H

SALES CO.

2176-E East Colorado St.
Pasadena 8, California
RYan 1-7393

2500 PSI AIR COMPRESSOR

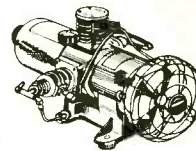

3 stage. Mfg. by
Cornelius. Model
32-R-800. Type C-2; driven by 27 V.D.C.,
21 amp motor, .6 cfm free air.

\$69.50 each

INVERTERS

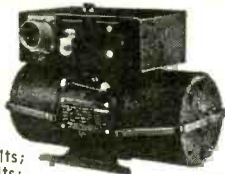

- 10042-1-A Bendix
DC Input 14 volts;
output: 115 volts;
400 cycles. 1-phase; 50 watt **\$35.00**
- 12116-2-A Bendix
Output: 115 VAC; 400 cyc; single phase; .45
amp. Input: 24 VDC, 5 amps. **\$35.00**
- 12117 Bendix
Output: 6 volts; 400 cycles, 6 volt amperes,
1 phase. Input: 24 VDC; 1 amp. **\$15.00**
- 12121 Bendix
Input: 24 volt D.C. 18 amp. 12000 r.p.m.
Output: 115 volts, 400 cycle, 3-phase. 250
volt amp, 7 pf. **\$49.50**
- 12123 Bendix
Output: 115 V; 3 phase; 400 cycle; amps.
.5; Input: 24 VDC; 12 amp. **\$49.50**
- 12126-2-A Bendix
Output: 26 volts; 3 phase; 400 cycle; 10
VA; 6 PF. Input: 27.5 volts DC; 1.25 amps. **\$24.50**
- 12130-3-B Bendix
Output: 125.5 VAC; 1.5 amps. 400 cycles
single phase, 141 VA. Input: 20-30 VDC.
18-12 amps. Voltage and frequency regu-
lated. **\$49.50**
- 12137 Bendix
Output 250 VA, 115 volts, 3 phase, 400
cycle, 1.25 amp., 0.8 pf. Input 27.5 volt
DC, 20 amp. **\$59.50**
- 12142-1-A Bendix
Output: 115 volts, 3 phase, 400 cycle, 250
VA. Input: 27.5 VDC, 22 amps. Voltage
and frequency regulated. **\$99.50**
- 12147-1 Pioneer
Output: 115 VAC, 400 cycles; single phase.
Input: 24-30 VDC; 8 amps. **Price \$39.50 each**
- 778 Bendix
Output: 115 volt, 400 cycle; 190 VA; single
phase and 26 volt, 400 cycle, 60 VA, single
phase. Input: 24 VDC. **\$37.50**
- 10285 Leland
Output: 115 volts AC; 750 VA, 3 phase, 400
cycle, .90 pf and 26 volts. 50 VA single
phase, 400 cycle, .40 pf. Input: 27.5 VDC
60 amps. cont. duty, 6000 rpm. Voltage and
frequency regulated. **\$59.50**
- 10339 Leland
Output: 115 volts; 190 VA; single phase;
400 cycle, .90 pf and 26 volts; 60 VA; 400
cycle, .40 pf. Input: 27.5 volts DC, 18
amps. cont. duty, voltage and freq. regu-
lated. **\$49.50**
- 10486 Leland
Output: 115 VAC; 400 cycles; 3-phase; 175
VA; .80 pf. Input: 27.5 DC; 12.5 amps.;
cont. duty. **\$70.00**
- 10563 Leland
Output: 115 VAC; 400 cycle; 3-phase; 115
VA; 75 pf. Input: 28.5 VAC; 12 amps. **\$35.00**
- F16 Jack & Heintz
Output: 115 volts, 400 cycle, 1 or 3 phase,
250 VA pf. 9. Input: 27.5 volts, 20 amp.
Electronic frequency and voltage regulated.
\$99.50 each
- PE109 Leland
Output: 115 VAC, 400 cyc.; single phase;
1.53 amp.; 8000 rpm. Input: 13.5 VDC; 29
amp. **\$50.00**
- PE218 Leland
Output: 115 VAC; single phase pf. 90;
380/500 cycle; 1500 VA. Input: 25-28 VDC;
92 amps.; 8000 rmps.; Exc. Volts 27.5.
-BRAND NEW **\$30.00**
- MG149F Holtzer-Cabot
Output: 26 VAC @ 250 VA; 115 V. @ 500
VA; single phase; 400 cycle. Input: 24 VDC
@ 36 amps. **\$40.00**
- MG153 Holtzer-Cabot
Input: 24 VDC; 52 amps. Output: 115 volts
-400 cycles, 3-phase, 750 VA. Voltage and
frequency regulated. **\$95.00**
- AN 3499 Eicor, Class "A"
Input: 27.5 volts at 9.2 amps. AC. Output:
15 volts, 400 cycles; 3 phase, 100 voltamp;
continuous duty. **Price \$39.50 each**

PRECISION AUTOSYNS

MFGD. BY ECLIPSE-PIONEER



- | | |
|---|---------|
| AY 200-4-B Power Transmitter | \$12.50 |
| AY 201-1-B Multi-Power Transmitter | 15.00 |
| AY 201-2-B Receiver | 15.00 |
| AY 201-3-B Generator or Control Transformer | 15.00 |
| AY 201-4-B Power Transmitter | 15.00 |
| AY 202-2-B Double Shaft Receiver | 15.00 |
| AY 202-4-B Double Shaft Power Transmitter | 15.00 |
| AY 221-3-B Sine Cosine Resolver | 12.50 |
| AY 231-3-B Differential | 9.50 |

SELSYNS- SYNCHROS



- | | |
|---|-----------|
| 1CT cont. Trans. 90/55V 60 cy. | \$37.50 |
| 1DG Diff. Gen. 90/90V 60 cy. | 37.50 |
| 1F Syn. Mtr. 115/90V 60 cy. | 37.50 |
| 1G Gen. 115V 60 cy. | 12.50 |
| 1SF Syn. Mtr. 115/90V 400 cy. | 7.50 |
| 2J1F1 Gen. 115/57.5V 400 cy. | 10.00 |
| 2J1F3 Gen. 115/57.5V 400 cy. | 7.50 |
| 2J1FA1 Gen. 115/57.5V 400 cy. | 5.00 |
| 2J1G1 57.5/57.5V 400 cy. | 7.50 |
| 2J1H1 Diff. Gen. 57 5V 400 cy. | 17.50 |
| 2J5D1 Cont. Trans. 105/55V 60 cy. | 17.50 |
| 2J5F Cont. Trans. 105/55V 60 cy. | 17.50 |
| 2J5H1 Gen. 115/105V 60 cy. | 17.50 |
| 2J15M1 Gen. 115/57.5V 400 cy. | 34.50 |
| 5CT cont. Trans. 90/55V 60 cy. | 34.50 |
| 5D D ff. Mtr. 90/90V 60 cy. | 34.50 |
| 50DG Diff. Gen. 90/90V 60 cy. | 34.50 |
| 5F Syn. Mtr. 115/90VAC 60 cy. | 42.50 |
| 5G Syn. Gen. 115/90VAC 60 cy. | 12.50 |
| 5HCT Cont. Trans. 90/55V 60 cy. | 25.00 |
| 5SDG Diff. Gen. 90/90V 400 cy. | 34.50 |
| 60G Diff. Gen. 90/90V 60 cy. | 42.50 |
| 6G Syn. Gen. 115/90VAC 60 cy. | 17.50 |
| 7G Syn. Gen. 115/90VAC 60 cy. | 15.00 |
| R110 2A Kearfott Cont. Mtr. | 15.00 |
| 115V 400 cy. | |
| R200 A Kearfott Cont. Trans. | 15.00 |
| 26'11.8V 400 cy. | |
| R210-1-A Kearfott Trans. | 20.00 |
| 26'11 8V 400 cy. | |
| R220 T-A Kearfott Receiver | 20.00 |
| 26'11.8V 400 cy. | |
| R235-1A Kearfott Resolver | 22.50 |
| 26'11 8V 400 cy. | |
| C56701 Type 11-4 Rep. 115V 60 cy. | 20.00 |
| C69405-2 Type 1-1 Transm. | 20.00 |
| 115V 60 cy. | |
| C69406 Syn. Transm. 115V 60 cy. | 20.00 |
| C69406-1 Type 11-2 Rep. 115V 60 cy. | 10.00 |
| C76156 Volt. Rec. 115V 60 cy. | 5.00 |
| C78248 Syn. Transm. 115V 60 cy. | 7.50 |
| C78249 Syn. Diff. 115V 60 cy. | 20.00 |
| C78863 Repeater 115V 60 cy. | 7.50 |
| C79331 Transm. Type 1-4 115V 60 cy. | 7.50 |
| B51 Bendix Autosyn Mtr. 22V 60 cy. | 19.50 |
| 403 Kollsman Autosyn. Mtr. 32V 60 cy. | 19.50 |
| FPE-25-11 Diehl Servo Mfr. | 15.00 |
| 75'115V 60 cy. | |
| FPE-23-1 Resolver 400 cy. | 10.00 |
| FJE-43-9 Resolver 115V 400 cy. | 10.00 |
| 999-C411 Kollsman 26V 400 cy. | 12.50 |
| 1377-0410 Kollsman 26V 400 cy. | 15.00 |
| 1515E-0410 Kollsman 26V 400 cy. | 12.50 |
| 10047-2A Bendix 26V 400 cy. | 15.00 |
| 2900 Transicoil 115V 400 cy. | 15.00 ea. |
| 15CX4a Synchro Transmitter MK
22 MOD 1 | |

DIFFERENTIAL



Size 2-11/16" long
1-11/16" dia. 1-1
reverse ratio. 1/4" shaft
on each end; one shaft
25/32" long, one shaft
15/32" long. Input
and output gear
1-23/32" dia. 53
teeth.

Stock No. 150

\$3.50 ea.

SIMPLE DIFFERENTIAL

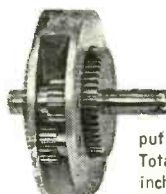

1 to 1 reverse ratio; 48
teeth on input and out-
put gear, 1-1/32 inch diameter.
Total outside diameter 1-25/32
inches. Shaft size is 1/4 inch.
One shaft is 9/16" long; other
shaft is 3/16" long. **\$5.00**

Stock No. 151

CONDENSERS

- | | |
|---|------------|
| 10 mfd. G.E. 600 VDC w/mtg brackets | \$.95 ea. |
| 8 mfd. G.E. 600 VDC | .90 ea. |
| 4 mfd. 600 VDC w/mtg brackets | .50 ea. |
| 2 mfd. 600 VDC w/mtg brackets | .35 ea. |
| Mica, .01 mfd, 8000 volts, 20 amps, Type
F3B | 2.00 ea. |

BALL DISC INTEGRATOR



Forward & Reverse 2 1/4-0-2 1/4.
Input shaft spline gear 12
teeth 9/32" dia. 3/8" long.
Output shaft 15/64" dia. x
15/32" long. Control shaft
11/32" x 3/8" long. Cast alu-
minum construction. Approx.
size 3" x 3" x 2 3/4".

No. 145
\$17.50 ea.

(All Shafts on Both Ball Bearing Supported)

SMALL DC MOTORS



- (approx. size overall 3 3/4" x 1 1/4" dia.)
- | | |
|---|-------------|
| 5067126 Delco PM, 27 VDC, 125 RPM,
Governor Controlled | \$15.00 ea. |
| 5069600 Delco PM 27.5 VDC 250 rpm | 12.50 |
| 5069230 Delco PM 27.5 VDC 145 rpm | 15.00 |
| 5068750 Delco 27.5 VDC 160 rpm w. brake | 6.50 |
| 5068571 Delco PM 27.5 VDC 10,000 rpm
1x1x2") | 5.00 |
| 5069790 Delco PM, 27 VDC, 100 RPM,
Governor Controlled | 15.00 ea. |
| 5BA10A118 GE 24 VDC 110 rpm | 10.00 |
| 5BA10AJ37 GE 27 VDC 250 rpm reversible | 10.00 |
| 5BA10AJ52 27 VDC 145 rpm reversible | 12.50 |
| 5BA10AJ50, G.E., 12 VDC, 140 R.P.M. | 15.00 |
| 206-1001 PM Planetary Gear Reduced
Motor with Magnetic Brake. Mfgd. by
Air Equipment 26 volts 600 ma 145
rpm | 17.50 |
| 5BA10FJ33, G.E., 12 VDC, 56 R.P.M.,
reversible | 15.00 |
| 806069 Oster series reversible 1/50 h.p.
10,000 rpm. 27.5 VDC 1 5/8" x 3 1/2" | 5.00 |
| C-28P-1A 27 VDC 1/100 h.p. 7,000 rpm | 3.00 |
| 7100-B-PM Hansen 24 VDC 160 rpm | 7.50 |
| SSFD-6-1 Diehl PM, 27.5 VDC 10,000 rpm 4.00
6-volt PM motor mfgd. by Hansen 5,000 rpm
1 1/4" in dia., 2" long overall | 4.00 |

SPECIAL PURPOSE TUBES

OA2 .70	4-400A 42.50	FG-57 6.50	804 7.00	5692 4.75
OA2WA 3.00	4-1000A 125.00	RK-61 2.25	805 3.00	5693 3.50
OA3 VR75 .85	4B31 20.00	RK65/5D23 7.00	807 1.20	5702 1.25
OB2 .50	4B32 7.00	FG-67 6.75	807W 1.25	5703 .75
OB2WA 2.50	4C33 100.00	HY-69 2.50	810 10.00	5704 1.15
OB3/VR90 .80	4D32 22.50	FG-81A 8.50	811 2.85	5719 1.30
OC3/VR105 .50	4E27 8.00	FG-95 13.50	812 2.50	5720 17.50
OD3/VR150 .50	4J45 35.00	100TH 6.00	813 8.75	5721 125.00
EL-C1B 1.00	4J46 35.00	102L 2.50	814 1.75	5725 2.50
EL-1C 1.50	4J61 125.00	FG-104 30.00	815 1.75	5726 1.00
1A04 .80	4PR60A 25.00	FG-105 12.50	816 1.50	5727 1.25
1B22 1.00	4X150A 18.50	121A 2.50	828 8.00	5728 7.50
1B24 5.00	4X500F 40.00	122A 2.50	829B 8.50	5734 13.25
1B35 3.25	5AP1 2.50	123A 2.50	832A 6.50	5740 75.00
1B35A 6.50	EL-5B 4.00	124A 2.50	834 5.00	5749 1.15
1B40 2.00	5BP1 2.50	FG-172 15.00	835 2.00	5750 2.00
1B59 9.50	5BP1A 7.50	FG-190 5.00	836 1.15	5751 1.85
1B63A 16.00	5BP2A 5.00	CE-203 5.00	837 1.25	5755 8.50
1D21/SN4 5.00	5C22 25.00	203A 2.50	845 2.00	5763 .85
1P21 30.00	5CP1 2.50	207 35.00	850 5.00	5783 2.50
1P22 4.00	5CP1A 7.50	211H 10.00	866A 1.25	5784 4.00
1P25A 15.00	5CP7A 8.50	CE-235A 5.00	866 JR 1.25	5796 6.50
1P28 12.50	5CP12 7.50	FG-235A 55.00	868/PJ-23 1.50	5798 12.50
1Z2 2.50	5FP14 5.00	242C 10.00	869B 50.00	5800 6.00
2AP1 2.00	5HP1 1.75	QK-243 40.00	GL-872A 2.00	5801 3.50
2AP1A 3.50	5JP1 7.50	244A 3.50	872A 1.00	5803 3.00
2BP1 3.50	5JP2A 5.00	245A 5.00	874 .50	5814A 2.00
2C36 35.00	5JP4 3.50	249B 2.50	884 .95	5814WA 3.00
2C39 4.00	5JP5A 7.50	249C 2.50	885 .65	5819 30.00
2C39A 10.00	5JP11A 7.50	250R 3.50	889RA 100.00	5820 400.00
2C40 6.50	5LP1 12.50	251A 40.00	913 17.50	5824 2.50
2C42 8.00	5LP2A 7.50	252A 2.50	917 1.40	5827 3.50
2C43 8.00	5R4GY 1.20	253A 6.00	918 1.50	5828 6.00
2C46 5.00	5R4WGY 2.75	254A 2.00	920 2.00	5829 .80
2C50 5.00	5RP1A 12.50	257A 10.00	922 1.75	5830 85.00
2C51 3.00	5RP11A 75.00	259A 10.00	923 1.25	5839 5.00
2C52 2.50	5SP1 30.00	262B 4.75	927 1.00	5840 2.85
2D21 .75	5SP7 30.00	FP-265 12.50	929 1.00	5842 12.00
2D21W .95	5UP7 12.50	267B 3.50	931A 3.75	5847 12.00
2E22 2.00	5XP1 50.00	268A 5.00	959 1.15	5854 .85
2E24 2.00	5XP11 50.00	271A 7.50	CK-1006 3.00	5881 3.25
2E26 3.25	5Y3WGT 1.00	272A 4.50	1237 3.75	5886 2.25
2J33 12.50	EL-C6J 10.00	274A 2.50	HY-1269 2.50	5894 16.00
2J51 200.00	EL-C6L 5.00	274B .50	1274 2.50	5899 3.25
2J52 50.00	6AC7W .60	275A 3.50	1603 4.00	5902 3.75
2J59 50.00	6AC7WA 4.75	276A 10.00	1614 1.50	5902A 5.00
2J61 7.50	6AG5WA 2.25	279A 150.00	1620 3.50	5910 .50
2J62 3.00	WE-6AK5 1.25	282A 3.75	1624 1.10	5915 .50
2J64 75.00	6AK5W 1.00	282B 3.75	1846 50.00	5932 3.25
2K25 12.00	6AL5W 1.00	285A 4.50	2050 1.00	5933 1.25
2K26 30.00	6AN5 2.15	286A 3.25	2050W 2.50	5948/1754 100.00
2K28 27.50	6AN5WA 4.50	287A 2.00	5528 5.00	5949/1907 75.00
2K29 35.00	6AQ5W 1.75	293A 8.00	5550 30.00	5962 3.50
2K30 75.00	6AR6 1.35	300B 7.00	5552 55.00	5963 1.25
2K33A 75.00	6AR6WA 6.00	304TH 17.50	5553/FG258 75.00	5964 1.00
2K34 85.00	6AS6 1.50	304TL 17.50	5556 10.00	5975 2.50
2K35 150.00	6AS6W 2.50	310A 3.50	5557 4.50	5977 2.50
2K41 85.00	6AS7G 2.25	311A 3.50	5558 4.50	5979 6.00
2K42 100.00	6AU6WA 1.85	313C 2.00	5559 6.50	5980 5.50
2K45 25.00	6BA6W 1.15	323A 7.50	5560 13.50	5981/5650 50.00
2K47 100.00	6BE6W 2.00	323B 3.50	5561 30.00	5993 8.00
2K48 50.00	6BL6 20.00	328A 3.50	5584 3.00	5998 4.00
2K50 100.00	6BM6 25.00	336A 3.50	5591 2.25	6005 1.75
2X2A .75	6C21 15.00	338A 3.50	5610 1.00	6012 3.50
3ABP1 50.00	6F4 2.25	339A 8.50	5632 7.50	6021A 4.00
3AP1 1.50	6J4 1.15	347A 2.50	5633 4.00	6037 40.00
3AP11A 4.50	6J4WA 2.25	350A 2.50	5634 5.00	6038 7.50
3B24 .75	6J6W .85	350B 2.50	5635 4.00	6073 1.25
3B24W 4.00	6J6WA 2.25	354A 2.25	5636 2.25	6074 2.50
3B25 4.50	6K4 2.00	355A 7.50	5637 3.00	6080 3.50
3B26 2.75	6K4A 2.50	375A 9.50	5638 2.75	6080WA 6.50
3B28 3.75	6L4 2.00	388A 1.00	5638 2.50	6087 4.00
3B29 4.50	6L6WGA 3.25	393A 3.50	5639 5.00	6096 1.25
3BP1 2.00	6L6WGB 3.25	394A 2.50	5639A 5.50	6098 6.00
EL-C3J 7.50	6Q5G 2.50	403A 1.25	5640 5.00	6100 2.00
EL-C3J/A 9.50	6S17WGT 2.00	403B 2.25	5641 3.75	6101 2.25
EL-3C 3.50	6SK7W .60	404A 12.00	5642 1.10	6130 4.25
3C23 3.50	6SL7WGT 1.00	407A 2.25	5643 3.50	6134 4.75
3C24 2.00	6SN7WGT .75	408A 1.75	5644 5.00	6136 2.25
3C30 3.00	6SU7GT 2.00	409A 4.00	5645 4.50	6137 2.00
3C33 5.00	6X4WA 2.50	417A 12.00	5546 2.50	6146 4.35
3C45 4.25	6X5WGT 1.50	418A 17.50	5647 3.50	6186 2.25
3D22 9.50	7MP7 15.00	420A 8.50	5650 50.00	6189 2.50
3E22 5.00	7YP2 50.00	421A 4.00	5651 1.20	6201 3.00
3E29 8.50	VX-10 4.00	429A 7.50	5651WA 3.00	6263 9.00
3GP1 2.00	12AT7WA 3.00	GL-434A 10.00	5654 1.20	6264 4.85
3J21 25.00	12AU7WA 2.50	450TH 40.00	5656 4.50	6328 1.85
3J31 25.00	FG-17 4.50	450TL 45.00	5663 .50	6463 3.00
3JP1 7.50	HK-24 2.00	464A 1.00	5667 100.00	6626 2.50
3JP2 2.50	HK-24G 2.00	GL-575A 10.00	5670 2.00	6627 35.00
3JP7 7.50	26C6 .50	631-P1 5.00	5670WA 3.50	6655 4.00
3JP12 7.50	26Z5W 3.00	707B 2.00	5672 1.00	8005 3.00
3KP1 7.50	FG-27A 8.00	715C 10.00	5675 8.00	8012A 3.50
3X2500A3 150.00	FG-32 4.50	719A 10.00	5676 .75	8013A 58.50
4-65A 13.50	FG-33 15.00	721B 6.85	5678 7.50	8020 1.25
4-125A 20.00	VX-33A 3.50	723A/B 6.50	5684 9.50	9001 .70
4-250A 32.50	35T 4.00	725A 2.25	5685 10.00	9002 .50
	35TG 2.00	726A 4.00	5686 2.25	9003 1.00
	VX-41 6.00	726B 8.50	5687 2.00	9005 2.50
	FP-54 75.00	750TL 35.00	5687WA 4.50	
	VX-55 2.50	802 2.00	5691 4.50	

ALL TUBES ARE NEW, INDIVIDUALLY CARTONED, FULLY GUARANTEED

western engineers

ELK GROVE, CALIFORNIA
SUPPLIERS OF TUBES SINCE 1932

Orders for less than \$10 cannot be processed

Prices are FOB shipping point

SYNCHROS TUBES LAB TEST EQUIPMENT SERVO MOTORS

ALL COMPONENTS FIRST QUALITY AND 100% GUARANTEED IMMEDIATE DELIVERY FROM STOCK Circle 410 Readers Service Card for 16 page catalog

ELECTRONIC
RESEARCH LABORATORIES
715-19 Arch St., Phila. 6, Pa. • MArket 7-6771
Cable Address: LECTRONIC, Philadelphia

U-79-U
Audio Plugs
Large Quantity available for immediate delivery
WILGREEN INDUSTRIES
99 Murray St. New York 7, N. Y.
Worth 4-2490-1-2

SEARCHLIGHT Equipment Spotting Service

This service is aimed at helping you, the reader of "SEARCHLIGHT", to locate Surplus new and used electronic equipment and components not currently advertised. (This service is for USER-BUYERS only). No charge or obligation.

How to use: Check the dealer ads to see if what you want is not currently advertised. If not, send us the specifications of the equipment and/or components wanted on the coupon below, or on your own company letter-head to:

Searchlight Equipment Spotting Service
c/o ELECTRONICS,
330 W. 42nd St. N. Y. 36, N. Y.
Your requirements will be brought promptly to the attention of the equipment dealers advertising in this section. You will receive replies directly from them.

Searchlight Equipment Spotting Service
c/o ELECTRONICS
330 W. 42nd St., N. Y. 36, N. Y.
Please help us locate the following equipment components:

NAME _____
TITLE _____
COMPANY _____
STREET _____
CITY _____

11/1/57



WE BUY

- ARC-3
- ARN-6
- ART-13
- AS-313
- LOOPS
- BC-788C

TEST EQUIPMENT
Top Prices Paid
Writes today!

Now available
NEW FREE SALES CATALOG 116

It is loaded with bargains in ALL departments:

- | | |
|--------------|-------------------|
| Tubes | Test Equip. |
| Meters | Mikes |
| Headsets | Transmitters |
| Receivers | Capacitors |
| Transformers | Etc., etc., etc., |

SEND FOR CATALOG 116 TODAY!
You'll be glad you did!

ARROW SALES, INC. Dept. E.

7460 Varma Ave., No. Hollywood, Cal.

a TERRIFIC BARGAIN in a

SOLA CONSTANT-VOLTAGE TRANSFORMER

Ends fluctuating line voltage!

Big Discount Off . . .

the factory price at a 1-input 2,000 VA unit! And here's another bonus! This Air Forces 2,000 VA over-stock, Sola Cat. No. 30768, has 4 inputs! 50-125 V., 190-250 V., 60 cy. or 50 cy. Isolated secondary is constant 115.0 V. - 1% from no-load to full-load of 17.4 amp. So, if you choose, use it as a 220-115 V. step-down. And slash \$97.50 off the factory 1-input price!



\$147.50

Brand new in original wood box. 4 cu. ft. Ship. wt. 254 lbs. F.O.B. Pasco.
THE M. R. COMPANY
Beverly Hills, Calif.
P. O. Box 1220-B

this Searchlight Section of ELECTRONICS

is an index of reliable sources for Used and Surplus Equipment now available. Consult the Searchlight Section in regular monthly issues for later offerings.

If you don't see what you want—ask for it. Ask the advertisers. They are constantly adding to their stocks and may have acquired just what you need. And, when you have special items to dispose of, use the Searchlight Section of Electronics to help you locate buyers. . . . Send a list of your equipment and we will gladly give full information as to space and rates.

Classified Advertising Division

ELECTRONICS

P. O. Box 12 • New York 36, N. Y.

NEW YORK'S RADIO TUBE EXCHANGE

100
1,000
100,000
1,000,000
DECEIVING, TRANSMITTING & SPECIAL ELECTRONIC TUBES & TRANSISTORS

Type	Price	Type	Price	Type	Price
OA2	.65	3FP7A	2.00	718B	3.00
OB2	.95	3Z40	25.00	719C	31.00
OB3	.60	3X1L	45.00	71A	.35
OC3/VR90	.85	3K22	150.00	719A	40.00
OC2/VR105	.50	3K23	150.00	720A V-EY	50.00
OD3/VR160	.45	3K30	95.00	721A	.75
1B22	1.25	3PB1A	3.50	721B	7.00
1B23	2.75	4B23	5.00	722A	.75
1B24	5.50	4B24	4.50	723A	4.00
1B24A	12.50	4B26	2.50	723A/B	7.50
1B26	1.25	4B30	20.00	725A	3.00
1B27	10.00	4C27/CV92	9.00	728A	5.00
1B29	2.50	4C28	19.75	728B	14.00
1B35	3.35	4E23	8.00	720C	33.00
1B36	5.75	4J30	40.00	730A	5.00
1B37	6.00	4J31	150.00	801A	.25
1B42	4.50	4K23	45.00	801B	1.75
1B44	15.00	4J34	35.00	804	8.00
1B45	22.50	4J42	25.00	805	4.50
1B47	7.50	4K24	95.00	806	1.10
1B68	6.75	4J52	50.00	807W/6983	1.50
1B88	60.00	4X150A	19.00	808	1.00
1B92	5.00	5A1P	20.00	809	2.70
1B93A	19.00	5A1P11	20.00	810	10.00
1N21	.50	5A1P	2.95	811A	3.50
1N21B	.50	5A1P11	2.95	811B	3.50
1N23	.50	5CP1	1.75	814	2.25
1N23B	.90	5CP1A	8.50	815	1.50
1N25	2.50	5D10	2.00	819	8.50
1N26	3.50	5CP7A	7.50	828	8.00
1N32	9.00	5CP11A	9.50	829	5.00
1N38A	3.35	5D12	8.00	830	3.00
1P28	30.00	5G22	17.00	830B	.45
1P28	45.00	5D21	5.00	832	4.00
1P28	8.50	5J10	8.50	832A	6.00
1P30	1.25	5J11	5.00	833A	33.00
2BP1	5.00	5J12	5.00	834	5.00
2C8A/RK34	2.50	5J11A	9.50	836	1.00
2C8B	2.00	5J29	4.00	838	1.70
2C89	5.50	5D30	5.00	840	1.25
2C99A	10.00	5J33	4.00	843	.35
2C40	6.50	5M1P	2.50	845	20.00
2C43	8.00	5B47	2.00	849	6.00
2C45	4.50	5R4GY	1.30	851	6.00
2C46	5.00	5R4WGY	3.00	852	4.00
2C60	6.00	5R11A	13.50	861	10.00
2C65	3.00	5R11A	1.00	865	.40
2C65	2.50	6A07W	1.00	868	1.20
2C65	9.75	6A07W	1.00	868A	18.00
2D21W	4.00	6A15W	70	872A	1.00
2J21	4.00	6A15W	25.00	876	.70
2J22	12.25	6J8W	7.50	878	.50
2J32	11.00	6K57G	2.00	917	1.30
2J48	4.50	6S07GT	2.00	917	1.30
2J48	12.50	7B1P	4.50	919	1.70
2J36	20.00	12A7W	2.50	954	.35
2J39	25.00	12A7WA	2.50	954	.35
2J41	125.00	12A7Y	1.50	966	.35
2J42	60.00	12DE7A	20.00	957	.35
2J48	10.00	15B	1.20	958A	1.25
2J49	27.50	15E	1.20	959	1.25
2J50	35.00	15R	1.35	11NE16	.35
2J51	20.00	15R	1.35	E1148	.35
2J56	35.00	26A7GT	3.00	1280	.90
2J61	12.00	85T	6.00	E103564	75.00
2J61A	30.00	85T	6.00	E103564	75.00
2J62	5.00	HK-64	3.50	1012	1.50
2J62A	50.00	PG-67	9.50	1013	1.25
2K22	13.50	RK-60/1641	2.25	1851	1.75
2K22	10.00	RK-61	20.00	1019	.45
2K25	12.00	RK-61	20.00	1022	1.50
2K26	32.00	HK-65	1.00	1625	.35
2K28	37.00	HK-65/D23	7.50	1626	1.80
2K29	25.00	HK-65/D23	7.50	1626	1.80
2K33	100.00	HK-69	2.25	1851	1.75
2K33A	50.00	RK-72	.35	2050	1.50
2K33B	150.00	RK-73	.35	2061	1.00
2K39	100.00	H F05	16.50		
2K41	90.00	H F100	4.00		
2K44	125.00	100TH	6.50		
2K45	32.50	21A7T4C	3.50		
2K46	199.50	260TH	21.00		
2K47	100.00	WE-274B	18.00		
2K48	50.00	301L	18.00		
2K50	140.00	307A/RK75	.60	5820	475.00
2K54	15.00	V7327A	3.50	5823	450.00
2K55	14.00	30B	2.00	8012	2.00
2K56	50.00	39A	2.50	8012A	2.50
2V3G	.80	WE-419A	25.00	8013	3.00
2X3	.30	WE-417A	3.50	8014A	3.50
2X2A	1.00	WE-417A	12.50	8019	1.75
3A4	.50	442B	1.25	8028	3.75
3B1	1.50	CL-502A	1.25	8028	3.75
3B22	1.35	559	.40	P8365	96.00
3B24	1.35	2599	16.00	9002	1.52
3C22	59.50	HY-615	.45	9002	1.52
3C23	3.95	WE-701A	1.85	9003	1.25
3C24/24G	2.00	WE-703A	1.00	9004	.35
3C27	1.95	WE-704A	.60	9002	2.75
3C31/C1B	1.00	WE-705A	.75	9006	.25
3C32	6.50	707A	2.00		
3C32A	6.50	707B	2.50		
3DP11A	7.00	714A	10.00		
3D21A	3.00	718A	1.00		

OTHER TEST EQUIPMENT USED CHECKED OUT, SURPLUS

- TSK1/SE K Band Spectrum Analyzer
- TS3A/AP Frequency and power meter S Band
- RF4A/AP Phantom Target S Band
- TS12/AP VSWR Test Set for X Band
- TS13/AP X Band Signal Generator
- TS14/AP Signal Generator

Thousands of other tubes

NEW UNUSED SURPLUS STANDARD LABORATORY RECEIVERS

- AN/APR4 complete with five tuning units 38 to 4000 m.c.
- AN/APR5A, 3000-6000 m.c.
- AN/APR10, 2000-4400 m.c.



NEW TS-147 X TEST SET HARD-TO-GET X-BAND SIGNAL GENERATOR

Now Available
Test Set TS 147 UP is a portable Microwave Signal Generator designed for testing and adjusting beacon equipment and radar systems which operate within the frequency range of 8500 MC to 9600 MC.

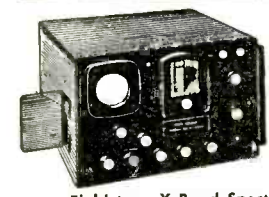

NEW Microwave Test Equipment TS148/UP SPECTRUM ANALYZER

Field type X Band Spectrum Analyzer, Band 8430-9580 Megacycles.
Will Check Frequency and Operation of various X Band equipment such as Radar Magnetrons, Klystrons, TR Boxes. It will also measure pulse width, c-w spectrum width and Q or resonant cavities. Will also check frequency of signal generators in the X band. Can also be used as frequency modulated Signal Generator etc. Available new complete with all accessories, in carrying case.

New Unused Surplus TS 259 K Band 23400-24500 Megacycles Signal Generator

SPECIAL! 5,000 V. POWER SUPPLY For IP25 Infrared Converter from 3 V. Battery Source. NEW, Complete with RCA 1654 Tube. \$9.90

OTHER TEST EQUIPMENT USED CHECKED OUT, SURPLUS

- TS33/AP X Band Power and Frequency Meter
- TS34/AP Western Electric Synchroscope
- T35/AP X Band Signal Generator
- TS36/AP X Band Power Meter I-96A Signal Generator
- TS45 X Band Signal Generator
- TS47/AP 400-400 MC Signal Generator
- TS09/AP Frequency Meter 400-1000MC
- TS100 Scope
- TS102A/AP Range Calibrator
- TS108 Power Load
- TS110/AP S Band Echo Box
- TS125/AP S Band Power Meter
- TS126/AP Synchroscope
- TS147 X Band Signal Generator
- TS174/U Signal Generator
- TS175/U Signal Generator
- TS182
- TS226 Power Meter
- TS239A-TS239C Synchroscope
- TS251 TS258
- TS270 S Band Echo Box
- TF890/I X Band Spectrum Analyzer
- 834 General Radio Frequency Meter
- SURPLUS EQUIPMENT
- S04 Radar, Complete
- APA10 Oscilloscope and panoramic receiver
- APA38 Panoramic Receiver
- APS 3 and APS 4 Radar
- APR4 Receiver and Tuning Units
- APR5A Microwave Receiver
- APT2-APT5 Radar Jamming Transmitter

MINIMUM ORDER, \$25.00

SPECIAL
Thousands of tubes available at special prices

PARTIAL LIST			
2AP1	646	307A	5691
2K27	6K8G	274A	5692
4C28	6AR6	274B	5693
5A6	5R4GY	252A	5699
5W4	5W4GT	328A	5814
4J52	0Z4A	357A	9001
2A4G	6C21	450TH	9002
6J5GT	267	450TL	9003
	89	— ANY OTHER TYPES	



Phone: ORegon 4-7070

LIBERTY ELECTRONICS, INC.

119 PRINCE ST.
NEW YORK 12, N. Y.
Cables: TELSERUP

TRANSMITTERS • RECEIVERS • RADAR

FREQUENCY SHIFT KEYING and PHOTO TRANSMISSION

Model TEG transmitter—frequency range: 200 to 18,000 kcs. crystal controlled; emission A₁A₂A₃; 10 preset channels; frequency shift keying up to 600 wpm; power output, 100 watts; input voltage is 115 v. 1 ϕ , 60-60 cps. Set consists of transmitter, 2 antenna tuners, terminal, 2 transmitters controls, and 2 power transformers.—Mfr: RCA.

SCR-399-499 RADIO STATION—2-18 mcs., watts, phone and cw. Supplied as completely mobile unit or fixed ground station complete with receivers, test equipment, cables and accessories for 110 volt ac operation.

TBN TRANSMITTER—200—3000 kcs, 1000 watts, phone and cw. Used as fixed station or aboard ship; extremely rugged; 220 or 440 volt ac. input.

TDQ UHF TRANSMITTER—100—156 mcs, 45 watts A₂ and A₃, 4-xtal. controlled, channels.

TDZ UHF TRANSMITTER—225—400 mcs, 30 watts, phone 10-preset channels, dial selection, marine use.

TBM HF TRANSMITTER—2.0—18.1 mcs, 350 watts A₂, 500 watts A₁, dc or ac operation.

Also, TDE, TED, TBL, TAJ, TBK, TCS, TCR, TCP, TCE, etc. and great stocks of spare parts

SA-2-RADAR. Used for air traffic control, tracking and search, both land-based and ship-borne. 5 microsec. pulse., PPI indication, operates at 200 mcs, peak power of 150 KW. Input 110/120 volts a.c. 4 complete installations in stock.

TAJ TRANSMITTER—200—550 kcs., 500 watts cw, dc or ac operation. Modulator can be supplied to give 350 watts phone.

We Have Equipment in Quantity:

400 Sets SCR 510 and 610	100 Sets SCR 808-828
250 Sets SCR 508-528	50 Sets TCS
250 Sets SCR 608-628	200 Sets BD-71, 72 Switchboards

AND OTHERS

WILL ACCEPT BEST OFFER FOR 100 SETS SCR. 284

• TEST EQUIPMENT •

Hundreds of different types of test equipment, military as well as commercial types. Write for new catalog on your letterhead.

TS-3A/AP—"S" Band Power Meter and Signal Generator\$97.50
 TS-10/AP—Altimeter Test Set\$27.50
 TS-12/AP—Standing Wave Indicator "X" Band Write
 TS-13AP-X BAND RADAR TEST SET—Measures power, freq. signal-to-noise ratio, I.F. Band-pass, etc. Input—115/1/60—300
 TS-15/AP—Fluxmeter, Direct Reading\$69.50
 TS-34/AP—Oscilloscope, Portable, with 5, 50 and 250 Micro-second Start-Stop Special \$119.00
 TS-35A/AP—X Band Signal Generator and Power Meter. Input—110/1/50—1200 cps. Can generate and measure i/f power. New\$175.00
 TS-36/AP—Power Meter 8700 to 9500 mcs. 0.1 watt to 1 Watt in Input\$125.00
 TS-56/AP—Slotted Line, 500-675 mcs. Write
 TS-69/AP—Freq. Meter, 400 to 1000 mcs.\$69.50

TS-70/AP—R. F. Wattmeter, 200-500 mcs. Write
 TS-74/UPM—Dummy Load, "S" Band, 50 & 72 ohm input\$95.00
 TS-89/AP—Voltage Divider, Capacitive\$49.50
 TS-98/AP—Voltage Divider, Resistive 800 ohms imp. Ratio 22:1 (app.)\$27.50
 TS-100/AP—TEST SCOPE, type A, R, J & X indications, gated & ungated sweep, Int. or Ext. trigger.
 TS-110/AP—Hand Tuned Echo Box, 2400-2700 mcs; cw, mew, or Pulsed; 50 ohms impedance; Ring-time 2.5 miles; Accuracy ± 3.5 mcs. With Accessories, New\$75.00
 TS-115/AP—Signal Generator, 2700-2900 mcs. Variable Pulse Width, Rate and Delay, 50 ohms imp. Write
 TS-170/ARN-5—Test Set for ARN-5 Write

• Design, Modification, Production and Testing of Communications and Radar Equipment



COMPASS ELECTRONICS SUPPLY

A DIVISION OF COMPASS COMMUNICATIONS CORP.

75 VARICK STREET CANAL 6-7455 NEW YORK 13, N. Y.
 CABLE ADDRESS: COMPRADIO, N. Y.

BEARINGS —

Miniatures; Precision; Stainless Steel; Special Sizes, Tolerance & Construction.

RAWAY BEARING CO.

4-8 Forsythe St. Walker 5-8150 N. Y. C. 2, N. Y.

WAVEGUIDE

RG-48-U 14 ft. lengths
 \$25.00 per length
 Crating extra in less than 4 lengths
 FOB New Orleans

FREELAND PRODUCTS CO.

706 Dryades St. New Orleans 12, La.

FOR RATES OR INFORMATION

About Classified Advertising,

Contact

The McGraw-Hill
Office Nearest You.

ATLANTA, 3
1301 Rhodes-Haverty Bldg.
Jackson 3-6951
R. POWELL

BOSTON, 16
350 Park Square
Hubbard 2-7160
J. WARTH

CHICAGO, 11
520 No. Michigan Ave.
Mohawk 4-5800
W. HIGGINS

CINCINNATI, 37
2005 Seymour Ave.
Elmhurst 1-4150
F. ROBERTS

CLEVELAND, 15
1510 Hanna Bldg.
Superior 1-7000
W. SULLIVAN

DALLAS, 2
901 Vaughan Bldg.
Riverside 7-5117
G. MILLER

DETROIT, 26
856 Penobscot Bldg.
Woodward 2-1793
W. STONE

LOS ANGELES, 17
1125 W. 6 St.
Madison 6-9351
C. DYSINGER • D. McMILLAN

NEW YORK, 36
500 Fifth Ave.
Oxford 5-5959
S. HENRY • D. COSTER • R. LAWLESS

PHILADELPHIA, 3
17th & Sansom St.
Rittenhouse 6-0670
H. BOZARTH • R. EDSALL

ST. LOUIS, 8
3615 Olive St.
Jefferson 5-4867
F. HOLLAND

SAN FRANCISCO, 4
68 Post St.
Douglas 2-4600
R. ALCORN

LEGRI S CO

"KING OF THE RESISTORS"
ANY TYPES — ANY VALUES

→ FROM OUR OWN STOCK →

391 Riverdale Ave. Yonkers 5, N. Y.

A-B Brand



KOILED CORDS 3 wires \$1.26
22 inches long stretches to 9 ft.

Only a few more left
GONIOMETER
TYPE CFT-47372 — 250 to 1500 K.C.

nightlighter — Automatic lightswitch. Darkness throws the switch—turns lights on at dusk... off at dawn. Pools at burglars who watch for signs of an empty house. Same as your city buys for \$45 on top of street lamp posts. **\$15.95**



TELECHRON Motors
1 RPM ... \$3.95 | 3.6 RPM ... \$3.15
2 RPM ... 2.90 | 60 RPM ... 4.85
3 RPM ... 3.90 | 3 RPHr ... 2.35
4 RPM ... 3.90 | 1 RP 2Hr ... 2.80
1 RPM—50 Cycles, \$1.85
Laboratory Special 1 of Each Motor \$25

PLEASE INCLUDE POSTAGE

BLAN
EST. 1923

64 U Dey St.
New York 7
N. Y.

D-E-L-A-Y-E-D LIGHT SWITCH A-C-T-I-O-N

Shuts light off automatically almost a minute later. Keeps porch or garage light on after you shut it off. **\$3.50**
DEALERS WRITE FOR PRICES.

6 Watt Most POWERFUL
TELECHRON MOTOR
110 V., 60 Cy
1 RPM 6.50



HAYDON TIMING MOTORS



1 RPM 110v 60cy 2.60
1 RPM 230v 60cy 1.00
2 RPM 230v 60cy 1.00
30 RPM 110v 60cy 2.60
450 RPM, yes 450 RPM 1.30
HANSEN Synchron 4 RPM 4.24
CRAMER 4 RPM 4.65

DIEHL or DELCO

P. M. motors.
Made for 24 volts.
Will work at lower speed at 12v. or 6v Battery or Rectifier. Size 1" x 1" x 2". **\$3.75**



COMMUNICATIONS EQUIPMENT & TEST EQUIPMENT

SEND US YOUR LIST OF REQUIREMENTS
ALL THE BEST & FINEST AT LOW PRICES
Also Maintenance Manual AN/ARC-27 1953 Revision
MAIL, WIRE OR TELEPHONE FOR QUOTE

MONTGOMERY EQUIPMENT CO.

14315 BESSEMER ST. VAN NUYS, CALIFORNIA
TEL: State 6-4657 Telegraph YHV Van Nuys

McGRAW-HILL BOOKS

FOR YOUR READY-REFERENCE LIBRARY

RELIABILITY FACTORS FOR GROUND ELECTRONIC EQUIPMENT

Methods and working data to help designers build greater reliability into military electronic equipment. Pinpoints causes of poor reliability. Discusses electrical and mechanical factors, human engineering, and components. Gives results of failed-parts studies. Edited by Keith Henney, 280 pp., 196 illus., \$8.50

ELECTRONIC ENGINEERING

Techniques of circuit analysis for radar, television, electronic control, instrumentation, and computers. Gives alternate methods for many circuits, and provides means for combining circuits of different types. Examples relate techniques to practice. Discusses solid state theory, and transistors as circuit elements. By Samuel Seely, Prof. & Chrmn., Dept. of Elec. Engrg., Syracuse U. 525 pp., 782 illus., \$8.00

RANDOM PROCESSES IN AUTOMATIC CONTROL

Presents theory and practical techniques for analyzing linear control systems subjected to random inputs. Treats concepts of probability and random time functions in detail. Develops techniques for designing systems containing constant and time-varying components. Provides computational methods for use on computers. By J. H. Laning, Jr., and R. H. Battin, Instrument Lab., Mass., Inst. of Tech., 429 pp., illus., \$10.00

PROFESSIONAL ENGINEER'S EXAMINATION QUESTIONS and ANSWERS

Over 500 questions and complete answers to help engineers pass state license examination. Covers mechanical, electrical, civil, and chemical engineering, and includes engineering economics and land surveying. Latest questions—suitable for all states. Author has worked on New Jersey examination preparation for 19 years. By William S. Lalonde, Jr., 462 pages, 234 illustrations, \$6.50.

These "Searchlight" advertisements

are live opportunities in the Electronic field.

Each announcement represents a current Want or Offering of an organization or individual in the field. Some have money-saving possibilities, others are opportunities for more business; many offer equipment—used or surplus new.

"Searchlight" advertisements are constantly changing. New opportunities are constantly finding their way into this great Want medium, each issue. Regular reading of the "Searchlight" pages can be as important to you as reading the editorial sections; Editorial matter is news of the industry; Advertising is NEWS OF OPPORTUNITIES offered in the Industry.

for EVERY business WANT
"Think SEARCHLIGHT first"

THE MIGHTY FORCE OF RESEARCH

FORTUNE Magazine editors tell how 4 billion dollars for research is opening new business opportunities. Reveals who does research, how it is carried out, what is accomplished and what it means to you. By Editors of FORTUNE. 308 pp., 21 illus., \$4.00

10 DAYS' FREE TRIAL

McGraw-Hill Book Co., Inc., Dept. FL-11-1
327 West 41st St., N. Y. 36, N. Y.

Send me book(s) checked below for 10 days' examination on approval. In 10 days I will remit for book(s) I keep, plus few cents for delivery costs, and return unwanted book(s) postpaid. (We pay delivery costs if you remit with this coupon—same return privilege.)

- Henney—Reliability Factors for Ground Electronic Equipment—\$8.50
- Seely—Electronic Engineering—\$8.00
- Laning & Battin—Random Processes In Automatic Control—\$10.00
- Lalonde—Professional Engineer's Examination Q & A—\$6.50
- FORTUNE—The Mighty Force of Research—\$4.00

(PRINT)

Name

Address

City Zone ... State.....

Company

Position

For price and terms outside U.S. write McGraw-Hill Int'l., N.Y.C. FL-11-1

SCR 584

RADAR TRAILER

IN STOCK AS NEW—COMPLETE
FULLY EQUIPPED. 10 CM.
SEARCH AND TRACK. PPI.

A Rare Opportunity. Call Us

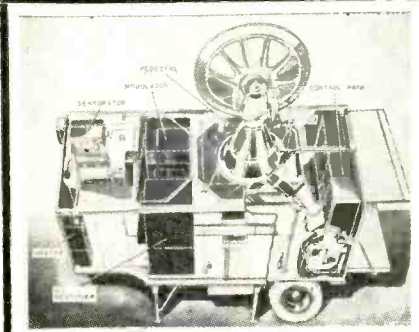

RADIO-RESEARCH INSTRUMENT Co.
550 - 5 Ave., N. Y. 36, N. Y. Tel: JU 6-4691
PAUL J. PLISHNER

WANTED!

VRC
PRC
TRC
&
GRC
Equip.



We also need ART-13 BC-224
BC-348, APN-9. What else have you?
J. J. CANDEE CO. Dept. E.
4002 W. Burbank Blvd., Burbank, Calif.
Phone: VICTORIA 9-2411

ART-13 APR-4 BC-348

BC-221, BC-342, BC-312, ARC-1, ARC-3,
DY-17, Teletype Printers, Boehme Keyers,
BC-610E

ALLTRONICS-HOWARD CO.
Box 19, Boston 1, Mass. (Richmond 2-0048)

GENUINE OAK WOOD

Antique TELEPHONES!

As is \$9.00 complete. Tested working
order \$12.00. Shipments FOB
Simpson, Pa. Write for free list.
TELEPHONE ENGINEERING CO.
Dept. E-11 Simpson, Pa.



IF THERE IS
Anything you want

that other readers of this paper can
supply

OR—

**Something you
don't want**

that other readers can use, adver-
tise it in the

Searchlight Section

SPECIAL OFFERING

TUBES

25,000-VR150	.27	MOST ARE JAN BOXED		1,000-6J4WA	1.00
15,000-2C4 2 1/2 V. gas thyatron tube	.50	500-5AP1	3.00	200-2C43	7.00
100,000-1U4	.30	2,000-5CP1	3.00	2,000-RK73	.20
50,000-6J4	.40	200-861	5.00	1,000-843	.15
50,000-6BA6	.35	200-851	5.00	1,000-865	.15
50,000-12AT7	.55	2,000-371B	.50	500-2E29	.50
10,000-956	.20	2,000-826	.35	1,000-7AG7	.55
2,000-805	2.50	2,000-6107/BS212	1.00	2,000-12KAGT	.25
1,000-838	.20	Anton Integrated.	1.00	1,000-12K8 metal	.35
10,000-1625	.20	2,000-6108/BS213	1.00	500-6SN7WGT	.75
50,000-1626	.05	Anton Integrated.	1.00	600-REL36	.30
10,000-1632	.20	2,000-958A	.20	1,000-902PI	1.00
2,000-1960	.20	2,000-26D6	.50	10,000-954	.10
2,000-5676	.50	10,000-6SG7GT	.20	10,000-955	.25
5,000-5654/6AKSW	1.30	50,000-6U7G	.10	10,000-957	.25
2,000-5841	1.25	10,000-6J7G	.15	100-Magnatron 5J26 orig. carton	150.00
1,000-CK1026	1.25	10,000-6K7G	.10	5-Magnatron QK264 orig. case	750.00
500-533AX	1.25	5,000-VT67 (30 special)	.10	400-450TH orig. Omac	35.00
1,500-5829WA	2.00	5,000-VT25A (10 special)	.15	1,000-837	.80
500-6111	2.50	2,000-2C34	.15	15-2,500-BACW	.55
200-5896	2.50	50,000-1N22 Diode Ind. Box	.07	20,000-6SD7GT	.17
100-5647	2.50	25,000-1N23 Ind. Box	.15	5,000-6SN7	.50
1,100-5977	2.00	2,000-WL1B32/532A	.15		
500-2C39A	7.50	100-5CP7A	4.00		

50,000-1/2 Mg. vol. control 3/4" dia. screwdriver shaft
\$50.00 per thousand

RESISTORS

HAVE ON HAND 5 MILLION RESISTORS,
3 million micas, 1,500,000 ceramics CHEAP

Silver ceramic trimmers
types TS2A 1 1/2 to 4 1/2, 3/13, 4/30, 7-45, have 20,000 of each
\$150 per M

1,000 relays 115VAC double pole single throw 30 AMP. height
6104/20A Leach \$4.00
1,000 2 1/2 round 0 to 5 mills meters ind. boxed, black scale full def.
\$2.50

Geiger Counter radiation detector
500 type WF10A list \$119.50
500 type WF12A list \$149.50
ind. boxed guaranteed mfg. by largest mfg. in world
50,000 Fire Chief of POF dry chemical fire extinguishers
40¢ ea. in quantity only

Johnson 829B sockets 122/101 \$1.00
2,000 UNICITE cinch 829B socket 75¢
500 Circuit breaker switch cat. no. AM10510M6 2 Amps. 115 VAC
curve 3 H. P. \$2.00
250 Crouse-Hinds obstruction light, red—EOL type, waterproof, ideal
for airport use, industrial fence lighting, outdoor waterproof, agal
socket. Cost \$12.50 ind. box \$4.00
10,000 telephone type 28V relays ind. box—all types of contacts avail-
able \$35 per hundred.

Have 4,000-10MFD-600V-CAT25F339 ceramic ins. with brackets \$1.05
10,000-2MFD-600V-Bathtub side terminals type DYR cans... 35¢
50,000-1MFD-600V-CP69 rect. mounting bracket, bottom but ter-
minals 12¢
50,000-2000MFD-15VDC electrolytic, alum.—can plug in for octal
socket 30¢
100,000-35-35-350V electrolytic, alum. can plug in for octal socket. 15¢
10,000-Pyramid metalized MPDKR 1.5/8 8 MFD 150V.D.C. 225VTDC
standard bathtub container, side terminals, type DYR can... 50¢
5,000-Hammerstund variable cap. .0001 large size trans. type. ceramic
insulators 2.500 volt 23 plates large spacing \$1.25

DISCOPHONE SALES CO, INC

35 Vestry Street New York 13, NY WOrth 6-0512

Wire Or Call Collect — Samples On Request

"TAB" THAT'S A BUY



450 MA CHOKE S3 @ W.E. Mfg. for U.S. Navy... 450ma/3kV/27 ohms hermetic Sealed & Cased...

TP502/6500VCT @ 600ma/WST/USN... TP503/540VCT @ 30ma/6.3V @ 2A... TP504/300VCT @ 100ma/3.15V @ 2A...

NEW SILICON "SILTAB" JUNCTION HIGH TEMPERATURE RECTIFIERS OPERATION TO 190°C, HIGH POWER & SMALL IN SIZE, LO-VOLTAGE DROP, HI-EFFICIENCY

Table with columns for MAX DC AMPS, VAC, and VDC for various bridge types (Half-Wave, Full Wave, F.W. Center-Tap, Half-Wave 3φ, Half-Wave 6φ, F.W. 6φ Bridge).

New Variable Voltage X-forms SUPERIOR-GR-STACO

Table listing various transformer models and their specifications, including output voltages and power ratings.

New "TESKEL" SELENIUM RECTIFIERS to Your Specs Any Current. Quick Deliveries! Write for Quantity Prices. Specials in 24 hours!!!

Table for TESKEL Selenium Rectifiers showing specifications for different bridge types and current ratings.

PRECISION POTENTIOMETERS HELIPOT, MULTIPOT Ten Turn... TIC & Frchl one rev-10KΩ... Micropot 9015/0.1% LinZB...

SI MINIATURE FAN BLOWER COOL THAT TUBE EQUIPMENT... DC MINIFAN 12 to 28VDC... Deter Miniature 400cyl Blower...

"TEK-AP" TABPAKS! High Current Power Supplies One Year Guarantee... Variable 0-28 VDC. Completely built. Ready to go.

WRITE FOR INDUSTRIAL CATALOG NEW G.E. PHONO CARTRIDGES

WRITE FOR HI-FI CATALOG Guaranteed Phono Replacement Needles

"TABTRON" Rectifier X-forms Sec'd Volts (DUAL): 0-9-15-28-40-9-15-18 Series...

4G063/LP or 4G063/78 Diamond... 4G050/LP & 78 Sapphire... 4G053/LP & 78 Diamonds... 4G052/LP & 78 Diamond & Sap...

STEVENS ARNOLD PRECISION DC-AC CHOPPER TYPE CH365 SPDT/COIL 28VDC/800 Ω IMP... 60Cys/830 Ω 400Cys/1100 Ω. Use as Chopper Reg 220 Ω SPECIAL.

"TABTRON" Rectifier Chokes CR6001/ 1 Amp/0.1 HY/1.4 Ohm... CE156M 6000MFD 15V... CE502M 2000MFD 50V...

SINCE 1945 CERTIFIED TUBE TESTING AGEING & PRESELECT FACILITIES WRITE!

"TAB" TESTED INSPECTED GUARANTEED!!! WRITE FOR COMPLETE TUBE LIST

New 115 V AUTOFORMERS For 220V/60cy Input. To 110-120V or Step up. With Cord Plug & Receptacle.

Table listing vacuum tube types and their prices, such as 6AG5, 6AR5, 6BE6, etc.

Table listing vacuum tube types and their prices, such as 6X4, 6X5, 6X6, etc.

Consisting of Transformer & Full Wave Bridge Rectifier unit and fused outlet pilot light & ventilated grill & chassis or cabinet. Ready to deliver constant 125 W DC Power. 1 yr. Gtd. Input 115VAC/60cy, 220V or 3φ. To order.

Table listing vacuum tube types and their prices, such as 6SL7, 6SN7, 6SQ7, etc.

Table listing vacuum tube types and their prices, such as 6AV6, 6BE6, 6BE7, etc.

New Isolation & Control Transformers Indoor Power Type Elec./Static-Shielded Primary 115V/230V & Secondary 1.5/230V 1φ 60 cys. Also 230/150 V Same Price.

Table listing vacuum tube types and their prices, such as 10Y, 12AT6, 12AU6, etc.

Table listing vacuum tube types and their prices, such as 12AX7, 12AY7, 12BE6, etc.

New 5-Way Binding "TEK-AP" POSTS Similar to Superior DF30, takes plugs, tips, fuse wire. 1/16" to 1/4" diams.

NEW "TABTRON" 400-II/60WS \$25 Assembled & ready to use SUPER CIRCUIT inbuilt AC & Batteries...

12 Amp Battery Eliminator, Charger, Modem RR, Filter Aircraft, Marine or any DC Rectifier. 240V V.A. Demand far. Cont. Service and up to 20 hrs. Intermittent. 115VAC/60cyl. 150W ripple. Mod. 1212V/12AC \$33.00

NEW VARIABLE 0 to 6 & 12V. SUPPLIES 12 Amp Battery Eliminator, Charger, Modem RR, Filter Aircraft, Marine or any DC Rectifier. 240V V.A. Demand far. Cont. Service and up to 20 hrs. Intermittent. 115VAC/60cyl. 150W ripple. Mod. 1212V/12AC \$33.00

THAT'S "TAB" THAT'S A BUY. Dept. IIE7 111 Liberty St., New York 6, N. Y. U. S. A. PH. RECTOR 2-6245 CABLE: "TABPARTS"

Money Back Guarantee \$5 min. Order FOB N. Y. C. And shpg. charges or for COD 25% Dep. Prices Subject to Change Without Notice. All Items Subject to Inspection w/pay All Shpg.

INDEX TO ADVERTISERS

A C Electronics Division.....	323	Century Electronics & Instruments, Inc.	334
Aco Electronics Associates, Inc.....	278	Chatham Electronics Div. of Tung-Sol Electric, Inc.	99
Acheson Colloids Co.	116	Chicago Aerial Industries, Inc.....	264
Acton Laboratories, Inc.	378	Chicago Standard Transformer Corp.....	288
Admiral Corp.	36	Chicago Telephone Supply Corp.....	41
Aeronautical Communications Equipment, Inc.	54	Christie Electric Corp.	369
Aerovox Corp.	225	Cinch Mfg. Corp.	191
Airpax Products Co.	197	City of Jacksonville	242
Alford Mfg. Co., Inc.	306	Clarostat Mfg. Corp.	73
Allegheny Ludlum Steel Corp.....	40	Cohn Corp., Sigmund	338
Allen-Bradley Co.	108	Coleman Engineering Co., Inc.....	345
Allied Plastics Supply Corp.....	72	Communication Accessories Co.	251
Allies Products Corporation	329	Computer Instruments Corp.	347
Alpha Metals, Inc.	380	Computer-Measurements Corp.	365
Alpha Wire Corp.	324	Connecticut Hard Rubber Co.....	418
American Lava Corporation	229	Consolidated Electrodynamics Corp.	205
American Machine & Foundry Co.....	86	Constantin & Co., L. L.	121
American Television & Radio Co.....	202	Continental-Diamond Fibre Subsidiary of the Budd Company	84
Amperex Electronic Corp.	285	Continental Wire Corporation	366
Ampex Corporation	259	Cornell-Dubilier Electric Corp.....	273
A M P, Incorporated	247	Corning Glass Works	82
Amphenol Electronics Corp.	124	Cossor (Canada) Limited	240
Anaconda Wire & Cable Company.....	62, 63	Coto-Coil Co., Inc.	371
Applied Science Corp. of Princeton	271	Crane Packing Co.	241
Arceo Steel Corp.	48	Cross Co., H.	388
Arnold Engineering Co.	13	Crucible Steel Company of America.....	255
Astron Corp.	277		
Atlas Precision Products Co.....	100		
Audio Development Co.	246		
Augat Bros., Inc.	359		
Automatic Mfg. Div. of General Instrument Corp.	105	Dale Products, Inc.	91
Avro Aircraft Limited	300	Damp-Chaser Inc.	419
		Dano Electric Co.	369
		Daven Company	3rd Cover
		Daystrom Instrument	326
		Daystrom Transicoil Corp., A Subsidiary of Daystrom, Inc.	317
		DeJur Amco Corp.	134
		Del Electronics Corp.	328
		Demolab Corporation	71
		DeMornay-Bouardi	96
		Deutsch Company, The	224
		Dialight Corp.	200
		Drakenfeld & Co., Inc., B. F.	379
		Driver Co., Wilbur B.	316
		Driver-Harris Company	58
		Dumont Laboratories, Inc., Allen B.	253
		duPont de Nemours & Co. (Inc.) E. I. Film Dept.	65
		Pigments Dept.	315
		Polychemicals Dept.	47
		E S C Corporation	87
		Eastern Tool & Mfg. Co.....	346
		Edo Corporation	112
		Eitel-McCullough Inc.	38, 297
		Elco Pacific	23
		Electro-Measurements, Inc.	374
Ballantine Laboratories, Inc.	254		
Barry Controls, Inc.	21		
Baso, Inc.	342		
Bausch and Lomb Optical Co.....	296		
Beaver Gear Works, Inc.....	324		
Bell Telephone Laboratories	215		
Bentley Harris Mfg. Co.....	32		
Berkeley Div., Beckman Instruments, Inc.	74		
Bird Electronic Corp.	338		
Biwax Corporation	384		
Bliley Electric Co.	358		
Boehme, Inc., H. O.	370		
Boesch Mfg. Co., Inc.	268		
Bourns Laboratories, Inc.	248		
Bristol Company, The	56, 57		
Burnell & Co., Inc.	9		
Burrroughs Corp.	42		
Bussmann Mfg. Co.	261		
Cambridge Thermionic Corp.	78		
Celco-Constantine Engineering Laboratories, Co.	208, 379		

...when
you
think
of...



TANTALYTIC®
CAPACITORS

think of
Schweber

IN STOCK—OVER 250 DIFFERENT
RATINGS polar and non-polar types.

+85° Designed for high speed
aircraft and missile systems
where quality, long life, and
small size are required.



+125° For
high temperature,
miniaturized high
reliability. Designed for
cramped quarters.

+125°
Permits maximum
flexibility in chassis
arrangement in
minimum space. High
temperature, long
life.



We know you will
appreciate a supplier
who sells TANTALUM
CAPACITORS as a MAIN LINE
instead of a side line! Send for
our latest specially prepared GE
Tantalytic bulletin by filling in
coupon below.



Schweber ELECTRONICS

60 HERRICKS ROAD MINEOLA L I N Y
PIONEER 6-6520

GENTLEMEN:

PLEASE RUSH your specially prepared
1957 GE Tantalytic® Bulletin listing over
250 Tantalum Capacitors in numerical
sequence by microfarads.

COMPANY NAME

ADDRESS

ATTENTION

Circle 334 Readers Service Card

GET THE EXACT TERMINAL YOU NEED AT NEW LOW PRICES!

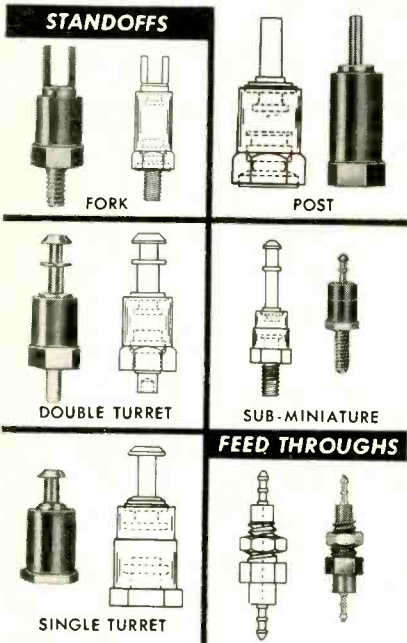

**FROM THE LARGEST
STANDARD and CUSTOM
LINE AVAILABLE...**

Over 100 varieties are furnished as standard. This includes a full range of types, sizes, body materials and plating combinations. Specials can be supplied to any specification. The Whitso line is complete to the fullest extent of every industrial, military and commercial requirement.

Standoff terminals include fork, single and double turret, post, standard, miniature and sub-miniature body types—male, female or rivet mountings—molded or metal base. Feed through terminals are furnished standard or to specification.

Whitso terminals are molded from melamine thermosetting materials to provide optimum electrical properties.

Body Materials: Standard as follows—melamine, electrical grade (Mil-P-14, Type MME); melamine impact grade (Mil-P-14, Type MMI); and phenolic, electrical grade (Mil-P-14, Type MFE).

Plating Combinations: Twelve terminal and mounting combinations, depending on electrical conditions, furnished as standard.

Specials: Body materials and plating combinations, also dimensions, can be supplied to any custom specifications.

**PROMPT DELIVERY IN ECONOMICAL
QUANTITY RUNS**

Get facts on the most complete, most dependable source for terminals and custom molded parts. Request catalog.



9328 Byron Street, Schiller Park, Illinois
(Chicago Suburb)

Circle 335 Readers Service Card

Electro Motive Mfg. Co., Inc.	93
Electro-Snap Switch & Mfg. Co.	267
Electro Tee Corporation	275
Electronic Instrument Co., Inc. (EICO)	350
Electronic Research Associates, Inc.	276
Electronics	138, 139
Elgin National Watch Co., Electronics Division	344
Ellis & Watts Products, Inc.	33
Emerson and Cuming, Inc. 48A, 48B, 48C, 48D	
Empire Devices Products Corporation	423
Engineered Electronics Co.	373
Epsco, Inc.	293
Erie Electronics Division, Erie Resistor Corp.	332, 333
Essex Magnet Wire Div. Essex Wire Corporation	291
Essex Wire Corp., Cords Limited Div.	66
Esterline-Angus Co., Inc.	374
F-R Machine Works Inc.	231
Fairchild Controls Corp.	223
Fansteel Metallurgical Corp.	340, 341
Fenwal, Inc.	90
Film Capacitors, Inc.	114
Filtron Co., Inc.	98
Ford Radio and Mica Corp.	204
Frenchtown Porcelain Co.	345
G-M Laboratories, Inc.	357
Gamewell Co.	228
Gardner-Denver, Keller Tool Div.	245
Garrett Corporation	238, 239
Gates Radio Co.	262
General Ceramics Corp.	361
General Controls	322
General Electric Co.	
Apparatus Dept.	94
Magnetic Materials Section	364
Power Tube Dept.	59
Semiconductor Products Dept.	319
Specialty Electronic Components Dept.	106, 107
Tube Dept.	96A, 96B, 128A, 128B
General Radio Co.	17
Genisco, Inc.	283
Good-all Electric Mfg. Co.	131
Graphic Systems	373
Green Instrument Co.	367
Gries Reproducer Corp.	421
Gudobrod Bros. Silk Co., Inc.	350
Hall Mfg. Co.	377
Hallcrafters Co.	222
Haydon Co., A. W.	214
Haydon Mfg. Co., Inc.	230
Heath Company	304
Heiland, A Div. of Minneapolis-Honeywell	44, 45
Hewlett Packard Company	68, 69, 122, 123
Hexacon Electric Co.	351

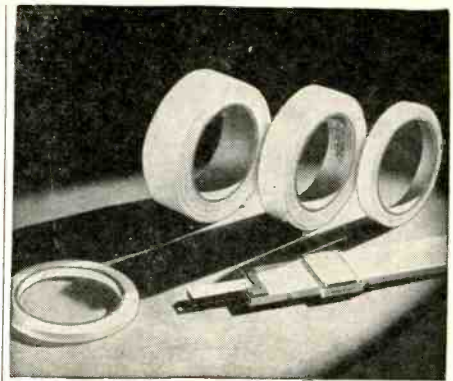

TEMP-R-TAPE PRESSURE-SENSITIVE TEFLON TAPE

TEFLON tape with a silicone polymer adhesive backing. An easy-to-apply Class H insulation for slot lining, bundling, splicing, wrapping. Excellent adhesion, elongation and dielectric over entire -100°F to 400°F temperature range. 6 mil and 13 mil thick in rolls and sheets.

FREE SAMPLE and data sheet.
Write direct or use magazine inquiry card.
CHR THE CONNECTICUT HARD RUBBER CO.
407 EAST STREET • NEW HAVEN • CONN.
SPruce 7-3631
Circle 336 Readers Service Card



Men on the Move

Now available
in a new edition ...
with new figures.

This popular booklet points up the important sales problem of personnel turnover in industry. Out of every 1,000 key men (over a 12-month period) 343 new faces appear ... 65 change titles ... 157 shift ... and 435 stay put. These figures are based on average mailing address changes on a list of over a million paid subscribers to McGraw-Hill magazines.

Write us for a free copy
**Company Promotion Department
McGraw-Hill Publishing Co., Inc.**
330 West 42nd Street,
New York 36, New York

Hoffman Electronics Corp.	119
Hopkins Engineering Co.	420
Horman Associates Inc.	389
Hoyt Electrical Instruments	346
Hudson Tool & Die Co., Inc.	135
Hughes Products, A Div. of Hughes Aircraft Co.	102, 103, 113, 295
Hycor, Division of International Resistance Co.	298
Indium Corp. of America	290
Industrial Test Equipment Co.	354
Institute of Radio Engineers.	331
International Electronic Research Corp.	286
International Nickel Co., Inc.	132
International Rectifier Corp.	213
International Resistance Co.	299
Jadow, Inc., B.	355
Jeffers Electronics Div. Speer Carbon Co.	270
Johnson Company, E. F.	355
Jones Div., Howard B. Cinch Mfg. Co.	388
Kahle Engineering Co.	15
Kaupp & Sons, C. B.	67
Kay Electric Co.	27
Kennedy & Co., D. S.	279
Kepeco Laboratories, Inc.	195
Kester Solder Co.	235
Kinney Mfg. Div., New York Air Brake Co.	339
Kintel (Kay Lab)	51
Klein & Sons, Mathias	46
Krauter & Co., Inc.	372
Krohn-Hite Corp.	421
Lambda Electronics Corp.	301
Lampkin Laboratories, Inc.	388
Lapp Insulator Co., Inc.	206
Lavoie Laboratories, Inc.	118
Leach Corporation	335
Leeds & Northrup Co.	263
Lenkurt Electric Co.	318
Lewis Spring & Mfg. Co.	212
Linde Company, Div. of Union Carbide Corp.	101, 355
Litton Industries	217
Lockheed Aircraft Corp.	327
Loral Electronics Corp.	115
MB Manufacturing Co.	252
MacDonald, Inc., Samuel K.	389
Magnatran Inc.	354
Magnecraft Electric Co.	370
Magnetic Metals Co.	330
Magnetics, Inc.	203
Malco Tool and Mfg. Co.	368
Mallory and Co., Inc., P. R.	140, 193

DIAGNOSE:

hidden danger

of moisture damage to precise electronic, electrical and mechanical equipment.

PRESCRIBE:

DAMPP-CHASER[®]



the new low-surface temperature heater always on guard against destructive moisture.

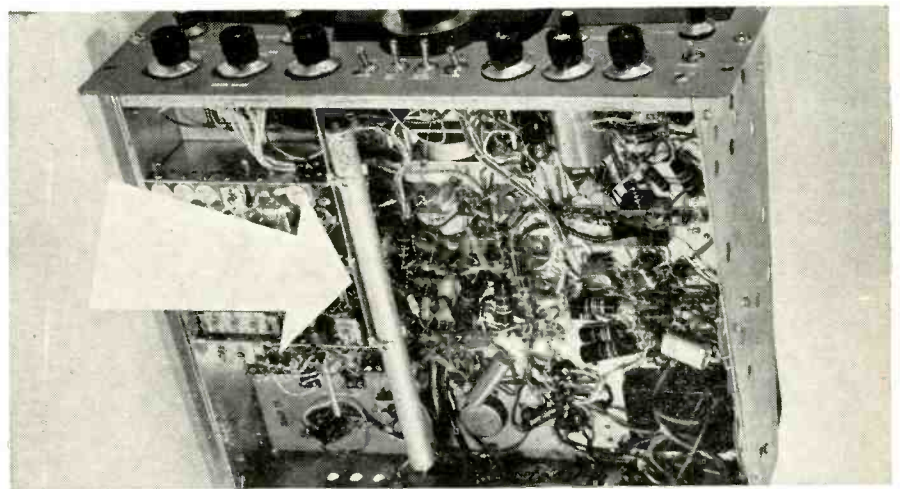

Moisture is the great depreciator. Hard to tell where or when it will strike — but later easy to prove. No sooner has one replacement part restored equipment to service, than another one fails due to moisture attacks.

End moisture with Dampp-Chaser — and end all untimely and critical breakdowns moisture causes even in the most adverse environments. End moisture-caused failures due to leakage in wiring, condensers, insulators, transformer. Dampp-Chaser chases moisture without the danger of creating hot spots. Remember these key features of Dampp-Chaser:

- Gives equipment-wide heat distribution / Low surface temperature 150°F / Low wattage / UL and CSA listed / 5-year guarantee*
- Wide range of shapes, lengths and wattages / Meets Government specs. / Free problem analysis / World-wide distribution.*

For specifications, prices and information, write, wire or phone us today.

DAMPP-CHASER, INC.

General Offices and Plant

P. O. BOX 520, DEPT. E-11 / HENDERSONVILLE, NORTH CAROLINA

Circle 337 Readers Service Card

VIBRATION

HOPKINS HY-THERM CAPACITORS

ARE RIGOROUSLY TESTED IN
OUR LABORATORIES FOR THE
ABILITY TO SERVE BEYOND SPECIFIED REQUIREMENTS

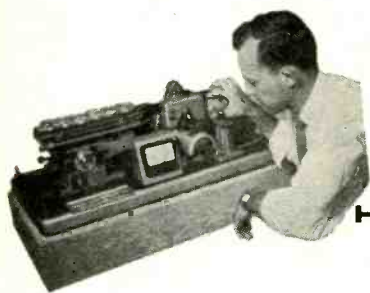

*For Applicable Military Specifications
Meeting or Exceeding Requirements of
MIL-C-25A.*

*Demanding Exceptional Stability and
High Insulation Resistance.*

**WRITE OR WIRE FOR CATALOG
TO-DAY**



HOPKINS *Engineering* COMPANY

12900 FOOTHILL BOULEVARD P. O. Box 191
SAN FERNANDO, CALIFORNIA
EMPIRE 1-8691

Circle 338 Readers Service Card



A copy of this quick-reading, 8-page booklet is yours for the asking. It contains many facts on the benefits derived from your business paper and tips on how to read more profitably. Write for the "WHY and HOW booklet."

**McGraw-Hill Publishing Company, Room 2710, 330 West
42nd St., New York 36, N. Y.**

Mansol Ceramics Co.	375
Manson Laboratories	92
Marconi Instruments, Ltd.	5
McGraw-Hill Book Co.	363, 376
McGraw-Hill Publishing Co.	88
Measurements Corp.	371
Metals & Controls Corp., General Plate Div.	136
Microwave Associates, Inc.	281
Midland Mfg. Co.	60
Millen Mfg. Co., Inc., James.	303
Minneapolis-Honeywell Regulator Co. Davies Laboratories Div.	287
Monsanto Chemical Company	39
Moseley Co., F. L.	210
Mullard Overseas Ltd.	305
Multicore Sales Corp.	110, 111
Mycalex Corp. of America	257

Narda Corporation	79
Nens-Clarke	352
New Hampshire Ball Bearings, Inc.	250
New Hermes Engraving Machine Corp.	351
Ney Company, J. M.	322
Norden-Ketay Corp.	97
North Hills Electric Co., Inc.	373
Nothelfer Winding Laboratories, Inc.	232

Oak Mfg. Co.	85
Offner Electronics, Inc.	312
Ohio-Apex	243
Ohmite Mfg. Co.	233
Operations Research Office	347
Oster Manufacturing Co., John.	309

Panoramic Radio Products, Inc.	312
Perkin-Elmer Corp.	256
Perkin Engineering Corp.	25
Perkins Machine & Gear Co.	349
Permag Corp.	377
Phelps-Dodge Copper Products Corp. Inca Mfg. Div.	52, 53, 221
Phileo Corporation	30, 31
Phillips and Hiss Co., Inc.	378
Pix Manufacturing Co., Inc.	352
Polarad Electronics Corp.	112A, 112B
Polymer Corp. of Penna.	284
Polytechnic Research & Development Co.	137
Popper & Sons, Inc.	422
Potter and Brumfield Inc.	226, 227
Potter Co.	282
Precision Apparatus Co., Inc.	124
Precision Capacitors, Inc.	384
Precision Metal Products Co.	384
Progress Electronics Co.	310
Pulse Engineering	356
Pyle-National Co.	43
Pyramid Electric Co.	307

Radiation, Inc.	258
Radio Corporation of America	260, 4th Cover
Radio Engineering Products	353
Radio Frequency Laboratories, Inc.	266
Radiometer	377
Radio Receptor Co., Inc.	133, 211
Ramo-Wooldridge Corp.	237
Raybestos-Manhattan, Inc.	70
Ratheon Mfg. Company	18, 19, 34, 35, 249 269, 381, 383, 385, 387
Relay Sales, Inc.	55
Revere Corp. of America	294
Rex Rheostat Co.	356
Royal Metal Mfg. Co.	353

Sanborn Company	76, 77
Schweber Electronics	417
Sealectro Corp.	320
Shalleross Mfg. Co.	220
Shell Chemical Co.	199
Sierra Electronic Corp.	37
Simpson Electric Company	126, 127
Sola Electric Co.	128
Sorensen & Co., Inc.	4
Southern Electronic Corp.	241
Southwestern Industrial Electronics Co.	265
Specific Products	292
Sperry Gyroscope Company, Division of Sperry Rand Corp.	81
Sprague Electric Co.	11
Stackpole Carbon Co.	75
Staedtler Inc., J. S.	129
Sterling Transformer Corp.	329
Stevens Arnold, Inc.	359
Stromberg-Carlson Company	219, 369
Superior Electric Company	125
Superior Tube Co.	80
Sylvania Electric Products, Inc.	120, 130 64A, 64B, 64C, 64D

Taylor Fibre Co.	64
Teclnitrol Engineering Co.	358
Tektronix, Inc.	61
Telrex Laboratories	318
Tensolite Insulated Wire Co., Inc.	343
Texas Instruments Incorporated	201
Thermal American Fused Quartz Co., Inc.	378
Transitron Electronic Corp.	207
Transformers, Incorporated	49
Transradio Ltd.	357
Triad Transformer Corp.	314
Tung-Sol Electric, Inc.	218
Ucinite Co.	50
Union Switch & Signal Div. of Westing- house Air Brake Company	336, 337
U. S. Stoneware	89
United Transformer Co.	2nd Cover

REGULATED POWER SUPPLY

with 100 Microvolts Hum

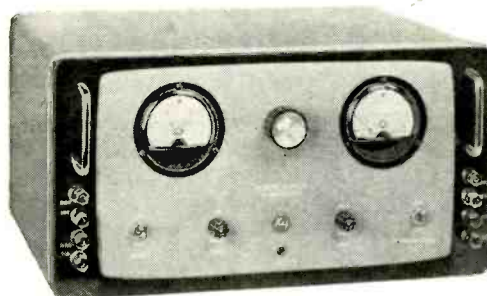

Model UHR-245

Krohn-Hite Model UHR-245 ULTRA-HIGH REGULATION POWER SUPPLY furnishes continuously variable voltage from 150 to 500 volts and delivers up to $\frac{1}{2}$ ampere of DC current with 0.002% load regulation and less than 100 microvolts of ripple over the ENTIRE OPERATING RANGE. The internal impedance is less than 0.01 ohm for DC and low frequencies and less than 0.05 ohm for frequencies as high as 50 kc. Full rated maximum current can be drawn with 100% duty cycle at any output voltage and at any line voltage from 105 to 125 volts with a substantial safety factor. There are two independent 6.3 volt AC 10 ampere outputs. Price \$425.00 f.o.b. factory.

For Further Details Write

KROHN-HITE CORPORATION

Dept. E, 580 Massachusetts Ave., Cambridge 39, Mass.

Circle 339 Readers Service Card

new designs on the board?

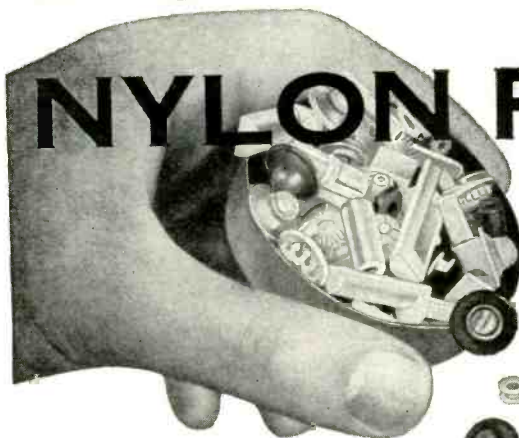

Gries' unique single cavity molding facilities are flexible—provide the practical answer to countless problems of product design and improvement. No matter how tiny, or how intricate, GRC molds nylon parts to meet your exact specifications, with precise tolerances and uniform quality. And, because GRC methods are completely automatic, costs are surprisingly low—GRC tiny nylon parts are produced completely trimmed and ready for use, in one high-speed, money-saving operation!

Write today for Bulletin. Send prints for quotation. Be sure to see GRC at the Metal Show

BOOTH 1343



GRIES REPRODUCER CORP.

World's Foremost Producer of Small Die Castings
151 Beechwood Ave., New Rochelle, N. Y. Phone: NEw Rochelle 3-8600

Circle 340 Readers Service Card

GRC

TINY MOLDED

NYLON PARTS

may be the difference between "problems" and profits!

GRC MOLDS ALL THERMOPLASTICS SWIFTLY, DEPENDABLY, ECONOMICALLY!

Automatic Continuous and Individual Inserts! Single Parts!

Quick deliveries on quantities of 25,000 to millions.

NO SIZE TOO SMALL!

MAXIMUM SIZE .03 ozs.—1 $\frac{1}{4}$ " long.

LOW MOLD COSTS!

Precision in miniature

AUDIO OSCILLATOR

MODEL 510B



\$150.

4 1/4"

Write for full catalog—DELIVERY FROM STOCK

- 18cps—1.1MC
- 2% calibration accuracy
- 10V output
- $\pm 1/2$ db frequency response
- Less than 2/10% distortion
- Less than 2 millivolt noise
- 6" x 4 1/4" panel area
- 6 lbs weight

A PRECISION SINE-WAVE source available as a portable, rack, or panel mounted instrument. Its operation is unaffected by line voltage (105-130V) or frequency (50-400 cps).

For balanced output, two MATCHING TRANSFORMER units are available as optional equipment. These are in cases which attach permanently to the bottom of the 510B.

	TRANSFORMER T10	TRANSFORMER T11
output level.....	+8dbm.....	+10dbm.....
impedance.....	150/600.....	135/600.....
range.....	20-50,000 cps.....	20-200,000 cps.....
price.....	\$40.....	\$90.....



"Precision in miniature" ELECTRONIC INSTRUMENTS

333 Sixth Avenue, New York 14
WAtkins 9-2795

Circle 341 Readers Service Card



Circle 342 Readers Service Card

FOR PRINTING
of
ELECTRONIC COMPONENTS
of almost any shape:

REJAFIX MARKING MACHINES

Hand-operated, semi-automatic and fully automatic models.

Why not send us samples of your products. They will be test-printed and returned to you for your examination!

Est. 1922

POPPER & SONS, INC.

300 Fourth Ave. New York 10, N. Y.

Van Keuren Co., The.....	371
Varian Associates.....	289
Varo Mfg. Co., Inc.....	375
Veeder-Root, Inc.....	104
Victoreen Instrument Co.....	216

Waldes Kohinoor, Inc.....	83
Waldorf Instrument Co.....	313
Wales Strippit Co.....	109
Waltham Precision Instrument Co.....	386
Ward Leonard Electric Co.....	95
Waterman Products Co., Inc.....	280
Waters Manufacturing, Inc.....	302
Wave Forms Inc.....	422
Weckesser Co.....	356
Western Electric Co.....	311
Westinghouse Electric Corp.....	28, 29, 117, 376
Weston Electrical Instrument Corp., A Subsidiary of Daystrom, Inc.....	209
Wheelock Signals, Inc.....	367
White Dental Mfg. Co., S. S.....	308, 382
Whitso Inc.....	418

Zell Products Corp.....	348, 349
Zophar Mills, Inc.....	375

MANUFACTURERS REPRESENTATIVES.....	389
------------------------------------	-----

PROFESSIONAL SERVICES.....	389
----------------------------	-----

CLASSIFIED ADVERTISING
F. J. Eberle, Business Mgr.

EMPLOYMENT OPPORTUNITIES.....	390-403
-------------------------------	---------

EDUCATIONAL.....	408
------------------	-----

BUSINESS OPPORTUNITIES.....	408
-----------------------------	-----

EQUIPMENT (Used or Surplus New) For Sale.....	404-416
---	---------

WANTED.....	408
-------------	-----

McGraw-Hill Mailing Lists Will Help You



Mc GRAW-HILL
DIRECT MAIL LIST SERVICE

- Merchandise your advertising
- Conduct surveys
- Get inquiries and leads for your salesmen
- Pin-point geographical or functional groups
- Sell Direct
- Build up weak territories
- Aid Dealer relations

Direct Mail is a necessary supplement to a well rounded Business Paper advertising program.

Most progressive companies allocate a portion of their ad budgets to this second medium at the same time as they concentrate on the best business publications. 600,000 of the top buying influences in the fields covered by the McGraw-Hill publications make up our 150 mailing lists. Pick Your prospects out of our Industrial Direct Mail catalogue.

Write for your free copy. It contains complete information.

EMPLOYMENT OPPORTUNITIES
ADVERTISERS

Abbott's Employment Specialists.....	398
Aircraft Radio Corp.....	403
Bendix Aviation Corp	
Products Division—Missiles.....	390
York Division	403
Boonton Radio Corp.....	402
Burroughs Corp, Research Center.....	397
Chance Vought Aircraft Inc.....	392, 393
Cooper, J. J.....	402
Federal Telecommunications Labs.....	401
Fidelity Personnel Service.....	402
General Electric Co.....	396, 399
Goodyear Aircraft Corp	
Akron, Ohio	395
Litchfield Park, Arizona.....	401
Industro Corp	403
International Business Machines Corp....	391
Lear Inc	400
Linde Co, Div. of Union Carbide Corp....	403
Magnetics Inc	402
Maryland Electronics Manufacturing.....	394
Melpar Inc	396
Monarch Personnel	402
Motorola Inc	
Chicago, Ill	398
Phoenix, Arizona	390
Northrop Aircraft Inc.....	400
Sanders Associates Inc.....	400
Stavid Engineering	403
Stromberg Carlson Co., Div of General Dy- namics Corp	399
Tung-Sol Electronic, Inc.....	402
Westinghouse Electronic Tube Division....	394

SEARCHLIGHT SECTION ADVERTISERS

Alltronics-Howard Co	415
Alvaradio Industries Inc.....	413
Arrow Sales Inc.....	411

MEASURE NOISE AND FIELD INTENSITY FROM 150 KC TO 1000 MC— WITH ONE METER!

Quickly • Accurately • Reliably

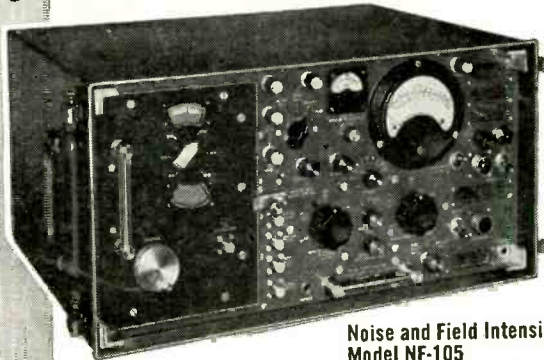

Noise and Field Intensity Meter
Model NF-105
(Commercial Equivalent of AN/URM-7)



TA/NF-105:
150 KC-30MC



T1/NF-105:
20-200MC



T2/NF-105:
200-400MC

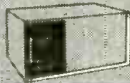

T3/NF-105:
400-1000MC

Empire Devices Noise and Field Intensity Meter Model NF-105 permits measurements of RF interference and field intensity over the entire frequency range from 150 kilocycles to 1000 megacycles. It is merely necessary to select one of four individual plug-in tuning units, depending on the frequency range desired. Tuning units are readily interchangeable... can be used with all Empire Devices Noise and Field Intensity Meters Model NF-105 now in the field.

Each of the four separate tuning units employs at least one RF amplifier stage with tuned input. Calibration for noise measurements is easily accomplished by means of the built-in impulse noise calibrator. With this instrument costly repetition of components common to all frequency ranges is eliminated because only the tuners need be changed. The same components... indicating circuits, calibrators, RF attenuators, detectors and audio amplifier... are used at all times.

Noise and Field Intensity Meter Model NF-105 is accurate and versatile, it may be used for measuring field intensity, RF interference, or as an ultra-sensitive VTVM. A complete line of accessories is available.

For complete performance data, send for Catalog No. N-356

NEW YORK—Digby 9-1240 • SYRACUSE—Granit 4-7409 • PHILADELPHIA—
Sherwood 7-9080 • BOSTON—TWmbrook 4-1955 • WASHINGTON, D. C.—
Decatur 2-8000 • ATLANTA—Cedar 7-7801 • DETROIT—Broadway 3-2900
• CLEVELAND—Evergreen 2-4114 • PITTSBURGH—Atlantic 1-9248 • ST.
LOUIS—Evergreen 5-7728 • DAYTON—Fulton 8794 • CHICAGO—Eslerbrook
9-2700 • DENVER—Main 3-0343 • FORT WORTH—Walnut 8-4414 •
HOUSTON—Mohawk 7-6100 • ALBUQUERQUE—Albuquerque 5-9632 • LOS
ANGELES—Republic 2-8103 • PALO ALTO—Davenport 3-4455 • PORTLAND—
Capitol 7-3830 • CANADA: SPITTSVILLE, ONT.—Lazeldean 56 • EXPORT:
NEW YORK—Murray Hill 2-3760

EMPIRE DEVICES
PRODUCTS CORPORATION
AMSTERDAM, NEW YORK

Telephone: Victor 2-8400

manufacturers of

FIELD INTENSITY METERS • DISTORTION ANALYZERS • IMPULSE GENERATORS • COAXIAL ATTENUATORS • CRYSTAL MIXERS

Circle 343 Readers Service Card

**1/2%
MULTIPLIERS**

**MIRRORED-SCALE
1%
METER**

**POLARITY
REVERSAL
SWITCH**

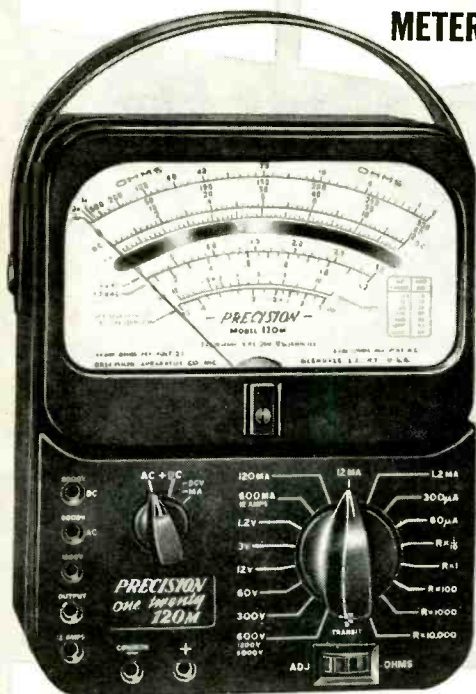

... all in the **NEW**
PRECISION
model **120M**
MIRRORED-SCALE
20,000 Ω/V DC 5,000 Ω/V AC
V·O·M

for
**OUTSTANDING
ACCURACY**
in all
**INDUSTRIAL
APPLICATIONS**

The Model 120M incorporates every desirable feature and all of the wide-spread ranges of the famous **PRECISION** Model 120 — PLUS the combination of special features headlined above, which are found only in the 120M.

Especially engineered for the really critical test equipment user, the 120M incorporates selected high-accuracy multipliers, shunts and meter to provide $\pm 1\frac{1}{2}\%$ accuracy on DC and $\pm 3\%$ accuracy on AC.

The 1% mirrored-scale PACE meter incorporates the most advanced design features to assure the utmost stability and accuracy. The mirrored scale permits the most accurate meter readings by eliminating parallax. The polarity reversing switch simplifies the testing of complex electronic circuits. Test point polarity is automatically indicated by the switch position.

Compare These Wide-Spread Ranges and Special Features:

- ▶ **MORE RANGES** — 44 of them... starting lower and going higher — outranging any other professional V·O·M of similar size or type.
- ▶ **EXTRA-LOW RESISTANCE RANGE** — 2-ohm center scale.
- ▶ **EXTRA-LOW VOLTAGE RANGE** — 1.2 full scale, AC and DC.
- ▶ **EXTRA-LOW CURRENT RANGE** — 60 μA DC at full scale.
- ▶ **LARGER AND EASIER-READING SCALES** — extra-large 5¼" PACE meter.
- ▶ **POSITIVE CONTACT JACKS and PLUGS** — solid brass, banana type.

- * **8 DC VOLTAGE RANGES:** 20,000 ohms per v. 0-1.2-3-12-60-300-600-1200-6000v.
- * **8 AC VOLTAGE RANGES:** 5,000 ohms per v. 0-1.2-3-12-60-300-600-1200-6000v.
- * **8 OUTPUT RANGES:** same as AC ranges.
- * **7 DC CURRENT RANGES:** 0-60-300 microamps 0-1.2-12-120-600 ma. 0-12 amps.
- * **5 RESISTANCE RANGES:** self-contained. 0-200-2000-200,000 ohms; 0-2-20 megohms.
- * **8 DECIBEL RANGES,** from -20 to +77 DB. (0 DB=1 MW, 600 ohms.)
- * **EXTRA-LARGE 5¼" RUGGED 'PACE' METER:** 50 microamperes sensitivity, 1% accuracy.
- * **½% MULTIPLIERS and SHUNTS.**
- * **"TRANSIT" SAFETY SWITCH** protects meter during transportation and storage.
- * **CUSTOM-MOLDED CASE AND PANEL** with deeply engraved, highly legible numerals.



... and STILL
THE TOP V·O·M
at \$44.95

The Popular
PRECISION 120
model

Model 120M: complete with internal ohmmeter batteries, banana-plug test leads and operating manual. Over-all case dimensions: 5¾ x 7 x 3½ inches. **NET PRICE: \$52.95**

LC-3: top grain leather ever-ready case for 120M. **NET PRICE: \$9.50**

AVAILABLE AT ALL LEADING
ELECTRONIC PARTS DISTRIBUTORS

PRECISION Apparatus Company, Inc.
70-31 84th Street, Glendale 27, L. I., N. Y.

Export: 458 Broadway, New York 13, N.Y., U.S.A. • Cables: MORHANEX
Canada: Atlas Radio Corp. Ltd. • 50 Wingold Ave. • Toronto 10, Ont.

Barry Electronics Corp.....	407, 408
Belvision Inc.....	413
Blan	414
C & H Sales Co.....	409
Candee Co., J. J.....	415
Communications Equipment Co.....	405
Compass Electronic Supply Co.....	412
Discophone Sales Co.....	415
Fay-Bill Distributing Co.....	408
Freeland Products Co.....	412
JSH Sales Co.....	404
Electronics Research Laboratories.....	410
Legri-S Co.	412
Liberty Electronics Inc.....	411
M. & R. Co., The.....	411
Monmouth Radio Labs.....	406
Montgomery Equipment Co.....	414
Narda Ultrasonic Corp.....	408
Pacific International University.....	408
Radalab Inc.	405
Radio Research Instrument Co.....	415
Raway Hearing Co.....	412
"TAB"	416
Telephone Engineering Co.....	415
Universal Relay Corp (formerly Universal General Corp).....	406
V & H Radio & Electronics.....	413
Western Engineers	410
Wiigreen Industries	410

This index is published as a service. Every care is taken to make it accurate, but ELECTRONICS assumes no responsibility for errors or omissions.

The INCREDIBLE SHRINKING RESISTOR...

Daven has always been the leader in the miniaturization of precision wire wound resistors. Now, due to further advances in resistor manufacture, Daven is able to offer higher resistance values in smaller sizes than ever before. Typical miniature units, with their new maximum values, are tabulated here.

For guided missiles, airborne radar, telemetering, and for any application where extremely small size

and dependability are of prime importance, specify Daven miniature wire wounds.

TYPE	DIAM	LENGTH	MAX WATTS	MAX OHMS
1250	1/4	1/2	.33	1 Megohm
1274	3/16	3/8	.25	250 K
1284	1/4	27/64	.25	1 Megohm

THE **DAVEN** CO.



LIVINGSTON, NEW JERSEY

TODAY, MORE THAN EVER, THE DAVEN © STANDS FOR DEPENDABILITY!

New RCA Beam Power Tubes With New High-Efficiency Radiator

RCA-7034/4X150A

with 6V, 2.6A Heater

RCA-7035/4X150D

with 26.5V, 0.58A Heater



Higher Power Output... 370 Watts up to 150 Mc

Higher Plate Dissipation... 250 Watts up to 500 Mc

Unilaterally interchangeable with the 4X150A and 4X150D, these superior new RCA tubes feature a new specially designed, high-efficiency radiator which is hard soldered directly to the plate for better heat transfer. The 7034 and 7035 offer substantially higher power output capability at frequencies up to 150 Mc, and reliable operation with higher plate dissipation at frequencies up to 500 Mc.

Small and compact, the RCA-7034/4X150A and the RCA-7035/4X150D are useful as af power amplifiers and modulators, wide-band amplifiers in video applications, linear rf power amplifiers in single-sideband suppressed-carrier equipment, and class C amplifiers or oscillators.

Your RCA Field Representative at the RCA Office nearest you will be glad to give you sales information on these new types. For technical bulletin on RCA-7034/4X150A and RCA-7035/4X150D, write RCA Commercial Engineering, Section K-19-Q-1, Harrison, N. J.

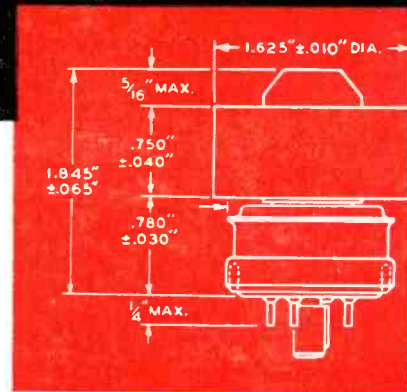

TYPICAL CCS OPERATION		
RF Power Amp. & Osc.—Class C Telegraphy		
Up to 150 Mc.		
DC Plate Volts	1500	2000
DC Plate Ma.	250	250
Driving Power (watts)	1.5	2.5
Power Output (watts)	260	370
At 500 Mc.		
DC Plate Volts	600	1250
DC Plate Ma.	170	200
Driver Power Output (watts)	15	30
Useful Power Output (watts)	50	140

RCA Field Offices

- East:** Humboldt 5-3900
744 Broad Street, Newark 2, N. J.
- Midwest:** Whitehall 4-2900—Suite 1181
Merchandise Mart Plaza, Chicago 54, Illinois
- West:** RAYmond 3-8361—6355 E.Washington Blvd
Los Angeles 22, California



RADIO CORPORATION OF AMERICA

Electron Tube Division • Harrison, N. J.